

FLIGHT MANUAL

USAF SERIES

A-10A

AIRCRAFT

Serno 75-00258 and subsequent

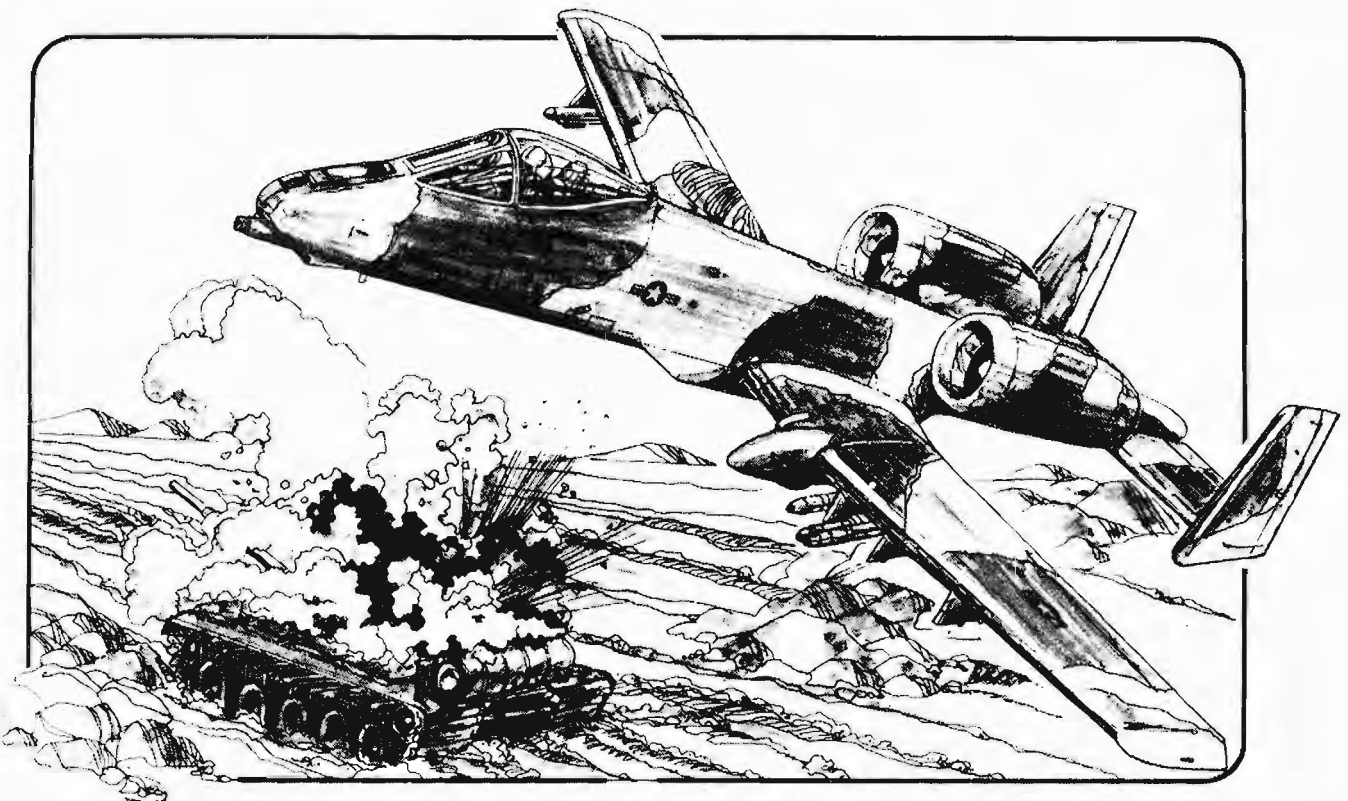

This manual is incomplete without TO 1A-10A-1-1.

This manual incorporates supplements TO 1A-10A-1SS-20, 1S-49, 1S-52, 1S-53, 1S-54, 1S-56, 1SS-57, 1SS-59, 1SS-60, 1SS-62, 1S-64, 1S-65, 1S-67 and 1SS-68.

DISTRIBUTION STATEMENT - Distribution authorized to US Government agencies only for administrative or operational use (15 March 1988). Other requests for this document shall be referred to Sacramento ALC/MMEDTD, McClellan AFB CA 95652-5609.

HANDLING AND DESTRUCTION NOTICE - Handle in compliance with distribution statement and destroy by any method that will prevent disclosure of the contents or reconstruction of the document.

COMMANDERS ARE RESPONSIBLE FOR BRINGING THIS PUBLICATION TO THE ATTENTION OF ALL PERSONNEL CLEARED FOR OPERATION OF SUBJECT AIRCRAFT.

Published under authority of the Secretary of the Air Force

20 FEBRUARY 1983
CHANGE 8 - 15 MARCH 1988

LIST OF EFFECTIVE PAGES

NOTE: The portion of the text affected by the changes is indicated by a vertical line in the outer margins of the page. Changes to illustrations are indicated by miniature pointing hands. Changes to wiring diagrams are indicated by shaded areas.

TOTAL NUMBER OF PAGES IN THIS PUBLICATION IS 400, CONSISTING OF THE FOLLOWING:

Page No.	*Change No.	Page No.	*Change No.	Page No.	*Change No.
Title	8	1-47	0	1-120 - 1-126	0
A - B	8	1-48	1	1-127	1
C Blank	8	1-49	8	1-128	0
i - ii	0	1-50 - 1-51	0	1-129	7
iii - iv	8	1-52	8	1-130 - 1-132	0
v	7	1-52A	7	1-133 - 1-134	8
vi	8	1-52B Blank	7	1-134A - 1-134G Added	8
viA Added	8	1-53	7	1-134H Blank Added	8
viB Blank Added	8	1-54	1	1-135 - 1-139	0
vii	0	1-55 - 1-58	0	1-140	8
viii Blank	0	1-59	8	1-141 - 1-142	0
1-1	1	1-60 Blank	8	1-143	8
1-2	0	1-61	3	1-144	2
1-3	7	1-62	8	1-145	8
1-4	0	1-63 - 1-64	6	1-146 - 1-147	0
1-5	6	1-65	8	1-148	7
1-6 - 1-10	0	1-66	5	1-149 - 1-150	8
1-11	6	1-67	8	1-150A	8
1-12	7	1-68 - 1-69	0	1-150B Blank	8
1-13	0	1-70	1	1-151	8
1-14 - 1-15	8	1-71 - 1-72	0	1-152 - 1-153	0
1-16 - 1-17	0	1-73	8	1-154 - 1-155	8
1-18 - 1-18A	1	1-74 - 1-76	0	1-156 - 1-157	0
1-18B Blank	1	1-77	8	1-158 - 1-159	8
1-19	8	1-78 - 1-79	0	1-160 - 1-164	0
1-20	6	1-80	1	1-165 - 1-166	7
1-20A	8	1-81 - 1-83	0	1-166A Added	7
1-20B Blank	8	1-84	8	1-166B Blank Added	7
1-21	0	1-85	6	1-167	6
1-22	0	1-86 - 1-87	0	1-168 - 1-169	7
1-23	0	1-88	6	1-170 - 1-172	0
1-24	8	1-89 - 1-90A	1	1-173	2
1-25	1	1-90B Blank	1	1-174	7
1-26	0	1-91	6	2-1 - 2-2	6
1-27	8	1-92	1	2-3	8
1-28	2	1-93	0	2-4	7
1-29	7	1-94	6	2-5	6
1-30 - 1-37	0	1-95	1	2-6 - 2-6A	7
1-38	2	1-96 - 1-107	0	2-6B Blank	7
1-39 - 1-42	0	1-108 - 1-109	1	2-7	6
1-43	8	1-110 - 1-113	0	2-8 - 2-8A	3
1-44 - 1-45	0	1-114 - 1-115	1	2-8B Blank	3
1-46 - 1-46A	2	1-116	0	2-9 - 2-10	8
1-46B Blank	2	1-117 - 1-119	1	2-10A	8

*Zero in this column indicates an original page

LIST OF EFFECTIVE PAGES

Page No.	*Change No.	Page No.	*Change No.	Page No.	*Change No.
2-10B Blank	8	3-35 - 3-36	8	6-2A	1
2-11	8	3-36A	7	6-2B Blank	1
2-12	1	3-36B Blank	7	6-3	8
2-12A	8	3-37 - 3-38	7	6-4	2
2-12B Blank	8	3-38A	8	6-5	0
2-13 - 2-14	8	3-38B Blank	8	6-6	7
2-14A	7	3-39 - 3-40	7	6-6A	6
2-14B Blank	7	3-40A	7	6-6B Blank	6
2-15 - 2-20	8	3-40B Blank	7	6-7	7
2-21	7	3-41	6	6-8	0
2-22	2	3-42	7	6-9	3
2-23	3	3-42A	8	6-10 - 6-10B	7
2-24	2	3-42B	6	6-11	1
2-25 - 2-26	6	3-42C	1	6-12	8
3-1 - 3-2	8	3-42D Blank	1	6-13	2
3-2A - 3-2B	1	3-43	3	6-14 Blank	2
3-3	1	3-44	6	7-1	0
3-4 - 3-4A	3	3-45	7	7-2	7
3-4B Blank	3	3-46	1	7-3	0
3-5	7	3-47	8	7-4 - 7-4A	3
3-6 Blank	7	3-48	1	7-4B Blank	3
3-7	8	4-1	0	7-5 - 7-6	7
3-8	7	4-2 Blank	0	Glossary 1	0
3-8A	8	5-1	1	Glossary 2	6
3-8B Blank	8	5-2	8	Index 1 - Index 8	3
3-9	3	5-2A Added	7	Index 9	1
3-10	7	5-2B Blank Added	7	Index 10	3
3-10A Deleted	3	5-3	8	FO-1	6
3-10B Blank Deleted	3	5-4	0	FO-2 Blank	6
3-11	7	5-5	1	FO-3	0
3-12	8	5-6	0	FO-4 Blank	0
3-13	6	5-7	7	FO-5	6
3-14	3	5-8	0	FO-6 Blank	6
3-15	7	5-8A	1	FO-7	1
3-16	8	5-8B Blank	1	FO-8 Blank	1
3-16A Deleted	3	5-9	7	FO-9	0
3-16B Blank Deleted	3	5-10 - 5-12	0	FO-10 Blank	0
3-17	8	5-13	8	FO-11	4
3-18	3	5-14 - 5-15	0	FO-12 Blank	4
3-19	1	5-16	2		
3-20	7	5-17	8		
3-21	3	5-18	1		
3-22	7	5-19	0		
3-22A - 3-22B	8	5-20 - 5-21	1		
3-23	3	5-22	2		
3-24	6	5-23 - 5-26	8		
3-24A - 3-24B	8	5-27	7		
3-25 - 3-27	8	5-28 - 5-31	8		
3-28	0	5-32 - 5-48 Deleted	1		
3-29	3	5-49	1		
3-30	7	5-50	8		
3-31	0	5-51 Added	8		
3-32 - 3-33	6	5-52 Blank Added	8		
3-34	3	6-1 - 6-2	2		

*Zero in this column indicates an original page

Reflect TO 1A-10A-1SS-72

Change 8

B/(C Blank)

TABLE OF CONTENTS

SECTION I	Description	1-1
SECTION II	Normal Procedures	2-1
SECTION III	Emergency Procedures	3-1
SECTION IV	Crew Duties	N/A
SECTION V	Operating Limitations	5-1
SECTION VI	Flight Characteristics	6-1
SECTION VII	Adverse Weather Operation	7-1
Glossary	Glossary	Glossary 1
Index	Alphabetical Index	Index 1
Foldouts		FO-1
Appendix I	Performance Data	T.O. 1A-10A-1-1



AND

READ

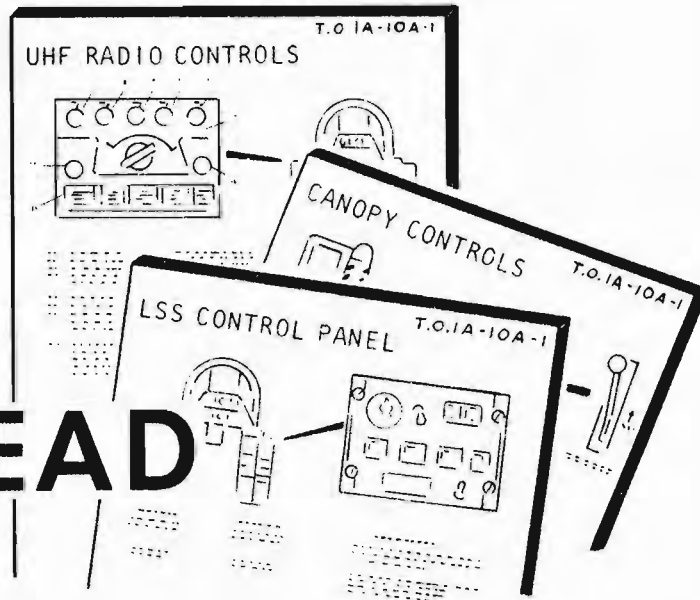

SCOPE

This manual contains the necessary information for safe and efficient operation of your aircraft. These instructions provide you with a general knowledge of the aircraft and its characteristics and specific normal and emergency operating procedures. Your experience is recognized; therefore, basic flight principles are avoided. Instructions in this manual are for a crew inexperienced in the operation of this aircraft. This manual provides the best possible operating instructions under most circumstances. Multiple emergencies, adverse weather, terrain, etc., may require modification of the procedures.

PERMISSIBLE OPERATIONS

The flight manual takes a "positive approach" and normally states only what you can do. Unusual operations or configurations are prohibited unless specifically covered herein. Clearance must be obtained before any questionable operation, which is not specifically permitted in this manual, is attempted.

HOW TO BE ASSURED OF HAVING LATEST DATA

Refer to T.O. 0-1-1-5 for information concerning current flight manuals, safety supplements, operational supplements, and checklists. Also, check the flight manual cover page, the title block of each safety and operational supplement, and all status pages contained in the flight manual or attached to formal safety and operational supplements. Clear up all discrepancies before flight.

ARRANGEMENT

The manual is divided into seven independent sections to simplify reading it straight through or using it as a reference manual.

SAFETY SUPPLEMENTS

Information involving safety will be promptly forwarded to you in a safety supplement. Supplements covering loss of life will get to you within 48 hours by teletype, and supplements covering serious damage

to equipment within 10 days by mail. The cover page of the flight manual and the title block of each safety supplement should be checked to determine the effect they may have on existing supplements.

OPERATIONAL SUPPLEMENTS

Information involving changes to operating procedures will be forwarded to you by operational supplements. The procedure for handling operational supplements is the same as for safety supplements.

MAJCOM T.O.1A-10A-1 FLIGHT MANUAL REVIEW CONFERENCE (FMRC)

The Interim/Formal Safety/Operational supplements listed on the Title Page were incorporated as written or the intent was incorporated as determined by the MAJCOMs during the FMRC.

CHECKLISTS

The flight manual contains itemized procedures with necessary amplifications. The checklist contains itemized procedures without the amplification. Primary line items in the flight manual and checklist are identical. If a formal safety or operational supplement affects your checklist, the affected checklist page will be attached to the supplement.

HOW TO GET PERSONAL COPIES

Each flight crew member is entitled to personal copies of the flight manual, safety supplements, operational supplements, and checklists. The required quantities should be ordered before you need them to insure their prompt receipt. Check with your publication distribution officer — it is his job to fulfill your T.O. requests. Basically, you must order the required quantities on the appropriate Numerical Index and Requirement Table (NIRT). T.O. 00-5-1 and 00-5-2 give detailed information for properly ordering these publications. Make sure a system is established at your base to deliver these publications to the flight crew immediately upon receipt.

FLIGHT MANUAL BINDERS

Looseleaf binders and sectionalized tabs are available for use with your manual. They are obtained through

local purchase procedures and are listed in the Federal Supply Schedule (FSC Group 75, Office Supplies, Part 1). Check with your supply personnel for assistance in procuring these items.

DEFINITION OF WORDS "SHALL," "WILL," "SHOULD" AND "MAY"

The words "shall" and "will" indicate a mandatory requirement. The word "should" indicates a non-mandatory desire or preferred method of accomplishment. The word "may" indicates an acceptable or suggested means of accomplishment.

WARNINGS, CAUTIONS AND NOTES

The following definitions apply to "Warnings", "Cautions" and "Notes" found throughout the manual.

WARNING

Operating procedures, techniques, etc., which will result in personal injury or loss of life if not carefully followed.

CAUTION

Operating procedures, techniques, etc., which will result in damage to equipment if not carefully followed.

NOTE

An operating procedure, technique, etc., which is considered essential to emphasize.

YOUR RESPONSIBILITY — TO LET US KNOW

Every effort is made to keep the flight manual current. Review conferences with operating personnel and a constant review of accident and flight test reports assure inclusion of the latest data in the manual. We cannot correct an error unless we know of its existence. In this regard, it is essential that you do your part. Comments, corrections, and questions regarding this manual or any phase of the flight manual program are welcomed. These should be forwarded through your command channels on AF Form 847 to: SM-ALC/MMSRB, McClellan AFB, California 95652.

TCTO IDENTIFICATION

The following TCTOs affecting A-10 Airplanes are covered in this manual. This is not a complete listing and only includes TCTOs listed by number directly affecting this manual. Refer to the Numerical Index and Requirement Table (TO 0-1-1-5) for complete listing of TCTOs for these airplanes.

TO NUMBER	DISPOSITION SECTION	SUBJECT
1A-10-649	I, II	Install AAU-34/A Altimeter
1A-10-670	I	Revise Cabin Air Distribution System
1A-10-764	I, II, III, V	Chaff/Flare Dispensers
1A-10-831	I	Modification of Emergency Canopy Actuator Unlock Assembly
1A-10-869	I	APU Ground Shutoff
1A-10-883	I	Addition of Time Delay in Jam Indication System
1A-10-901	I	Modification of Wing Flap Control System
1A-10-932	I, III, VI	Incorporation of HARS/SAS Attitude Validity Assembly into A-10 Aircraft
1A-10-975	I, II, III	Incorporation of An Inertial Navigation System in A-10 Aircraft
1A-10-986	I	Continuous Ignition During Stall Warning and Gunfiring
1A-10-1059	I	Installation of GFU-16A Gun Gas Diverter System, A-10A Aircraft and GA-10A
1A-10-1084	I	Installation of Canopy Jettison Handle Decal, A-10 Aircraft
1A-10-1087	I	New Air Force Serial Numbers for Option IX A-10 Aircraft
1A-10-1154	I, III, V, VII	Installation of TF34-GE-100A Engines and Replacement of Aircraft Cockpit Engine Temperature Indicators A-10A Aircraft
1A-10-1158	I, II, V	Installation and Operational Checkout of the Turbine Engine Monitoring System (TEMS) Line Replaceable Units (LRU), A-10A Aircraft
1A-10-1170	I	Reconfiguration of Cockpit Right Console
1A-10-1176	I, II	Installation of Airborne Video Tape Recorder (AVTR) and Cockpit Television Sensor (CTVS) Retrofit
1A-10-1177	I, II, V	Incorporation of Self Defense Air-To-Air AIM-9 Missile Capability, A-10 Aircraft
1A-10-1186	I	Modification of Air Refueling Line
1A-10-1195	I	Installation of Electroluminescent Formation Lights
1A-10-1216	I	Modification of Canopy Jettison Handle
1A-10-1227	I	Alternate Closure of 65PSI Valve, A-10 Aircraft
1A-10-1228	I	Install a "SEAT NOT ARMED" indication system on ACES II Ejection Seats, A-10A and OA-10 Aircraft
1A-10-1243	I, II	Installation of Air Force Seawater Activated Release System (SEAWARS), A-10 ACES II Parachutes P/N J114-509-517
1A-10-1250		A-10 Stall Warning for Approach and Landing
1A-10-1267	I	Install HAVE QUICK II on A-10 Aircraft

EFFECTIVITY PAGE

- 1 Aircraft sernos 76-0519 through 76-0520.
- 3 Aircraft not modified by T.O. 1A-10-986.
- 4 Aircraft serno 81-0939 (81-0001 not modified by T.O. 1A-10-1087) and subsequent and those modified by T.O. 1A-10-986.
- 5 Aircraft modified by T.O. 1A-10-1084.
- 8 Aircraft prior to serno 75-00280 not modified by T.O. 1A-10-764.
- 10 Aircraft serno 75-00280 and subsequent.
- 11 Aircraft sernos 75-00280 through 77-0226 not modified by T.O. 1A-10-764.
- 16 Aircraft prior to serno 76-0512.
- 19 Aircraft serno 76-0512 and subsequent.

- 23 Aircraft serno 76-0519 and subsequent and those modified by T.O. 1A-10-649.
- 24 Aircraft prior to serno 76-0521 not modified by T.O. 1A-10-649.
- 25 Aircraft serno 76-0521 and subsequent and those modified by T.O. 1A-10-649.
- 28 Aircraft serno 76-0535 and subsequent and those modified by T.O. 1A-10-869.
- 30 Aircraft prior to serno 79-0167 not modified by T.O. 1A-10-932.
- 32 Aircraft prior to serno 77-0177 not modified by T.O. 1A-10-831.
- 33 Aircraft prior to serno 77-0259.
- 35 Aircraft serno 77-0177 and subsequent and those modified by T.O. 1A-10-831.
- 38 Aircraft prior to serno 75-00280.
- 45 Aircraft serno 77-0227 and subsequent and those modified by T.O. 1A-10-764.
- 46 Aircraft sernos 77-0259 through 79-0166.
- 47 Aircraft serno 77-0259 and subsequent.
- 50 Aircraft prior to serno 78-0582.
- 51 Aircraft sernos 78-0582 through 79-0166.
- 53 Aircraft serno 78-0582 and subsequent.
- 54 Aircraft prior to serno 78-0622.

EFFECTIVITY PAGE (CONT)

- 55 Aircraft serno 78-0622 and subsequent.
- 56 Aircraft prior to serno 78-0626.
- 57 Aircraft serno 78-0626 and subsequent.
- 58 Aircraft serno 78-0634 and subsequent and those modified by TO 1A-10-869.
- 61 Aircraft prior to serno 79-0167 not modified by TO 1A-10-975 or TO 1A-10-975D.
- 62 Aircraft serno 79-0167 and subsequent and those modified by TO 1A-10-975 or TO 1A-10-975D.
- 63 Aircraft serno 79-0167 and subsequent and those modified by TO 1A-10-883.
- 64 Aircraft serno 79-0167 and subsequent and those modified by TO 1A-10-932.
- 67 Aircraft serno 80-0178 and subsequent and those modified by TO 1A-10-976.
- 68 Aircraft prior to serno 80-0180.
- 69 Aircraft serno 80-0180 and subsequent.
- 75 Aircraft serno 79-0173 and subsequent.
- 81 Aircraft serno 80-0255 and subsequent and those modified by TO 1A-10-901.
- 82 Aircraft modified by TO 1A-10-1059.
- 83 Aircraft prior to serno 78-0582 not modified by TO 1A-10-1108.
- 84 Aircraft serno 78-0582 and subsequent and those modified by TO 1A-10-1108.
- 91 Aircraft modified by TO 1A-10-1154.
- 94 Aircraft modified by TO 1A-10-1158.
- 96 Aircraft modified by TO 1A-10-1170.
- 97 Aircraft modified by TO 1A-10-1186.
- 98 Aircraft modified by TO 1A-10-1176.
- 99 Aircraft not modified by TO 1A-10-1176.
- 102 Aircraft modified by TO 1A-10-1250.
- 103 Aircraft modified by TO 1A-10-1177.
- 105 Aircraft modified by TO 1A-10-1243.
- 106 Aircraft modified by TO 1A-10-1195.

EFFECTIVITY PAGE (CONT)

- 107 Aircraft modified by TO 1A-10-1228.
- 108 Aircraft modified by TO 1A-10-1216.
- 109 Aircraft modified by TO 1A-10-1267.
- 110 Aircraft modified by AOA indicator Recalibration.

111 *deleted* *15 69*

A-10A

CLOSE AIR SUPPORT ATTACK AIRCRAFT

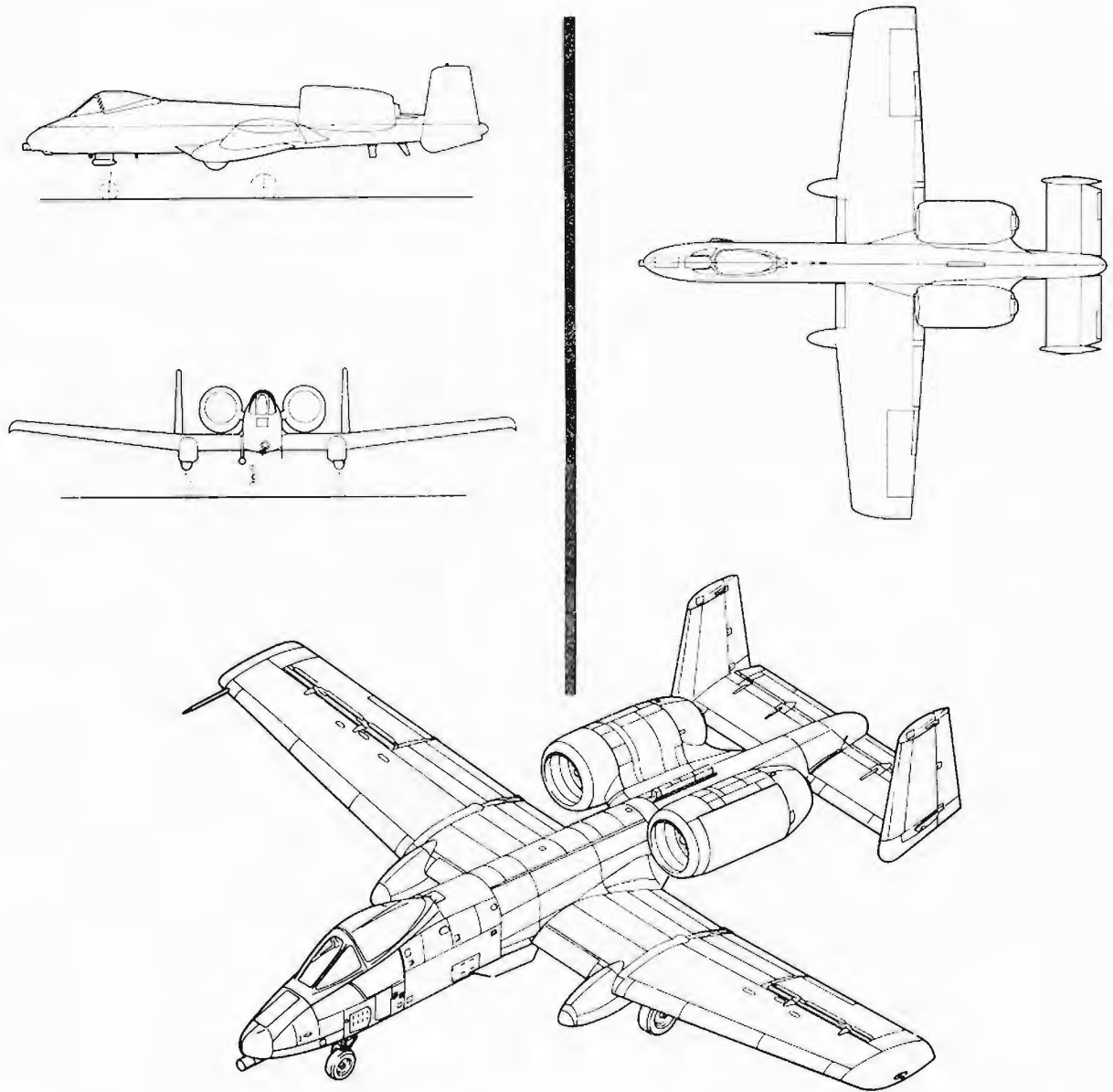

1-10A-1-30

Figure 1-1

SECTION I

DESCRIPTION AND OPERATION

TABLE OF CONTENTS

The Aircraft	1-1	Oxygen System	1-56
Engines	1-3	Environment System	1-58
Fire Extinguishing System	1-11	Flight Instruments	1-67
Auxiliary Power Unit	1-12	Standby Flight Instruments	1-77
Aircraft Fuel System	1-13	Communication/Navigation	1-77
Electrical Power System	1-20	Lighting System	1-141
Hydraulic Power Supply System	1-24	Armament System	1-150
Landing Gear System	1-25	Head-Up Display System	1-152
Nosewheel Steering System	1-28	Gunsight Camera System	1-168
Wheel Brake System	1-28	Cockpit Television Sensor/Airborne	
Primary Flight Control System	1-29	Video Tape Recorder System	1-168
Manual Reversion Flight Control		TV Monitor System	1-168
System	1-40	Target Identification Set Laser	1-168
Secondary Flight Control System	1-43	Chaff/Flare Dispensing System	1-168
Boarding Ladder	1-46	Electronic Countermeasure	
Canopy	1-48	System	1-168
Ejection Seat	1-52	Servicing Diagram	1-171

THE AIRCRAFT

The A-10 is a single-seat close air support aircraft (figures 1-1 and 1-2) manufactured by Fairchild Republic Company, Farmingdale, New York. The aircraft is a low wing, low tail configuration with two high bypass turbo fan engines installed in nacelles mounted on pylons extending from the aft fuselage. Twin vertical stabilizers are mounted on the outboard tips of the horizontal tail. The tricycle forward retracting landing gear is equipped with an anti-skid system and a steerable nosewheel. The nose gear is installed to the right of the aircraft centerline to permit near centerline gunfire. The nose gear retracts fully into the fuselage while the main gears partially retract into streamlined pods in the wings. A titanium armor installation surrounds the cockpit. The primary flight controls are equipped with artificial feel devices to simulate aerodynamic feel. The

elevator and aileron controls split into redundant separate systems before leaving the armor protection. The controls are powered by two independent hydraulic systems, either of which has the capability of controlling the airplane. If both hydraulic systems fail, the airplane can be flown using a manual reversion system. The ailerons consist of an upper and lower panel that become speed brakes when opened. The windshield front panel is resistant to small arms fire and birds. The windshield side panels are resistant to spall spray caused by penetrations. The fuselage fuel cell sumps are self-sealing on the lower portion and tear resistant on the upper portion. The cells are filled with a flexible foam to prevent fuel tank explosion. Single-point ground refueling and engine feed lines are self-sealing. The escape system provides a zero/zero capability (zero velocity, and zero pitch and roll attitude) either with the canopy removed or through the canopy. The

GENERAL ARRANGEMENT DIAGRAM

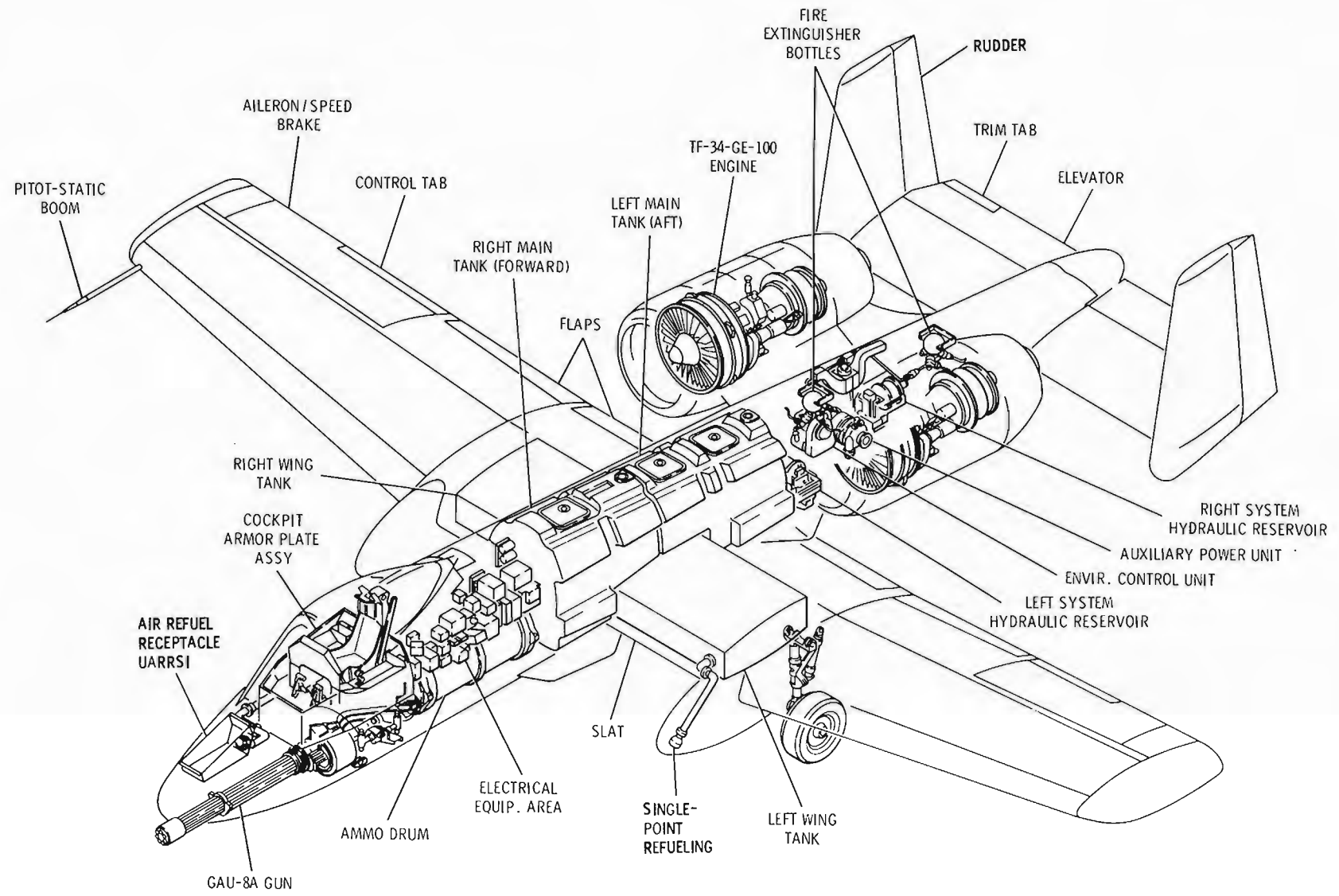

Figure 1-2

1-10A-1-31

armament system includes a high fire rate 30mm seven-barrel gun with ammunition stored in a drum. A variety of stores are carried on 11 pylons, 4 on each wing and 3 on the fuselage.

AIRCRAFT DIMENSIONS

The overall dimensions of the aircraft under normal conditions of gross weight, tire and strut inflation are as follows:

Overall length	53 ft 4 in.
Wing span	57 ft 6 in.
Horizontal tail span	18 ft 10 in.
Height to top of fin	14 ft 8 in.
Wheel base	17 ft 9 in.
Wheel tread	17 ft 3 in.

Refer to Section II for minimum turning radius and ground clearance dimensions.

AIRCRAFT GROSS WEIGHT

The aircraft operating weight is approximately 28,000 pounds. This weight includes pilot, gun (full of ammunition), 11 empty pylons, oil, windshield wash, and unusable fuel. Refer to Section V for gross weight limits. For specific aircraft weight, refer to Weight and Balance Data. T.O. 1-1B-40.

ENGINES

The aircraft is powered by two General Electric TF34-GE-100/91-100A engines (figure 1-3). Sea level, standard day, static thrust for an installed engine is approximately 8,900 pounds at maximum thrust. The engine incorporates a single-stage bypass fan and a 14-stage axial flow compressor. Bypass air produces over 85% of engine thrust. Therefore, engine fan speed is the best indication of thrust. Variable inlet guide vanes automatically modulate throughout the engine operating range. An accessory gearbox drives a hydraulic pump, fuel pump and fuel control, oil pump, and an electric generator. An air bleed for aircraft systems is provided. Engine acceleration time from IDLE to MAX thrust will be approximately 10 seconds at sea level. Engine thrust droop results from differential expansion of the engine turbines and casings during transients from low to high thrust operation. The duration and extent of the thrust droop is dependent upon the rate/range of throttle movement. Thrust droop is decreased if the engines have been idling for a period of time. Thrust droop is further decreased if the engines have been run up before takeoff. An example of the worst

condition would be a scramble takeoff where takeoff is accomplished shortly after engine start. Maximum droop occurs approximately 10 seconds after the throttle is advanced from IDLE to MAX. After approximately 4 minutes of operation at MAX thrust, power output returns to normal. Elimination of thrust droop can be observed on the engine fan speed indicator. Thrust will increase as fan speed increases.

94 TURBINE ENGINE MONITORING SYSTEM (TEMS)

The turbine engine monitoring system (TEMS) provides a means for supporting the on-condition maintenance concept for the TF34-100A engine installed on the A-10A aircraft. Information is provided to the system electronic processor unit (EPU) automatically whenever the engine is operated. If any engine operation limit is exceeded, or when the TEMS DATA switch is pressed, a frame of data is recorded. An overlimits event will be displayed on the umbilical display unit (UDU), located in the nosewheel well. This data is provided in code form for the technician or pilot to determine engine condition. The codes are provided in figure 2-9.

ENGINE OIL SYSTEM

The engine oil system is self-contained and all the oil supplied is used for lubrication and cooling. Usable oil capacity is 5.6 quarts, and maximum oil consumption is 0.5 pints/hr. An oil pressure indicator and an independent light on the caution light panel monitor oil pressure of each engine. Oil grade and specification to be used are covered in the servicing diagram, figure 1-71.

Engine Oil Pressure Indicators

An oil pressure indicator (41, figure FO-1) is provided for each engine. They indicate oil pressure in psi, and are powered by the 26 V instrument transformer bus.

Engine Oil Pressure Caution Lights

An engine oil pressure caution light (independent of the oil pressure indicators) (figure 1-65), on the caution light panel, is provided for each engine. The lights are placarded L-ENG OIL PRESS and R-ENG OIL PRESS and will come on if the pressure is less than 27.5 (± 2.5) psi. *Added ser 18-69*

ENGINE FUEL SYSTEM

The engine fuel system (figure FO-4) provides fuel required for combustion, controls engine variable geometry actuation, and provides engine oil cooling. Fuel is supplied to the engine fuel pumps, where it is pressurized and directed to the fuel control. From the fuel control, metered fuel passes through the engine oil cooler to the distribution valve.

TF-34 ENGINE

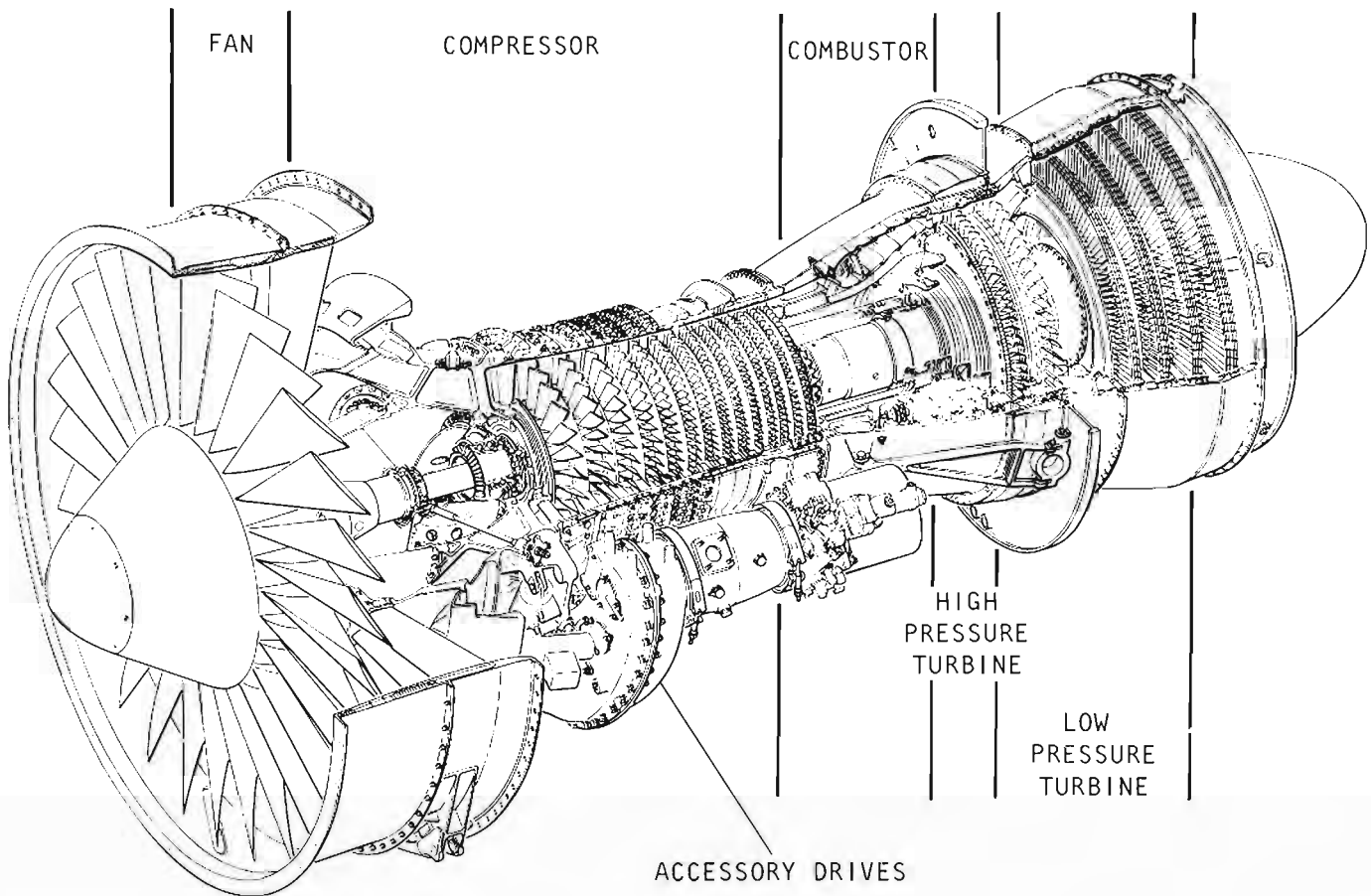

1-10A-1-32

Figure 1-3

ENGINE FUEL CONTROL

The engine fuel control (figure FO-4) is a hydro-mechanical type which modulates fuel flow to maintain a constant core speed as called for by throttle position. An electrical control unit regulates fuel flow at maximum power to maintain ITT limits. In the event of an ITT control unit electrical failure, the system can be disabled with the engine fuel flow switch. In this mode, the engine will be speed-controlled throughout the entire range of operation, requiring pilot monitoring to prevent engine overtemperature.

The fuel control also prevents compressor discharge pressure from exceeding structural limits of the compressor. At sea level static, this limit is normally encountered at maximum power when engine inlet temperature is 0°F or colder. The limit can also be encountered on a standard day at sea level above approximately 330 knots. In this case it will not be possible to obtain rated ITT. The fuel control automatically controls the position of the compressor inlet guide vanes and the first five stator stages to prevent compressor stall. The engine fuel control does not require electrical power, but the ITT control unit is powered by the auxiliary AC essential bus.

Engine Fuel Flow Indicators

A fuel flow indicator (43, figure FO-1) is provided for each engine. They show fuel flow in pounds per hour. The indicators are powered by the right AC bus.

Engine Fuel Flow Switches

Two engine fuel flow switches (figure 1-4), one for each engine, are located on the engine control panel. These switches are placarded ENG FUEL FLOW L and R and each switch has two positions, placarded NORM and OVERRIDE. With the switch in NORM, the engine fuel flow is scheduled on the basis of throttle position and limited to the maximum power trim setting by the ITT amplifier. In the event of an ITT amplifier failure, the temperature control system can be deactivated by placing the appropriate switch in OVERRIDE. When this is done, the engine will be speed controlled by the throttle position alone. Selection of OVERRIDE when ITT is below the maximum power trim setting will produce no change in engine operation. The engine fuel flow switches are powered by the auxiliary AC essential bus.

THROTTLES

A mechanical throttle (figure 1-4) controls the operation of each engine. Each throttle has three positive stop positions placarded OFF, IDLE, and MAX. To move from OFF to IDLE the throttle is raised and moved forward to the first stop position. To move to OFF the throttle is retarded to the IDLE stop, then raised and moved aft to OFF. The DC fuel pump is energized when either throttle is positioned to IDLE or above, and there is no pressure from the left main tank boost pump. On [8] and [45], when the throttle is at IDLE stop, the following actions take place provided engine core rpm is below 56%, and electrical power and an air source are available.

- ATS valve opens causing the ENG START CYCLE light to come on
- ECS shutoff valve closes
- Both engine bleed air shutoff valves open
- Ignition is supplied to the engine
- Fuel is supplied when engine rotation starts.

Engine speed is normally controlled by the throttle. Under certain flight conditions, the engine fuel control overrides the throttle to protect the engine from overtemperature, overpressure, and compressor stall.

Switches and controls located on the throttle are as shown on figure 1-4.

Throttle Friction Control

Throttle friction for both throttles is controlled by means of the friction control located on the throttle quadrant (figure 1-4).

ENGINE IGNITION SYSTEM

Ignition is supplied by two ignitors in each engine. The ignition ignitors are powered by the AC essential bus and actuated by DC powered relays. The ignitor circuits are protected by two ENG IGNITOR (L/R-1 and L/R-2) circuit breakers. Each circuit breaker protects an ignition circuit in each engine; therefore, to totally disable the ignition circuit to one engine, it is necessary to open both circuit breakers.

Engine Ignition Controls

The ignition system is pilot-actuated through throttle position (IDLE, core rpm below 56%) [8] [45], the ignition button [8] [11], or by the IGN function of the engine operate switch [45] (figures 1-4 and 1-5). On [3], ignition is provided to both engines while the gun trigger is depressed to the second detent and for 30 seconds after gun trigger release. On [4], ignition is provided to both engines while the gun trigger is depressed to the second detent or during activation of stall warning chopped tone, and continues for 1 second after gun trigger release or termination of stall warning.

BLEED AIR SYSTEM

Bleed air from each engine, from the APU, and from a ground receptacle are routed to a common manifold (figure 1-7). The bleed air supply system furnishes air for the following:

- Engine starter system
- Environment control system
- Windshield rain removal and wash system
- Canopy de-fog system

THROTTLE QUADRANT INCLUDING ENGINE CONTROL PANEL

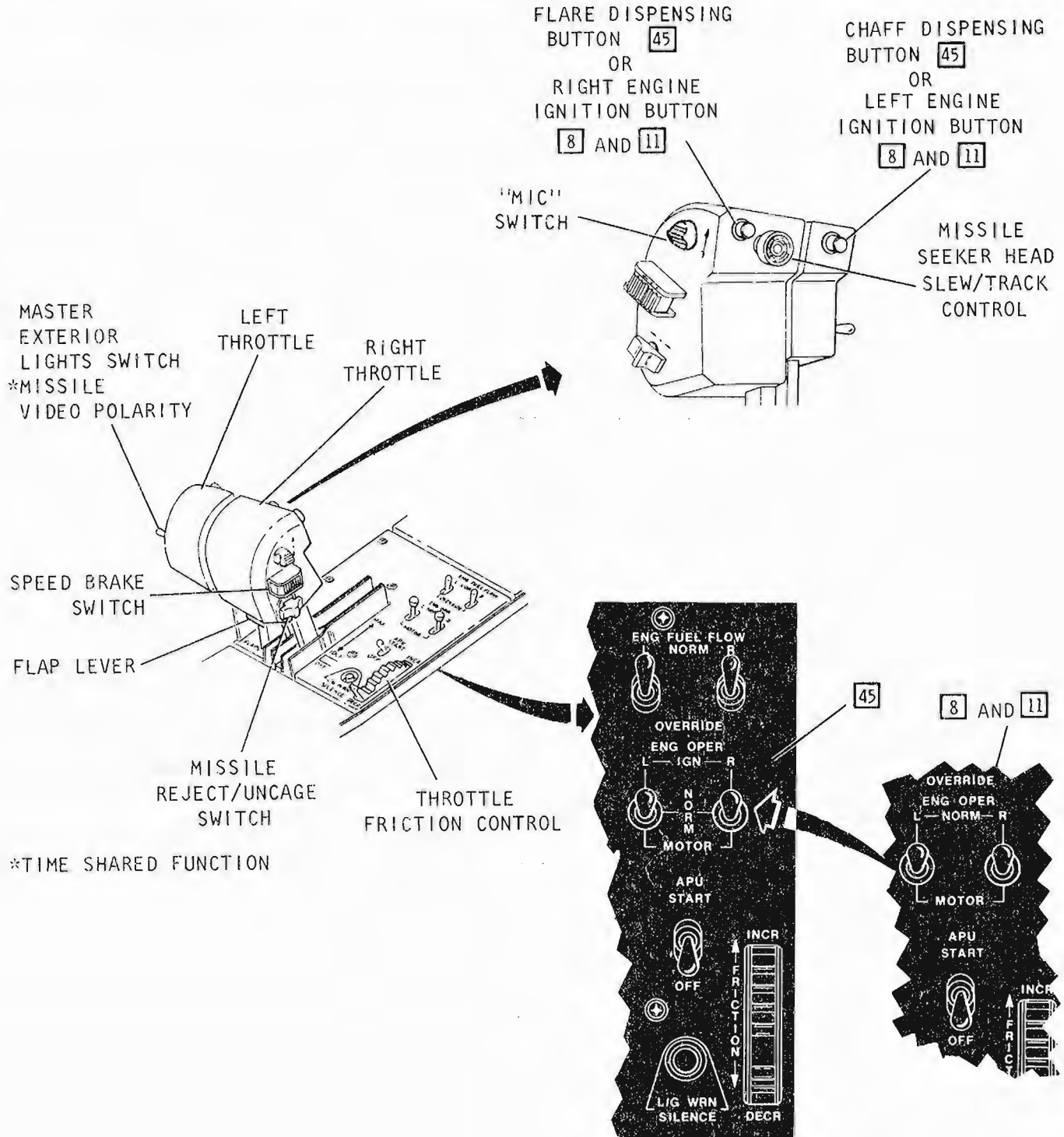

1-10A-1-3

Figure 1-4

ENGINE IGNITION SYSTEM DIFFERENCES

IGNITION PROVIDED TO ENGINES	OLD AUTO START 8	MANUAL START 11	NEW AUTO START 45
BY THROTTLE POSITION	THROTTLE IN IDLE IF ENGINE CORE RPM IS BELOW 56%	IGNITION NOT PROVIDED	THROTTLE IN IDLE IF ENGINE CORE RPM IS BELOW 56%
BY BUTTONS ON THROTTLE	PROVIDED WHEN BUTTONS ARE PRESSED AND FOR 30 SEC. AFTER BUTTONS ARE RELEASED, REGARDLESS OF THROTTLE POSITION, RPM OR ENGINE OPERATE SWITCH POSITION.		IGNITION NOT PROVIDED. THESE BUTTONS ARE USED FOR CHAFF/FLARE DISPENSING.
BY ENGINE OPERATE SWITCH	IGNITION NOT PROVIDED		PROVIDED WHEN ENGINE OPERATE SWITCH IS PLACED IN IGN AND FOR 30 SEC. AFTER SWITCH IS RELEASED, REGARDLESS OF THROTTLE POSITION OR RPM

Figure 1-5

- Canopy seal
- Anti-g suit
- External tank pressurization.

Each of the above systems is described in detail under the respective sections. Bleed air supplied from the engine is controlled by a shutoff valve adjacent to each engine. Both valves are opened or closed simultaneously by the bleed air switch. Bleed air from the APU and/or external source is not controlled by the bleed air switch.

A temperature sensor is provided adjacent to the manifold for bleed air leak detection. The bleed air leak detection system is powered by the auxiliary AC essential bus.

Bleed Air Switch

The bleed air switch (figure 1-30), on the environmental panel, is a two-position lever-locked switch, with positions placarded BLEED AIR and OFF. BLEED AIR opens both engine bleed air valves and will provide bleed air to any bleed air system selected by appropriate controls. OFF closes the valves except during engine start. The switch is powered by the DC essential bus.

Fire Detect/Bleed Air Leak Test Button

The fire detect/bleed air leak test button (figure 1-65) is a push-to-test button, placarded FIRE DETECT BLEED AIR LEAK TEST. Depressing the switch checks the bleed air sensors, fire detection sensors, and associated warning lights. If the circuit is intact, BLEED AIR LEAK caution light on the caution light panel and the MASTER CAUTION, FIRE (L ENG) PULL, FIRE (R ENG) PULL, FIRE (APU) PULL lights will come on. The test button is powered by the auxiliary DC essential bus.

Bleed Air Leak Caution Light

The bleed air lines upstream from the precooler are monitored by a leak detection system. Upon sensing a temperature of 400 °F or more, the system responds by activating the BLEED AIR LEAK caution light on the caution light panel (figure 1-65).

ENGINE OPERATE SWITCHES 8

Two engine operate switches (figure 1-4), one for each engine, are located on the engine control panel. These lever-locked switches are placarded ENG OPER L and R, with each switch having two positions placarded NORM and MOTOR. NORM is used during normal engine operation and for engine

starting. MOTOR is used for air-purging of excessive fuel, cooling the engine, or manual starting. When the switch is moved to MOTOR, the following actions are accomplished, provided electrical power and an air source are available:

- ATS valve opens causing the ENG START CYCLE light to come on
- ECS shutoff valve closes
- Both engine bleed air shutoff valves open.

NOTE

- The throttle must be in OFF or IDLE in order to motor the engine.

The engine operate switches are powered by the DC essential bus.

ENGINE OPERATE SWITCHES 11

Two engine operate switches (figure 1-4), one for each engine, are located on the engine control panel. These lever-locked switches are placarded ENG OPER L and R, with each switch having two positions placarded NORM and MOTOR. NORM is used during normal engine operation. MOTOR is used for engine starts, air-purging of excessive fuel, and cooling the engine. When the switch is moved to MOTOR, the following actions are accomplished, provided electrical power and an air source are available:

- ATS valve opens causing the ENG START CYCLE light to come on
- ECS shutoff valve closes
- Both engine bleed air shutoff valves open.

NOTE

- The throttle must be in OFF or IDLE in order to motor the engine.

The engine operate switches are powered by the DC essential bus.

ENGINE OPERATE SWITCHES 45

Two engine operate switches (figure 1-4), one for each engine, are located on the engine control panel. These switches are placarded ENG OPER L and R, with each switch having three positions placarded IGN, NORM, and MOTOR. The switches are spring-loaded from IGN to NORM positions. The switches must be raised when moving between NORM and MOTOR. Momentarily placing the engine operate switch to IGN will supply ignition to the corresponding engine for 30 seconds, regardless of the throttle position or engine core rpm. NORM is used during normal engine operation and for engine starting. MOTOR is used for air-purging of excessive fuel, cooling the engine, or manual starting. When the switch is moved to MOTOR, the following actions are accomplished, provided electrical power and an air source are available:

- ATS valve opens causing the ENG START CYCLE light to come on
- ECS shutoff valve closes
- Both engine bleed air shutoff valves open.

NOTE

- The throttle must be in OFF or IDLE in order to motor the engine.

The engine operate switches are powered by the DC essential bus.

ENGINE START SYSTEM

Engine starts require low pressure air to power the ATS unit mounted on the engine. Air may be obtained from the following sources:

- APU
- Crossbleed air from an operating engine (85% core rpm minimum)
- External pneumatic power unit.

Air from any of these sources (figure 1-7) is ducted through the bleed air shutoff valves to the ATS valves. The throttle must be in IDLE to obtain starter-assisted engine starts. If the throttle is moved above IDLE, the bleed air to the starter will be shut off. The electrical circuits controlling the two ATS valves are interlocked to prevent both valves being opened simultaneously. Insufficient air pressure is available to start both engines simultaneously. After the start is complete, the ATS valve is closed (automatically or manually) to prevent overspeeding of the ATS and the ENG START CYCLE light goes off. During the start, the ECS is shut off automatically to eliminate bleed air drain during the start cycle. Electrical power for starting the engines may be obtained from an external AC power unit, aircraft battery and inverter, or APU generator.

There are three different start systems, depending on block aircraft (figure 1-6).

8 aircraft contain an automatic engine starting system. Automatic engine starting will be initiated

when the throttle is moved to IDLE, provided the engine core rpm is below 56%, electrical power and an air source are available. The following events occur:

- ATS valve opens, allowing engine to rotate
- ECS shutoff valve closes
- Both engine bleed air shutoff valves open
- Ignition is supplied for a minimum of 30 seconds
- Fuel is provided after engine starts to rotate
- ATS valve closes after engine reaches 56% core rpm
- ECS valve opens after engine reaches 56% core rpm
- Both engine bleed air shutoff valves close after engine reaches 56% core rpm.

ENGINE START SYSTEM DIFFERENCES

OPEN ATS VALVE	OLD AUTO START 8	MANUAL START 11	NEW AUTO START 45
1. BY ENGINE OPERATE SWITCH	POSITION TO MOTOR (THROTTLE IN OFF).	POSITION TO MOTOR (THROTTLE IN IDLE OR OFF). (THIS IS THE NORMAL START METHOD.)	POSITION TO MOTOR (THROTTLE IN OFF).
2. BY THROTTLE	THROTTLE TO IDLE (REGARDLESS OF ENG OPERATE SWITCH POSITION). (THIS IS THE NORMAL START METHOD.)	ATS VALVE CANNOT BE OPENED BY THROTTLE IF ENGINE OPERATE SWITCH IS IN NORM.	SAME AS OLD AUTO START.
START FUEL FLOW/ SCHEDULING.	THROTTLE TO IDLE (REGARDLESS OF ENGINE OPERATE SWITCH POSITION) WITH ENGINE ROTATION.		
SHUT ATS VALVE			
1. BY ENGINE OPERATE SWITCH	RETURN TO NORM (THROTTLE IN OFF).	RETURN TO NORM. (THIS IS THE NORMAL START METHOD.)	PLACE SWITCH OUT OF MOTOR POSITION (THROTTLE IN OFF).
2. BY THROTTLE	THROTTLE TO OFF (ENG OPERATE SWITCH IN NORM).	THROTTLE TO OFF HAS NO EFFECT ON ATS VALVE.	SAME AS OLD AUTO START.
	THROTTLE ABOVE IDLE (REGARDLESS OF ENG OPERATE SWITCH POSITION).		
3. AUTOMATICALLY	AT 56% CORE RPM.	NO AUTO SHUTOFF.	10 SECONDS AFTER 56% CORE RPM.

Figure 1-6

ENGINE START SYSTEM

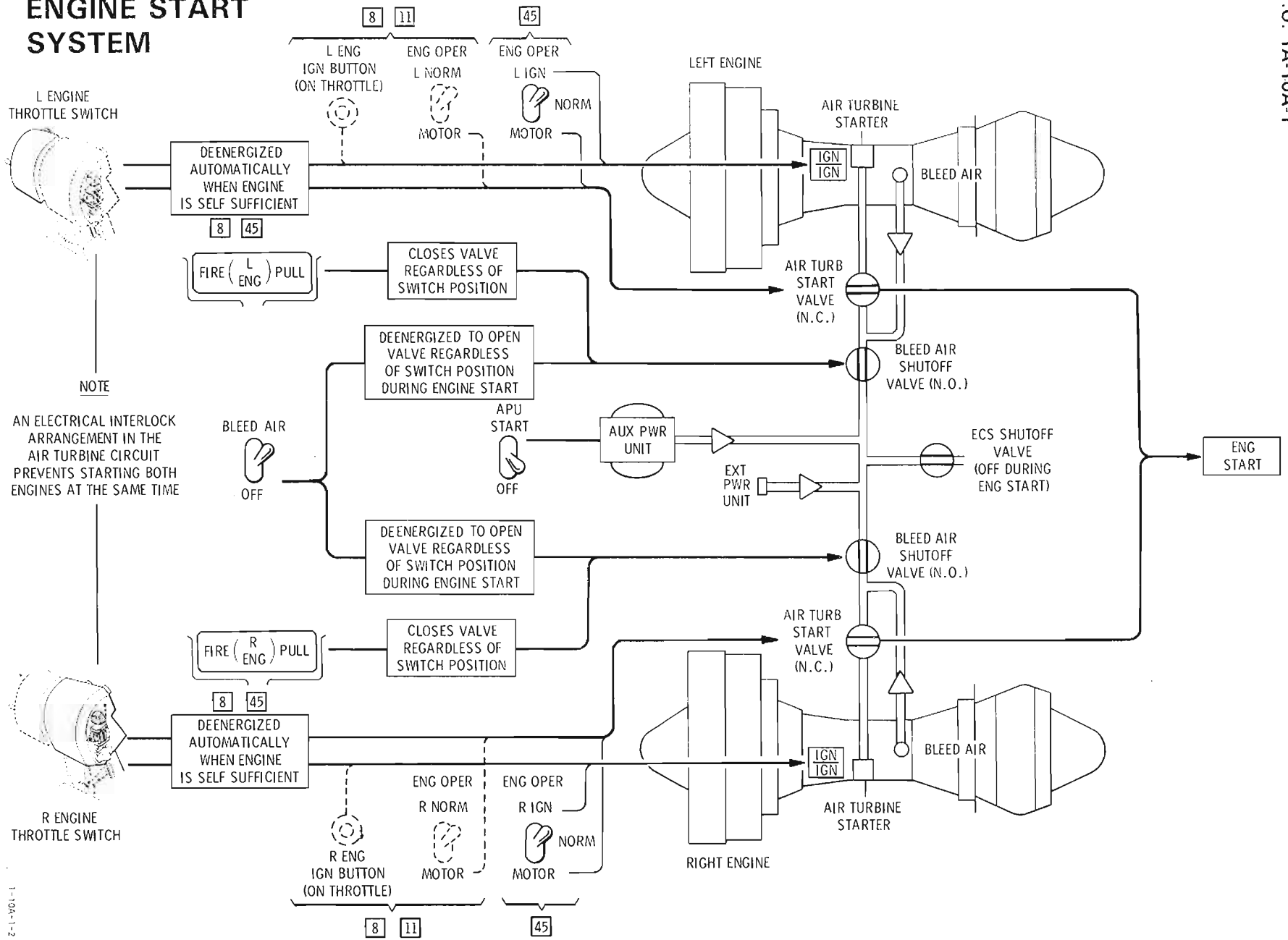

Figure 1-7

1-10A-1-2

11 aircraft contain a manual starting system. This requires that the engine operate switch be positioned to MOTOR, ignition button depressed, and throttle in IDLE.

45 aircraft contain an automatic engine starting system. Automatic engine starting will be initiated when the throttle is moved to IDLE, provided the engine core rpm is below 56%, electrical power and an air source are available. The following events occur:

- ATS valve opens, allowing engine to rotate
- ECS shutoff valve closes
- Both engine bleed air shutoff valves open
- Ignition is supplied for a minimum of 30 seconds
- Fuel is provided after engine starts to rotate
- ATS valve closes 10 seconds after engine reaches 56% core rpm
- ECS valve opens 10 seconds after engine reaches 56% core rpm
- Both engine bleed air shutoff valves close 10 seconds after engine reaches 56% core rpm.

Engine Start Cycle Caution Light

The engine start cycle caution light (figure 1-65), on the caution light panel, is placarded ENG START CYCLE and will come on whenever the ATS valve is opened.

Engine Core Speed Indicators

An engine core speed indicator (40, figure FO-1) is provided for each engine. The indicators display the speed of the compressor core in percent rpm. The system is independent of the aircraft electrical system except for instrument lighting purposes.

Engine Fan Speed Indicators

A fan speed indicator (42, figure FO-1) is provided for each engine. The indicators display the fan speed in percent rpm and are powered by the auxiliary AC essential bus.

Engine Interstage Turbine Temperature Indicators

An ITT indicator (39, figure FO-1) is provided for each engine. The indicators display the temperature between the high and low pressure turbine sections in degrees C. A warning flag placarded OFF will appear in a window to indicate power loss. The indicators are powered by the auxiliary AC essential bus.

Engine Overheat Caution Lights

An engine overheat caution light (figure 1-65), on the caution light panel, is provided for each engine. The lights are placarded L ENG HOT and R ENG HOT and will come on if the ITT indicator exceeds 835°C/91 880°C.

FIRE EXTINGUISHING SYSTEM

The fire extinguishing system is available to both engines and to the APU compartment/area. It consists of fire extinguishing agent stored in two independently actuated pressurized bottles located in the fuselage. Either bottle may be discharged to either engine nacelle or the APU compartment/area by pulling the appropriate fire handle and actuating the discharge switch. The system is dearmed by pushing the appropriate fire handle in. The fire extinguishing system operates on battery bus power. However, fire detection and fuel/bleed air shutoff functions require auxiliary DC essential and DC essential bus power.

NOTE

- Extinguishing agent will not put out an engine core fire as it does not discharge into the core. Extinguishing agent should be used if the fire light comes on, indicating fire in the engine nacelle.

FIRE DETECTION SYSTEM

Fire detection is provided for in both engine nacelles, and in the APU area by continuous temperature-sensitive elements. The fire warning light in the applicable left or right engine fire handle will come on when the entire sensor element is heated to approximately 650°F. The APU fire and overheat system is similar to the engine fire system except that the warning light is in the APU fire handle. The APU fire detection includes coverage for the adjacent hydraulic, fuel,

electrical, flight control and environmental control subsystems equipment installed in the fuselage between the fuel tank aft bulkhead and the frame aft of the APU. Both systems are powered by the auxiliary DC essential bus. The system is tested by depressing the FIRE DETECT BLEED AIR LEAK TEST button. Refer to Bleed Air System for test function description.

CAUTION

- The fire detection system may not detect an engine nacelle or APU compartment fire/overheat condition of high intensity and short duration.

ENGINE AND APU FIRE HANDLES

Three T-shaped handles (8, 9, 10, figure FO-1), located in the glareshield on the instrument panel, provide fire warning for the engine nacelles or the APU when illuminated. The handles are labeled FIRE (L ENG) PULL, FIRE (APU) PULL, and FIRE (R ENG) PULL. The lights are powered by the auxiliary DC essential bus. By pulling the appropriate fire handle the pilot initiates the following actions:

Engine Fire

- Arms the fire extinguishing system to respective engine nacelle (provided battery bus power is available)
- Cuts off fuel flow to the affected engine by closing the motorized main fuel shutoff valve (provided DC essential bus power is available)
- Closes the bleed air shutoff valve from the affected engine (provided DC essential bus power is available).

APU Fire

- Arms fire extinguishing system to APU compartment (provided battery bus power is available).
- Cuts off fuel flow to the APU fuel control by closing the solenoid operated APU fuel shutoff valve (provided DC essential bus power is available).

CAUTION

- With more than one fire handle pulled, the fire extinguishing agent will be discharged into all areas selected. The quantity then discharged into the areas selected may be insufficient to extinguish that fire.

Fire Extinguishing Agent Discharge Switch

The fire extinguishing agent discharge switch (11, figure FO-1), placarded FIRE EXTING DISCH, is located on the right side of the glareshield above the instrument panel. The switch has three unlabeled positions. When the switch is moved either left or right, an extinguisher bottle is discharged and agent is directed to the engine or APU compartment selected by the fire handle. The switch will remain in the selected position to indicate which extinguisher bottle was discharged. The fire extinguisher bottles can be armed and discharged if battery bus power is available.

AUXILIARY POWER UNIT

The APU (figure 1-2) supplies air for engine starting, drives a generator for aircraft electrical power, and can drive a hydraulic pump to pressurize the aircraft hydraulic system for ground maintenance functions. The unit is located in the aft fuselage between the two engines and is provided with safety devices that shut down the APU when certain operating limitations are exceeded. Fuel for APU starting is supplied by the DC fuel pump. APU controls are powered by the DC essential bus.

APU SWITCH

The APU switch (figure 1-4) is a two-position switch, placarded START and OFF. START supplies DC essential bus power to operate the DC fuel pump, open the APU fuel valve, enable APU compartment cooling, energize the APU starter, and enable the APU EGT gauge and APU tachometer.

APU GENERATOR SWITCH

The APU generator switch (figure 1-11), placarded APU GEN, is a two-position lever-lock switch, placarded PWR and OFF/RESET. When in PWR, the APU generator powers an APU hydraulic pump cooling fan and electrical system busses, provided the busses are not powered by an engine generator or external power. If the APU generator drops off the line, the system may be reset by momentarily placing the APU generator switch in OFF/RESET and returning it to PWR.

APU GENERATOR CAUTION LIGHT

The APU generator caution light (figure 1-65) is placarded APU GEN. The light is inoperative when the APU generator switch is in OFF/RESET.

With the APU generator switch in PWR,

Light on indicates:

- Inoperable generator
- APU operating with generator switch in PWR but aircraft busses being powered by either external power or engine generator(s)



- During this mode of operation the caution light is on regardless of APU generator output. There is no indication that the APU hydraulic pump cooling fan is not receiving power. Overheating of the pump could result from extended operation with a failed APU generator either in the air or on the ground.
- APU not running and generator switch in PWR.

NOTE

- If the APU is operating with the APU generator switch in PWR, and APU is shut down and restarted, the APU generator will remain inoperative until the APU generator switch is momentarily positioned to OFF/RESET, then returned to PWR.

Light off indicates:

- APU powering aircraft busses.

APU TACHOMETER

The APU tachometer (44, figure FO-1) indicates the speed of the APU in percent rpm. DC essential bus power is required to enable the APU tachometer through the APU switch.

APU TEMPERATURE INDICATOR

The APU temperature indicator (45, figure FO-1) indicates the turbine discharge temperature in degrees C. The indicator is powered by the DC essential bus and is enabled by the APU switch.

APU OPERATION

APU starting requires only DC essential bus power and a fuel supply. When the APU start switch is positioned to START, the DC essential bus power operates the DC fuel pump, opens the APU fuel valve (aft fuel tank mounted), and energizes the APU starter. The starter rotates the APU compressor and, at approximately 10% rpm, the APU fuel valve (APU mounted) opens and fuel and ignition are supplied to the APU. Acceleration of the APU continues until at approximately 60% rpm the starter disengages. At approximately 95% rpm, ignition is terminated and the APU is self-sustaining. APU speed and turbine discharge temperature are automatically controlled. The APU will stabilize at 100(±3)% rpm in approximately 60 seconds. APU starts can be made up to an altitude of 15,000 feet (most cases up to 20,000 feet) and the APU output will be sufficient to start an engine up to an altitude of 10,000 feet (most cases up to 15,000 feet). The APU will operate during negative g conditions for approximately 10 seconds.

On [28], APU will automatically shutdown during ground operation if the APU EGT is excessive, APU rpm is excessive, APU oil pressure is low, or the APU fire warning system is activated. On [58], APU overtemperature shutdown is disabled during ground engine start cycle plus 4 seconds. Once the weight is off the landing gear, the APU will automatically shutdown only if the rpm is excessive or the oil pressure is low.

AIRCRAFT FUEL SYSTEM

The aircraft fuel supply system (figure FO-4) consists of two internal wing tanks (left and right wing), and two tandem-mounted fuselage tanks (left main-aft and right main-forward). Up to three external (pylon) tanks may be carried; one tank on each wing and one on the fuselage centerline. The fuel supply system

operates as two independent subsystems, with the left wing and left main tank feeding the left engine and the APU, and the right wing and right main tank feeding the right engine. The two subsystems can be interconnected by opening crossfeed valves (controlled by a single switch in the cockpit) to allow pressurized fuel flow to both engines and the APU from either subsystem. In addition, the two main tanks can be interconnected by opening a tank gate valve. The main tank sumps are self-sealing bladder cells. Each self-sealing sump contains approximately 900 pounds of fuel. The upper portion of the cells are tear-resistant bladders. The wing tanks are integral within the wing structure and do not have bladder cells. Foam is incorporated in each tank to prevent fuel tank explosion. Boost pressure is provided by boost pumps located in each main and wing tank. A DC boost pump, located in the left main tank is used during engine and APU starts if the left main boost pump is inoperative. For negative g flight, collector tanks will supply the engine with sufficient fuel for 10 seconds operation at MAX power. In the event of a main tank boost pump failure, the affected engine will suction-feed from the failed tank for all power settings up to an altitude of 10,000 feet (most cases up to 20,000 feet). The wing tank boost pumps operate at a higher pressure and override the main tank boost pumps to automatically empty the wing tanks first.

The main fuel feed lines to each engine, and to the APU, contain shutoff valves that are controlled by the fire handles. These shutoff valves allow for isolation of the fuel feed system outside the tanks.

Fuel in the external tanks is transferred to the main or wing tanks by pressure from the bleed air system. Fuel tank sump drains are provided for each tank. Drain valves can be opened externally. Fuel cavity drains are provided in each main tank, and protrude through the aircraft skin to give an indication of fuel cell leaks.

The wing tanks have a dual-level refueling shutoff valve. The valve closes when the tank is full and will not reopen unless the fuel level drops approximately 400 pounds or a time delay of approximately 10 minutes has elapsed. Wing tanks cannot be topped off unless the fuel level is below approximately 1,590 pounds or the fuel manifold has been unpressurized for the time delay period. This assures even fuel transfer from the external tanks. Therefore, during fuel transfer from the external tanks, the wing tank

fuel quantity will drop approximately 400 pounds, then will fill to capacity. This cycling repeats until external fuel is depleted. During air refueling the wing tanks will not accept fuel unless the fuel level in the tanks has dropped approximately 400 pounds or the time delay has elapsed. The total fuel on board after refueling could be approximately 800 pounds less than total capacity. If total fuel capacity is required during air refueling, the external tanks can be turned off sufficiently prior to refueling so that the wing tank quantity drops approximately 400 pounds or the time delay has elapsed.

A single-point ground refueling receptacle, located in the leading edge of the left landing gear nacelle, permits refueling of each internal and external tank. A control panel, adjacent to the refueling receptacle, provides a means of ground checking the refueling valve shutoff. The panel also permits selective loading of any internal or external tank. Auxiliary DC essential bus power is required for refueling valve checks, selective tank filling, and to enable external tank filling. When the tanks are full the refueling valves are closed by a float valve in each tank. Fuel tank capacities are shown in the usable fuel quantity data table, figure 1-8. Fuel grade and specification to be used are covered in the servicing diagram, figure 1-71.

In addition to features previously mentioned, the following survivability features are built into the fuel system:

- Single-point ground refueling and engine feed lines outside the tanks are self-sealing to prevent leaks
- The fuel feed shutoff valves are inside the tanks to keep the engine feed lines dry after shutoff
- Fill disable switches are provided to close off a damaged internal tank when air refueling.

FUEL QUANTITY INDICATOR AND SELECTOR

The fuel quantity indicator (figure 1-9) is provided to monitor the total fuel remaining, or fuel remaining in selected tanks. The digital readout is a continuous display of total fuel remaining including external, in pounds. The pointer display provides an indication of fuel in specific tanks as selected by the rotary selector switch. The left and right pointers indicate for the left and right fuel systems, respectively. The fuel

USABLE FUEL QUANTITY DATA

FUEL TANK	GALLONS	POUNDS		
		JP-4 (NOTE 1)	JP-5 (NOTE 2)	JP-8 (NOTE 3)
L. MAIN	511	3,270	3,475	3,424
R. MAIN	511	3,270	3,475	3,424
L. WING	311	1,990	2,115	2,084
R. WING	311	1,990	2,115	2,084
TOTAL INTERNAL	1,644	10,520	11,180	11,016
CENTERLINE	600	3,840	4,080	4,020
L. WING	600	3,840	4,080	4,020
R. WING	600	3,840	4,080	4,020
TOTAL EXTERNAL	1,800	11,520	12,240	12,060
TOTAL FUEL	3,444	22,040	23,420	23,076

NOTES:

- FUEL WEIGHT BASED ON 6.4 LBS PER GALLON.
- FUEL WEIGHT BASED ON 6.8 LBS PER GALLON.
- FUEL WEIGHT BASED ON 6.7 LBS PER GALLON.

FUEL QUANTITIES BASED ON FUEL TEMPERATURE OF 60 (± 40)°F (TO 42B1-1-14).

Figure 1-8

quantity indicator is powered by the auxiliary AC essential bus. Positions of the selector are as follows:

- INT — Left and right pointers indicate total internal fuel for respective system
- MAIN — Left and right pointers indicate fuel in the respective main tank
- WING — Left and right pointers indicate fuel in the respective wing tank
- EXT WING — Left and right pointers indicate fuel in the respective wing pylon tank
- EXT CTR — Left pointer indicates fuel in the fuselage pylon tank. The right pointer will zero

- TEST IND — When button is depressed the left and right pointers will read 3,000 (± 300) pounds each and the digital readout will read 6,000 (± 400) pounds. When the TEST IND switch is released the pointers and digital readout will return to the normal positions.

NOTE

- The fuel quantity totalizer will read high if the left main tank quantity is below approximately 500 pounds and a considerable quantity of the fuel remains in the other tanks. The percent error will decrease as the fuel remaining decreases. However, the individual tank readings obtained by utilizing the fuel quantity selector are not affected.

FUEL QUANTITY INDICATOR AND SELECTOR

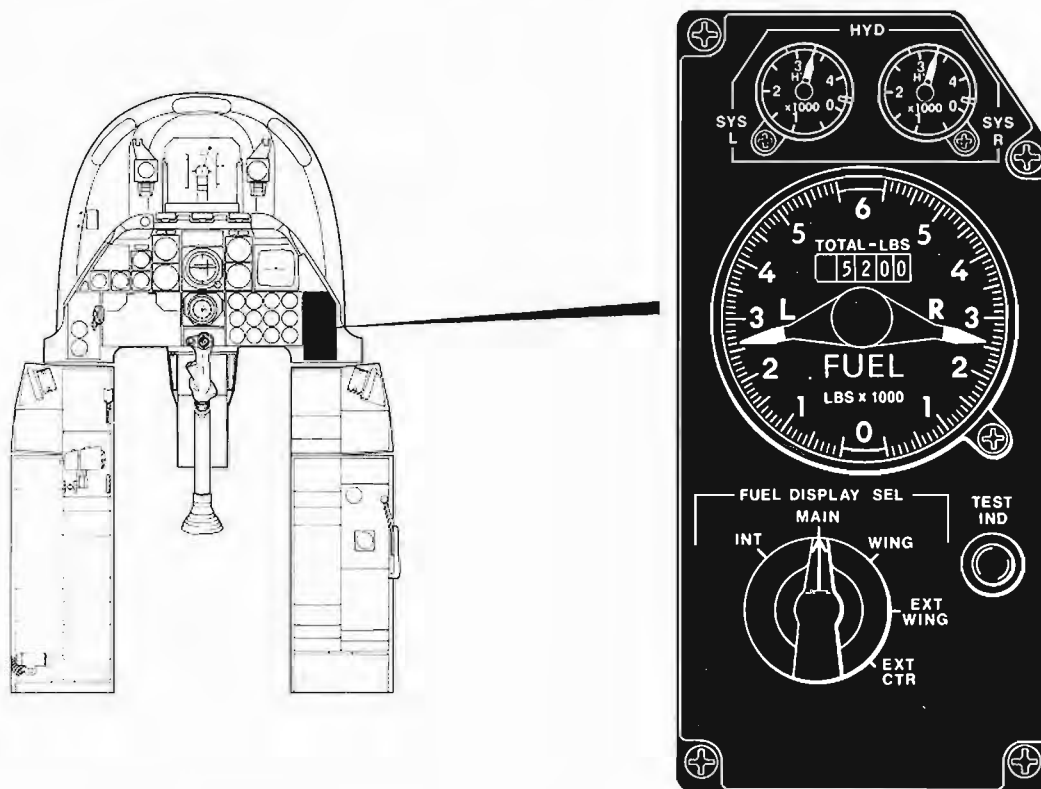

1-10A-1-33

Figure 1-9

LEFT AND RIGHT MAIN FUEL LOW CAUTION LIGHTS

The left and right main fuel low caution lights (figure 1-65) are placarded L-MAIN FUEL LOW and R-MAIN FUEL LOW, respectively. When the L-MAIN FUEL LOW caution light comes on, fuel quantity in the left main fuel tank is 650 (+150, -100) pounds. When the R-MAIN FUEL LOW caution light comes on, quantity in the right main fuel tank is 500 (+150, -100) pounds. This condition can be verified at the fuel quantity indicator. The lights operate independently of the gauge.

LEFT AND RIGHT FUEL PRESSURE CAUTION LIGHTS

The left and right fuel pressure caution lights (figure 1-65), placarded L-FUEL PRESS and

R-FUEL PRESS, respectively, come on to indicate low fuel pressure at the engine fuel feed lines.

FUEL TANK VENT SYSTEM

Each main and wing tank (figure FO-4) is vented independently to a vent collector tank located in the left main tank. Vent lines from the wing tanks also serve as return lines for any fuel collected in the vent tank. Fuel in the vent tank is vented to the wing tanks or overboard.

Foam is installed in the vent tank to provide fire and lightning protection for the fuel system.

MAIN TANK BOOST PUMP SWITCHES

Two main tank boost pump switches (figure 1-10) are placarded **BOOST PUMPS**, with positions **L-MAIN-R** and **OFF**. L and R supply left and right AC bus power to the respective main boost pump. **OFF** deactivates the respective boost pump.

LEFT AND RIGHT MAIN BOOST PUMP CAUTION LIGHTS

The left and right main fuel tank boost pump caution lights (figure 1-65), placarded **L-MAIN PUMP** and **R-MAIN PUMP**, respectively, come on when fuel pressure at the outlet of the indicated fuel boost pump is low.

WING TANK BOOST PUMP SWITCHES

Two wing tank boost pump switches (figure 1-10) are placarded **BOOST PUMPS**, with positions **L-WING-R** and **OFF**. L and R supply left and right AC bus power to the respective wing boost pump. The pumps will automatically stop when the tank float switch senses an empty tank. **OFF** deactivates the respective boost pump.

LEFT AND RIGHT WING BOOST PUMP CAUTION LIGHTS

The left and right wing fuel tank boost pump caution lights (figure 1-65), placarded **L-WING PUMP** and **R-WING PUMP**, respectively, come on when fuel pressure at the outlet of the indicated fuel boost pump is low.

FUEL SYSTEM CONTROL PANEL

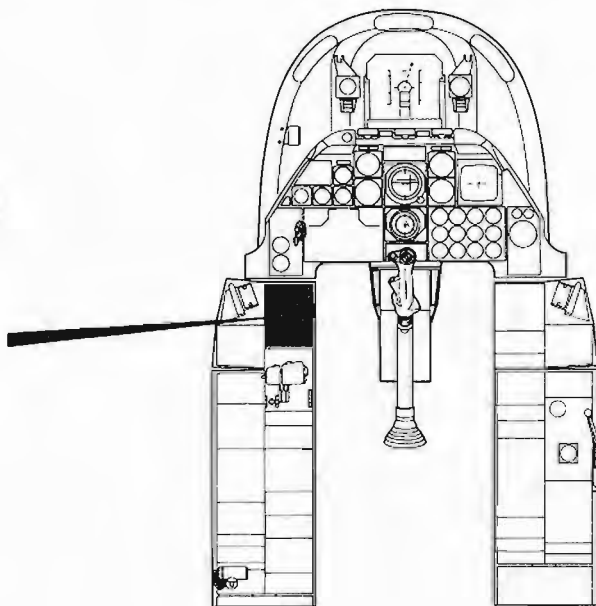
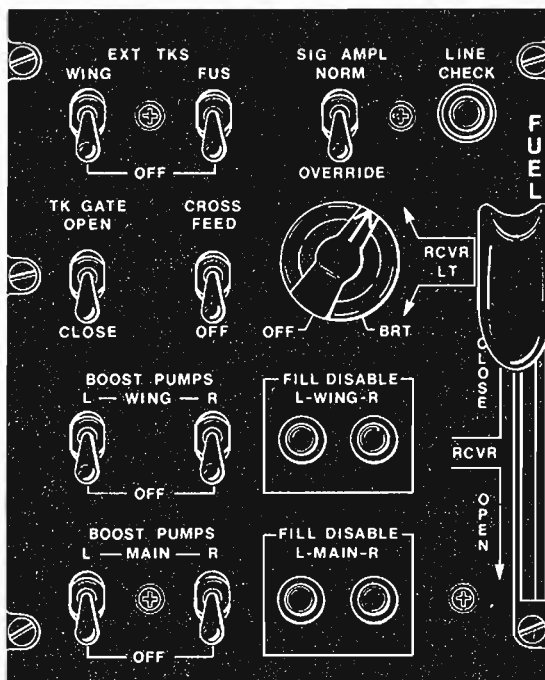

Figure 1-10

EXTERNAL TANK SWITCHES

Two external tank switches (figure 1-10), placarded EXT TKS, are located on the fuel system control panel. One switch is placarded WING and OFF, the other is placarded FUS and OFF. WING and FUS supply auxiliary DC essential bus power to pressurize the external tanks, using bleed air. The fuel is transferred to the main and wing tanks through the refueling manifold. When the tanks are empty or not transferring fuel, they are vented to the atmosphere. OFF depressurizes and vents the associated tank(s). However, if the left or right main tank low level switch is actuated due to low fuel, external fuel, if available, will automatically transfer to the main tanks even if the external tank switches are OFF.

CROSSFEED SWITCH

The crossfeed switch (figure 1-10) is a two-position switch, placarded CROSSFEED and OFF. In CROSSFEED, two auxiliary DC essential bus-powered valves open to allow any operating boost pump to feed both engines. When OFF, the valves close, isolating the two fuel systems.

TANK GATE SWITCH

The tank gate switch (figure 1-10) is a two-position switch placarded TK GATE, with positions placarded OPEN and CLOSE. OPEN supplies auxiliary DC essential bus power to open the gate valve linking the left and right main fuel tanks. Fuel in the main tanks will be below the tank gate valve and will not transfer in level flight when the fuel level is below 1,300 pounds in each main tank. The sump fuel will not flow between the tanks. CLOSE closes the gate valve.

If the tank gate is used in other than relatively level unaccelerated flight, monitor fuel quantity for excessively large cg shift due to fuel transfer. Fuel venting may be noted in this situation.

LEFT AND RIGHT TANKS UNEQUAL CAUTION LIGHT

The left and right fuel tanks unequal caution light (figure 1-65), placarded L-R TKS UNEQUAL, comes on when an imbalance of 750(±250) pounds in fuel

quantity is sensed between the two main fuselage tanks. This condition may be verified by checking the fuel quantity indicator.

FUEL SYSTEM OPERATION

Normally, fuel system operation is automatic except for selecting external tanks. The main and wing tank boost pump switches are positioned to L and R. The tank gate switch is positioned to CLOSE. The cross-feed switch is positioned to OFF. With the battery switch in PWR, the DC boost pump is energized when the APU switch is positioned to START, or if either throttle is forward of OFF, and the left main boost pump is inoperative. The DC boost pump supplies fuel to the APU and the left engine. When the left and right AC busses are energized, the left and right main and wing tank boost pumps will operate. External tank fuel will be transferred to the internal tanks as fuel is used, until the external tanks are empty. The wing boost pumps will then supply the respective engine with fuel until the wing tanks are empty, at which time the wing tank boost pumps will automatically shut off. The main boost pumps will then supply the respective engine with the remainder of the fuel in the airplane. In the event of a wing tank boost pump failure, wing tank fuel will gravity feed to its associated main tank. Gravity feed of a full wing tank will not occur until the main tank fuel level is below approximately 600 pounds. Gravity feed of a partially full wing tank will occur at lower main tank fuel level. Dual check valve units in each wing tank gravity feed line prevent reverse fuel flow from the main tanks back into the wing tanks.

When carrying external tanks, fuel sequencing will be as follows:

- External wing tanks
- External fuselage tank
- Internal fuel.

WARNING

- Feeding fuel simultaneously from external wing and fuselage tanks will cause cg shift that may exceed allowable limits.

AIR REFUELING SYSTEM

The aircraft can be refueled in flight from a boom-equipped tanker. The aircraft is equipped with a UARRSI (figure 1-2), located forward of the cockpit. By positioning a lever on the fuel system control

panel, a flush (slipway) door, powered by the right hydraulic system, folds down into the fuselage to expose the air refueling receptacle and to provide a slipway to guide the tanker boom. When the tanker boom is inserted in the receptacle, the nozzle latch rollers are actuated to the locked position, and

refueling transfer commences. Fuel transfer through the receptacle is distributed to the main and wing tanks, and to external tanks if carried. Through use of the fill disable switches, located on the fuel system control panel, the pilot can prevent fuel from entering any specific internal tank suspected of being damaged. As each tank is filled, float-operated fuel shutoff valves within each tank will close, preventing overfill. When refueling is completed, the disconnect of the boom nozzle will normally be accomplished by a signal from the tanker or by the receiver pilot depressing the air refuel disconnect/reset button on the control stick grip. An automatic disconnect will occur when both receiver and tanker systems are completely operational and one of the following occurs:

- Excessive fuel pressure occurs in the receiver fuel manifold
- The tanker boom limits are exceeded (see T.O. 1-1C-1-26).

Refer to T.O. 1-1C-1 for basic flight crew air refueling procedures and T.O. 1-1C-1-26 for A-10 flight crew air refueling procedures.

If the right hydraulic system fails, the spring-loaded slipway door will open when the air refuel control is set to OPEN. The time for the door to open sufficiently to expose the receptacle is improved by reducing speed and will occur within approximately 3 minutes at 150 KIAS. Aerodynamic effect will open the door sufficiently to expose the receptacle lights and permit emergency "stiff boom" refueling with or without a READY light. Applying boom nozzle pressure on the slipway door should result in the slipway door downlock engaging and a READY light. The LATCHED and DISCONNECT lights will not come on in this case.

Air Refuel Control

The air refuel control (figure 1-10) is placarded RCVR, with two positions OPEN and CLOSE. When OPEN, the left DC bus powers the signal amplifier and the hydraulic control valve. The slipway door opens and the READY light comes on when the door is locked open. When the boom nozzle is inserted in the receptacle, the latches close, securing the nozzle, the LATCHED light comes on and the READY light goes off. After the nozzle is removed from the

receptacle the DISCONNECT light comes on. CLOSE directs hydraulic pressure to close the slipway door and the DISCONNECT light goes off. In the event of loss of hydraulic pressure, OPEN releases a lock allowing the spring-loaded slipway door to open.

NOTE

- Fuel in external tanks will not feed with the air refueling control in OPEN.

Fill Disable Switches

The four fill disable switches (figure 1-10) are similar to circuit breakers. Two switches are placarded L-MAIN-R and two are placarded L-WING-R. If a main or wing tank is damaged, pulling up the respective switch prevents that tank from being refueled. The switches are powered by the left DC bus.

Signal Amplifier Switch

The signal amplifier switch (figure 1-10) provides for emergency refueling. The switch is placarded SIG AMPL and has two positions placarded NORM and OVERRIDE. During the normal refueling cycle, the switch remains in NORM, and air refueling system power and actuating signals function automatically. If a failure occurs, fuel may not be transferred or the tanker boom may not stay latched. In this case, the override switch should be placed to OVERRIDE. In OVERRIDE no signals are passed to the tanker, and the tanker cannot actuate the disconnect cycle. Disconnect is accomplished by depressing the air refuel disconnect/reset button on the control stick. The signal amplifier switch is powered by the left DC bus.

Air Refuel Disconnect/Reset Button

An air refuel disconnect/reset button (time shared with Maverick Track and AIM-9 ¹⁰³) is provided on the control stick grip (figure 1-17). Setting the air refuel control to OPEN activates this button. With the boom nozzle inserted in the receptacle and the LATCHED light on, a disconnect may be accomplished by depressing the air refuel disconnect/reset button. If the DISCONNECT light is on, depressing the air refuel disconnect/reset button recycles the system to the ready mode.

Air Refuel Line Check Button 97

The air refuel line check button (figure 1-10) is a push-button switch placarded LINE CHECK. Momentarily depressing this button checks the air refuel manifold integrity through a time delay relay. If the manifold is damaged, inflowing fuel will be discharged overboard with the possibility of fire and explosion. When the button is depressed before operating the air refuel door, the internal tank shutoff valves are closed and the air purge valve opens allowing air to pressurize the air refueling manifold. One engine must be operating at 85% core rpm or the APU must be operating to supply sufficient air pressure for the READY light to come on if the manifold is intact. The READY light comes on when the air pressure builds up in the manifold (approximately 1–3 minutes). The light will go off approximately 3 minutes after the line check button is depressed. However, the light will remain on as long as the wing tanks are above approximately 1625 pounds. If the READY light does not come on within 3 minutes after the line check button is depressed, the refuel manifold is damaged. In this case, air refueling should not be attempted unless absolutely necessary.

Air Refuel Status Lights

The air refueling status indication is provided by three lights (6, figure FO-1) placarded READY, LATCHED, and DISCONNECT. When the slipway door is fully open and locked, the READY light comes on. Once the tanker boom nozzle and the refueling receptacle are connected, the READY light goes out and the LATCHED light comes on. When the boom nozzle and refueling receptacle are disconnected for any reason, the LATCHED light will go out and the DISCONNECT light will come on. The DISCONNECT light will remain on until the air refuel control is moved to CLOSE or the air refuel disconnect/reset button is depressed.

Air Refueling Exterior and Receptacle Lighting

Aircraft lighting is provided for night refueling operations. These systems are described under Lighting System, Exterior Lights, in this section.

Air Refueling Intercommunications

With some tankers, secure interphone is available between aircraft when the signal amplifier switch is in NORM and the LATCHED light is on. The intercom system is powered by the DC essential bus. Controls for this system are described under INTERCOM control panel, in this section.

ELECTRICAL POWER SYSTEM

The electrical power system (figure FO-5) provides DC and AC power. The battery produces DC to power essential equipment which provides the aircraft with a limited instrument flight capability. The instrument inverter changes DC from the battery to AC to power essential equipment. DC produced by the battery is adequate to start the APU. When operational, the APU generator produces sufficient AC and DC (through the converters) to power all electrical busses indefinitely, provided electrical load is minimized. With engines running, two generators take over production of AC and DC (through the converters) to power all busses. External power can also be used to power all AC and DC (through the converters) busses. The cockpit battery switch is shown in figure 1-11 and the cockpit circuit breaker panel is shown in figure 1-12.

DC SYSTEM**Battery**

The battery is a 24-volt nickel cadmium type, and supplies DC to the battery, DC essential, and auxiliary DC essential busses.

External Battery Switch

The external battery switch (figure 1-71), has two positions placarded ON and OFF. The switch is spring-loaded to ON, and is held in OFF by a safety pin. When ON, this switch allows the battery to supply DC to the battery bus.

Battery Bus

The battery bus (figure FO-5) provides DC so that certain equipment can be operated when the cockpit battery switch is off.

Cockpit Battery Switch

The cockpit battery switch (figure 1-11), placarded BATTERY, has two positions placarded PWR and OFF. The switch is located on the electrical power control panel. PWR allows the battery to supply the DC essential and auxiliary DC essential busses, and OFF disconnects the battery from these busses.

DC Essential Bus and Auxiliary DC Essential Bus

The DC essential and auxiliary DC essential busses (figure FO-5) provide DC to equipment deemed essential for flight.

Converters

Left and right converters convert AC from the APU generator, external source, or generators to DC. When operational, the converters automatically replace the battery as the DC power source for the

battery, DC essential, and auxiliary DC essential busses; and also supply the left DC, right DC, and DC armament busses. The converters normally provide DC to their respective left or right busses. However, either converter can supply both busses if one converter is not operating.

ELECTRICAL POWER CONTROL PANEL

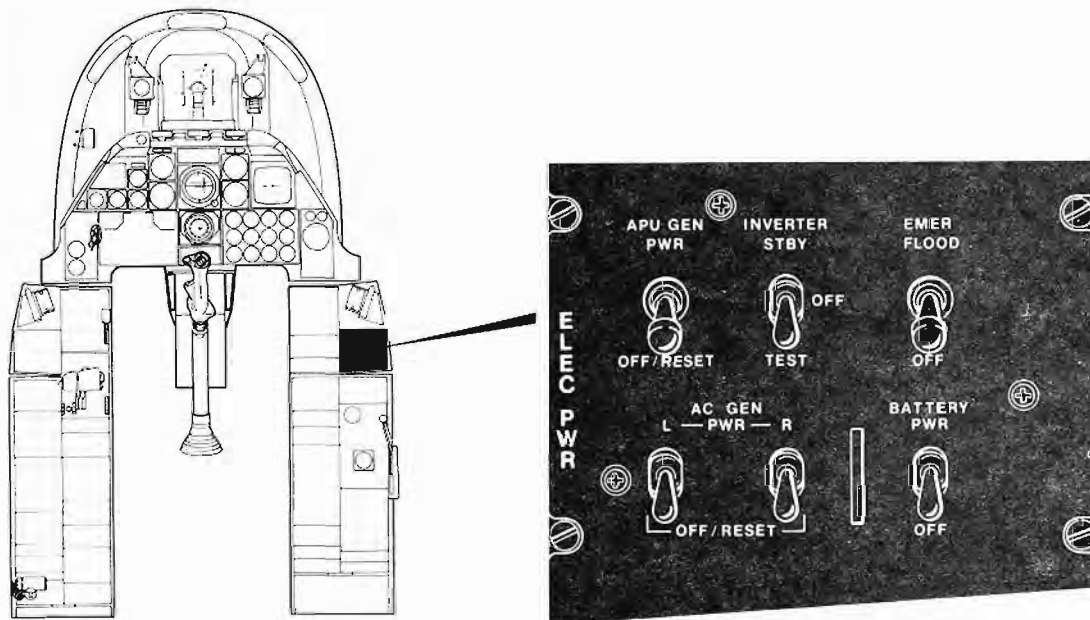

1A-10A-1-35

Figure 1-11

Converter Caution Lights

The left and right converter caution lights (figure 1-65) are placarded L CONV and R CONV. These lights will come on to indicate failure of the associated converter. If either generator fails, the associated converter caution light should remain off, indicating automatic transfer to the operating system.

Left DC Bus, Right DC Bus, and DC Armament Bus

The left DC, right DC, and DC armament busses (figure FO-5) provide DC to mission support equipment and those systems not deemed essential to flight.

AC SYSTEM

Instrument Inverter

The instrument inverter changes DC supplied by the battery to AC. AC from the inverter powers the AC essential, auxiliary AC essential, and AC instrument transformer busses, when the left and right AC busses are not energized or the instrument inverter switch is set to TEST.

AC Essential Bus, Auxiliary AC Essential Bus, and AC Instrument Transformer Bus

The AC essential, auxiliary AC essential, and instrument transformer busses power equipment (figure FO-5) needed for starting engines and operating engine instruments.

CIRCUIT BREAKER PANEL

CIRCUIT BREAKER IS PLACARDED
 RUDDER AUTH LIMIT ON 30

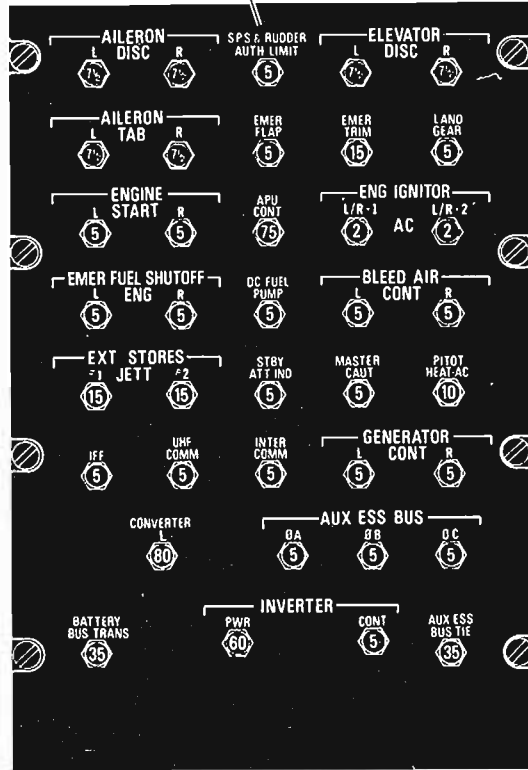
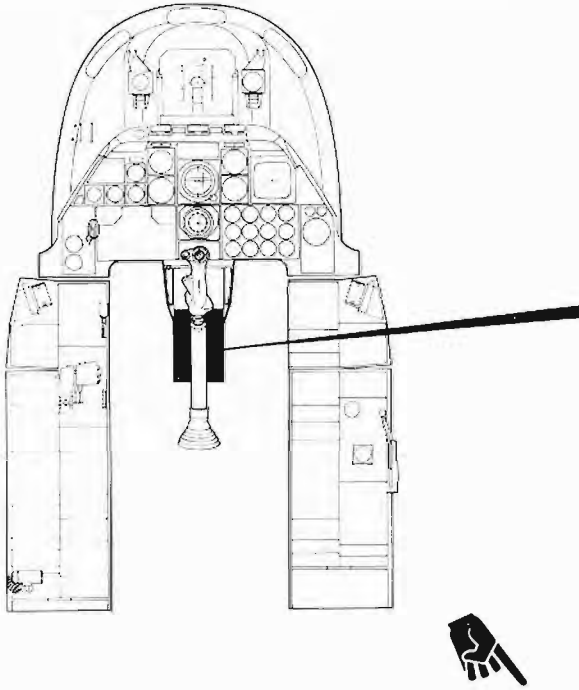

CB	RESULT OF POPPED CB
AILERON DISC L/R	DISCONNECTOR STAYS IN LAST POSITION.
AILERON TAB L/R	AIL SHIFTER IN LAST POSITION. TAB LIGHT INOP. ASSOCIATED HYD SHUTOFF VALVE - OPEN.
ENGINE START L/R	ENG STARTERS AND IGN INOP. ASSOCIATED MAIN FUEL LOW AND MAIN PUMP LTS INOP. AUTO FEEDING OF EXT FUEL AT LOW FUEL INOP.
EMER FUEL SHUTOFF ENG L/R	FIRE HANDLE FUEL SHUTOFF - INOP.
EXT STORES JETT #1/#2	ONE OF DUAL JETT SYSTEMS INOP WITH EACH CB THAT IS OUT.
IFF	IFF INOP - ALL MODES.
UHF COMM	UHF RADIO INOP.
CONVERTER L	BATTERY OR R CONVERTER MUST SUPPLY DC.
BATTERY BUS TRANS	BATTERY ONLY DC SOURCE AVAILABLE TO BATTERY BUS.

CB	RESULT OF POPPED CB
SPS & RUDDER AUTH LIMIT	RUDDER TRAVEL REMAINS $\pm 25^\circ$ ABOVE 240 KIAS. LIMITER INOP. SPS TONES INOP.
EMER FLAP	EMER FLAP RETRACT INOP.
APU CONT	APU AND DC FUEL PUMP INOP.
DC FUEL PUMP	DC FUEL PUMP INOP.
STBY ATT IND	SAI AVAILABLE FOR 9 MINUTES MAXIMUM.
INTER COMM	ALL INTERCOM PANEL AND RWR AUDIO INOP (LDG GEAR AND AOA TONES REMAIN).
INVERTER PWR	INVERTER DISCONNECTED FROM BUSES. NO EFFECT IF GEN-ON LINE.
INVERTER CONT	INVERTER INOP. NO EFFECT IF GEN-ON LINE.

CB	RESULT OF POPPED CB
ELEVATOR DISC L/R	DISCONNECTOR STAYS IN LAST POSITION.
EMER TRIM	EMER TRIM INOP.
LAND GEAR	NORM LDG GEAR EXTEND/RETRACT, NORM WHEEL BRAKES, NOSEWHEEL STEERING, AND ANTI-SKID INOP.
ENG IGNITOR L/R-1/-2	A SET OF IGNITORS (ONE IN EACH ENG) INOP WITH EACH CB THAT IS OUT.
BLEED AIR CONT L/R	ASSOCIATED BLEED AIR VALVE OPEN.
MASTER CAUTION	MASTER CAUT AND CAUT LIGHTS INOP.
PITOT HEAT AC	HTR IN PITOT TUBE ONLY INOP.
GENERATOR CONT L/R	IF GEN-ON LINE - NO EFFECT. IF GEN-OFF LINE - WILL NOT COME ON OR RESET.
AUX ESS BUS	AUX AC ESSENTIAL AND 26V INST TRANSFORMER BUSES INOP (LOSS OF ENG INSTRUMENTS).
AUX ESS BUS TIE	AUX DC ESSENTIAL BUS INOP.

1-10A-1-36

Figure 1-12

Instrument Inverter Switch

The instrument inverter switch (figure 1-11), placarded INVERTER, has three positions placarded STBY, OFF, and TEST (spring-loaded to OFF). STBY allows the APU generator, external source, inverter, or engine driven generators to supply AC to the busses to which they are connected. OFF shuts off AC from all sources to the AC essential bus, and causes the INST INV caution light to come on. TEST cuts off AC to the AC essential bus from all sources except the inverter, permitting a test of the inverter's ability to operate properly. Proper inverter operation is indicated by the INST INV caution light remaining off or coming on momentarily. The INST INV light will remain on if the inverter fails to operate.

Instrument Inverter Caution Light

The instrument inverter caution light (figure 1-65), placarded INST INV, comes on to indicate that the AC essential, auxiliary AC essential, and AC instrument transformer busses are not receiving AC power.

Integrated Drive Generators

An IDG unit is mounted on each engine. Each unit consists of a drive system and AC generator.

Generators

Left and right generators produce AC power. Each generator is capable of supplying sufficient power for all AC busses, and either will automatically pick up the load if the other fails. Cockpit control of the generators is provided by generator switches.

Generator Switches

Two AC generator switches (figure 1-11) are placarded AC GEN L and R. Each switch has two positions placarded PWR and OFF/RESET. In PWR, the associated generator is placed on the line, provided the corresponding generator control unit senses that the output is within limits.

If limits are exceeded, as indicated by a L- or R-GEN caution light coming on, the affected generator will go off the line. The system may be reset by momentarily cycling the applicable generator switch to OFF/RESET and back to PWR. If the fault remains, the system will not reset. Placing an AC GEN switch in OFF/RESET removes the generator from the line.

Generator Caution Lights

The left and right generator caution lights (figure 1-65) are placarded L GEN and R GEN. If a generator caution light comes on, it indicates the associated generator has automatically shut down because AC output was out of limits.

Left AC Bus, Right AC Bus, and AC Armament Bus

The left AC, right AC, and AC armament busses (figure FO-5) provide AC power to mission support equipment and systems not deemed essential to flight.

External Power

External power can be used to supply all AC busses directly, and all DC busses through the converters. A standard receptacle (figure 1-71), on the forward underside of the fuselage, is provided for ground connection of external power. Inserting the plug of the external power unit depresses a contactor button and enables the system. When power is available from both the external source and APU generator, the first one selected automatically locks out the other. With external power supplied to the aircraft, the first engine driven generator to come on line will supply power to its associated bus, and the external source will continue to supply the opposite system. When the second engine driven generator comes on line, the external power is automatically locked out. During engine shut down, when the generator drops off the line, the associated left/right busses will be supplied with power from the external source, if one is connected.

ELECTRICAL SYSTEM OPERATION

With all cockpit electrical switches off and the external battery switch in OFF, no electrical power is being supplied to any aircraft system. When the external battery switch is ON, power is supplied to the battery bus. When the cockpit battery switch is set to PWR, the DC essential and auxiliary DC essential busses are energized. Setting instrument inverter switch to STBY powers the AC essential, auxiliary AC essential, and instrument transformer busses. When the APU is started and the APU generator switch is set to PWR, the left and right AC busses and AC armament bus are energized, as well as the left and right converters. The left converter powers the left DC bus and the right converter powers the right DC bus and the DC armament bus.

In addition, when the APU generator comes on line, the inverter reverts to the standby mode and the APU generator picks up the load formerly carried by the inverter (AC essential, auxiliary AC essential, and instrument transformer busses). At this point, the entire electrical system is powered by the APU generator. After engine start, the first engine driven generator to come on the line powers the entire system and locks out the APU generator. When the second engine driven generator comes on the line, the two share the total load. The left generator powers the left AC, AC essential, auxiliary AC essential, and instrument transformer busses, and the left converter. The right generator powers the right AC and AC armament busses, and the right converter. Together, the left and right generators provide power, through the converters, to the DC essential, auxiliary DC essential, and battery busses. In the event of a failure of either engine driven generator, the load of the failed system will automatically transfer to the operating system. If both engine driven generators fail, the system can again be powered by the APU generator. Turn off nonessential electrical equipment. If the APU generator then fails, essential AC and DC power will be provided by the battery and the instrument inverter. If the converters fail, the battery will supply the DC essential, auxiliary DC essential, and battery busses.

HYDRAULIC POWER SUPPLY SYSTEM

The hydraulic power supply system (figure FO-6) consists of two fully independent hydraulic power systems, designated left hydraulic system and right hydraulic system. Both systems are pressurized by identical engine driven pumps. A small accumulator in each system stabilizes the pressure. In addition to the two system hydraulic pumps, an APU hydraulic pump can be selected for ground use only to provide hydraulic power to either hydraulic system, but not both simultaneously. The selector valve is accessible through the APU access door on the bottom of the aft fuselage.

The left hydraulic system powers the following systems:

- Flight control — Left rudder, left elevator, left and right aileron, flaps
- Landing gear — Landing gear extend and retract, wheel brakes, anti-skid, and nosewheel steering
- Armament — One half of gun drive

The right hydraulic system powers the following systems:

- Flight control — Right rudder, right elevator, left and right aileron, speed brakes, slats
- Emergency systems — Auxiliary landing gear extend, emergency wheel braking and associated accumulators
- Armament — One half of gun drive
- Air refueling — Slipway door and receptacle lock

The hydraulic systems are designed for combat survivability. The left and right systems are physically separated as much as possible. The landing gear, gear uplock, wheel brake, and nosewheel steering lines are isolated from the left system pressure when the gear is up and locked. The landing gear and associated systems can also be isolated from the left hydraulic system by opening the LAND GEAR circuit breaker. The speed brakes are isolated from right system pressure when the speed brake switch is in hold or by selecting SPD BK EMR RETR on the emergency flight control panel. Flaps can be totally isolated from the left hydraulic system by selecting FLAP EMER RETR on the emergency flight control panel.

HYDRAULIC SYSTEMS PRESSURE GAUGES

Two hydraulic pressure gauges (46, figure FO-1) permit the pilot to continuously monitor both hydraulic systems. These gauges are placarded HYD SYS L and HYD SYS R and indicate pressure in psi. The gauges are powered by the instrument transformer bus.

HYDRAULIC PRESSURE CAUTION LIGHTS

Two hydraulic pressure caution lights (figure 1-65), on the caution light panel, are placarded L HYD PRESS and R HYD PRESS. The lights will come on if the pressure in the respective system drops below 900(±100) psi. The light will go off when the pressure returns to a level above 1,000 psi.

HYDRAULIC RESERVOIR LOW LEVEL CAUTION LIGHTS

Two hydraulic reservoir low level lights (figure 1-65), on the caution light panel, are placarded L HYD RES and R HYD RES. The lights will come on whenever the respective reservoir fluid level falls below a preset level.

LANDING GEAR SYSTEM

The landing gear system (figure 1-13) is a tricycle configuration with the main gear retracting into pods suspended below the wing and the nose gear retracting into the fuselage. The nose gear is offset to the right of the aircraft centerline to accommodate the centerline location of the 30mm gun. All three landing gear struts retract forward to aid free-fall auxiliary extension. Landing gear extension and retraction is controlled by the landing gear handle and powered by the left hydraulic system. In the gear-retracted position, the system is depressurized and isolated. In the normal gear down position, the system is pressurized.

Auxiliary extension of the landing gear is available in the event left hydraulic system pressure is not present or if the landing gear handle or valve is jammed or failed. The system requires no electrical power. To actuate the auxiliary landing gear extension system, the pilot must pull the landing gear auxiliary extension handle to its stop.

When the handle is pulled to its stop, right hydraulic system pressure releases the uplocks. If right hydraulic system pressure is not present, the landing gear emergency accumulator, located in the nose wheel well, automatically serves as the pressure source. This accumulator is pressurized by, but isolated from, the right hydraulic system. Upon release of the uplocks, all three gear will extend by gravity, aided by aerodynamic forces. Should left hydraulic system pressure be present, landing gear extension by the auxiliary system can be accomplished by first opening the LAND GEAR circuit breaker to deactivate the landing gear control circuit.

Pulling of auxiliary landing gear extension handle, in addition to releasing the uplocks, directs the same hydraulic pressure to a valve, which depressurizes the left hydraulic system reservoir and thereby minimizes the back pressure against which the gear must fall.

Should the auxiliary landing gear handle be pulled with the LAND GEAR circuit breaker closed, left hydraulic system pressure present, and the landing gear handle up, the landing gear will be powered to the up position as soon as the uplocks are released, and the landing gear will be held in the retracted position by hydraulic pressure. Auxiliary landing gear extension can be accomplished when in the manual reversion flight control mode without opening the LAND GEAR circuit breaker, as both the left and right hydraulic pressure systems are shut off in this mode.

Components of the landing gear system are the main landing gear, nose landing gear, wheel brake system, emergency brake system, anti-skid devices, and nosewheel steering system. In addition, the landing gear system includes a landing gear position and warning system, and a downlock override control. Switches sense gear and uplock position to provide cockpit indications and to depressurize/isolate the landing gear hydraulic system after retraction.

MAIN LANDING GEAR

The shock struts provide a rough field taxi capability. The landing gear retracting cylinder is also the drag brace. A spring-powered mechanical downlock automatically engages both for powered and free-fall gear extensions. Switches provide cockpit indication of downlock.

For gear retraction, hydraulic pressure unlocks the downlock and then extends the retracting cylinder piston to push (rotate) the gear forward and up. As the gear approaches the upstop, an uplock is engaged (see figure 1-13). Also, gear up pressure automatically applies brake pressure to stop wheel rotation before the wheels retract into the gear pods.

For gear extension, hydraulic pressure disengages the uplock hooks and simultaneously retracts the cylinder piston to pull down the gear. Extend pressure is maintained with the gear handle in DOWN.

When retracted, a spring-loaded snubber contacts the tire to prevent air drag rotation of the wheels.

NOSE LANDING GEAR

The nose landing gear operates similar to the main gear. As the strut extends when weight comes off the tire, a cam centers the nosewheel. Two doors seal off the fuselage compartment after gear retraction.

LANDING GEAR HANDLE

The landing gear handle (33, figure FO-1) is wheel-shaped and placarded LDG GEAR DOWN. The handle can only be moved from DOWN to up when DC essential power is available and the aircraft weight is off the wheels, or when the landing gear DOWNLOCK OVERRIDE button is depressed while moving the landing gear handle up.

The handle must be pulled aft before moving it to DOWN.

Normally the time for the gear to extend or retract is approximately 6 seconds.

LANDING GEAR SYSTEM SCHEMATIC

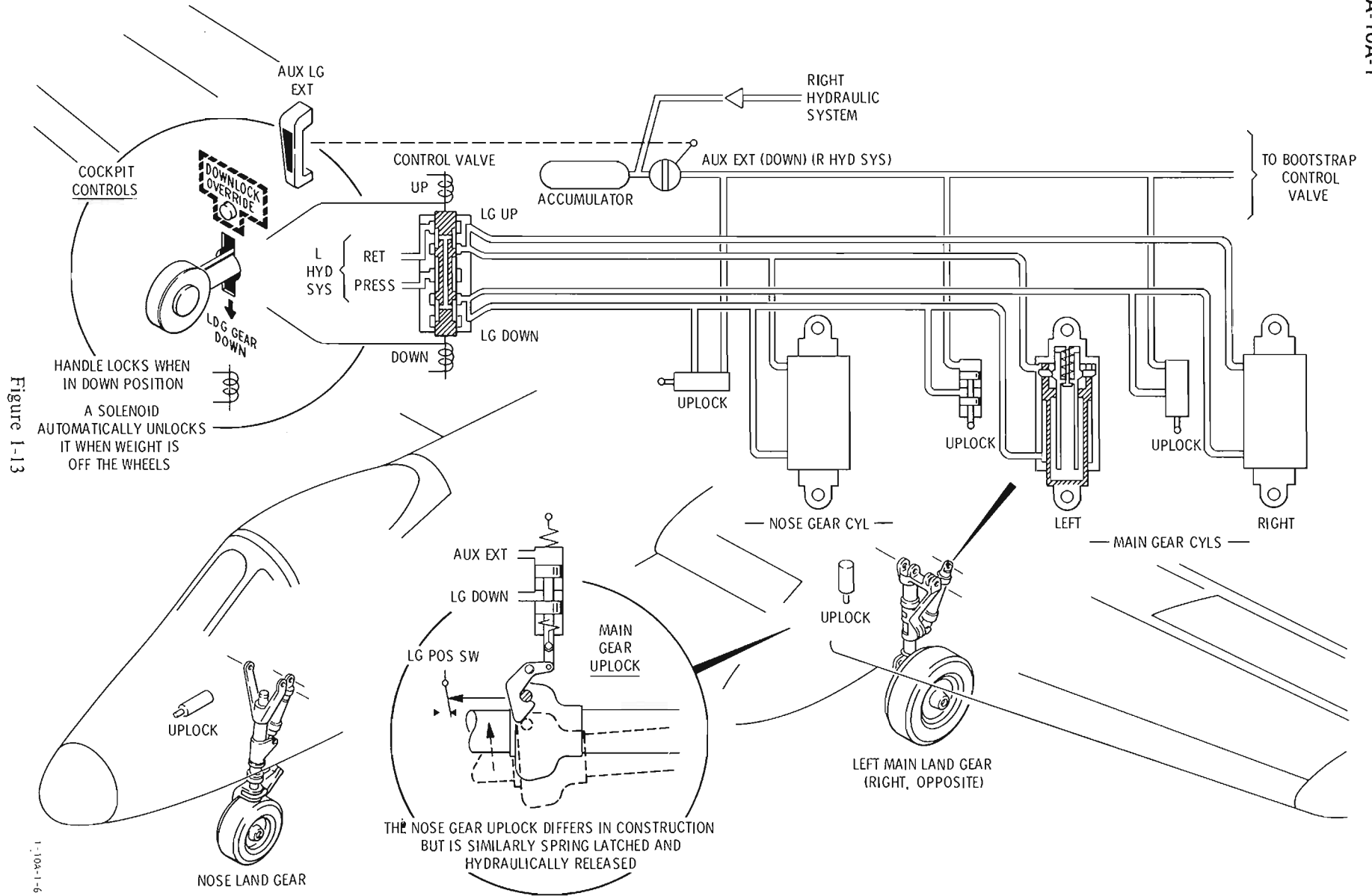

Figure 1-13

1-10A-1-6

DOWNLOCK SOLENOID OVERRIDE BUTTON

The downlock solenoid override button (33, figure FO-1), is located on the landing gear control panel and placarded DOWNLOCK OVERRIDE. Depressing the button allows the landing gear handle to be moved to UP even if aircraft weight is on the main gear. However, the nose and main gear will not retract until weight has been removed from the main gear and both struts have extended. The button is powered by the DC essential bus.

CAUTION

- If the downlock override is used in flight with a broken scissors or uninflated strut, damage to the gear or aircraft could result.

AUXILIARY LANDING GEAR EXTENSION HANDLE

An auxiliary landing gear extension handle (48, figure FO-1), placarded AUX LG EXT, permits extension of the landing gear in the event of left hydraulic system failure or if the landing gear handle or valve is jammed or failed. A button at the top of the auxiliary landing gear extension handle must be depressed before the handle can be pulled out. Extension of the landing gear by the auxiliary system without left hydraulic system pressure should be accomplished by first placing the landing gear handle DOWN and then pulling out the auxiliary landing gear extension handle. The auxiliary landing gear extension handle should be returned to its stowed position as soon as the landing gear are down and locked.

Extension of the landing gear by the auxiliary system when left hydraulic system pressure is present should be accomplished by first opening the LAND GEAR circuit breaker, placing the landing gear handle DOWN, and finally pulling out the auxiliary landing gear extension handle. The auxiliary landing gear extension handle should be returned to its stowed position as soon as the landing gear are down and locked to preclude left hydraulic gear are system pump cavitation in the event a heavy demand is imposed upon the system.

Landing gear retraction after extension by the auxiliary system with left hydraulic system pressure present should be accomplished by first checking that the auxiliary landing gear extension handle is stowed, closing the LAND GEAR circuit breaker, and finally placing the landing gear handle up.

After extension by the auxiliary system during intentional manual reversion, the landing gear can be retracted, provided left hydraulic system pressure will be available. The retraction should be

accomplished by first checking that the auxiliary landing gear extension handle is in its stowed position and that the LANDING GEAR circuit breaker is closed, then placing the flight control mode switch in NORM, and finally raising the landing gear handle.

CAUTION

- Allow at least 15 seconds to elapse between returning the auxiliary landing gear extension handle to the stowed position and placing the flight control mode switch in NORM to avoid left hydraulic system pump cavitation.

LANDING GEAR POSITION INDICATING AND WARNING SYSTEM

The landing gear position indicating and warning system consists of three separate green landing gear display lights (32, figure FO-1), red warning lamps within the landing gear handle (33, figure FO-1), and an audible warning signal (beeper).

The three landing gear display lights are placarded L SAFE, N SAFE, and R SAFE. Each display contains two bulbs and comes on green to indicate the respective gear is down and locked.

When the landing gear is up and locked all display lights are off. When the gear handle is placed to DOWN, the warning light and beeper come on and remain on until all three gear are in their locked positions. When the handle is moved up each safedown display light will go off, and the warning light and beeper will come on and remain on until all gear are in their up and locked positions. The beeper will sound and the warning light will come on if the following conditions occur simultaneously:

- Gear handle up
- Below approximately 10,000 feet MSL
- Below approximately 160 KIAS
- A throttle positioned below approximately half-way between IDLE and MAX.

The signal lights test button (figure 1-65) causes the landing gear display lights and the landing gear warning light to come on and tests the audible warning signal. The lights coming on tests the lamps only and not the complete circuit.

The landing gear position indicating and warning system is powered by the auxiliary DC essential bus.

LANDING GEAR HORN SILENCE BUTTON

The landing gear horn silence button (figure 1-4) on the throttle quadrant, is placarded L/G WRN SILENCE. Depressing the button will silence the beeper. If the beeper sounds due to an unsafe gear and is silenced, it will not sound again until the gear is recycled. If the beeper sounds due to aircraft configuration (gear not down and locked, altitude below approximately 10,000 feet MSL, airspeed below approximately 160 KIAS and throttle retarded) and is silenced, it will sound again if the throttle is advanced and again retarded. The button is powered by auxiliary DC essential bus.

NOSEWHEEL STEERING SYSTEM

The nosewheel steering system is pressurized by the left hydraulic system. Damping is provided to prevent nosewheel shimmy in the steering and free swivel modes.

Nosewheel steering is available only when the landing gear handle is DOWN and weight is sensed on either main gear. Failure of the circuitry or loss of electrical power will revert the system back to the swivel mode to prevent a hardover. A compensator on the steer/damp unit provides sufficient hydraulic fluid and pressure to retain the shimmy damping function in event of loss of hydraulic power. Nosewheel steering must be engaged, at least momentarily, prior to each flight to insure damping.

NOSEWHEEL STEERING BUTTON

The nosewheel steering button (figure 1-17) is located on the control stick grip. On [61] the button also functions as the HARS fast-erect button. On [62] the HARS function is replaced by an airborne INS mark/update function; authority transfer is automatic as weight comes off both main gear.

Auxiliary DC essential bus power arms the engage switch when weight is on either main gear. Subsequent press and release of the button engages steering. When in steering mode, a press and release of the button disengages steering. A sustained press of the button, regardless of sequence, engages steering.

Any interruption of electrical power disengages steering until the button is again pressed. After landing, nosewheel steering is not engaged until the button is pressed after main gear ground contact.

NOSEWHEEL STEERING ENGAGED ADVISORY LIGHT

The nosewheel steering advisory light (14, figure FO-1), placarded STEERING ENGAGED, will come on to indicate that nosewheel steering has been selected. The light does not necessarily indicate proper functioning of the system. The light is powered by auxiliary DC essential bus.

WHEEL BRAKE SYSTEM

The normal wheel brake system is fully powered from the left hydraulic landing gear-down circuit. The brakes are independently activated by linkage from the rudder pedals.

During landing gear retraction hydraulic pressure stops the main wheels prior to engagement of the snubbers. This brake pressure is released when the landing gear is unpressurized after reaching the up and locked position.

EMERGENCY BRAKE SYSTEM

With the left hydraulic system failed and the right hydraulic system operative, the emergency brake system has the same capabilities as the normal system without anti-skid. In event of a failure of both hydraulic systems, emergency braking power is provided by an accumulator serviced by, but isolated from the right hydraulic system. In event of loss of both hydraulic systems, sufficient accumulator fluid pressure is available for a minimum of five full brake applications. ■

The system is activated by pulling the emergency brake handle, and then actuating the brake pedals. Pulling the handle also actuates a switch which disables the anti-skid system.

The emergency braking system is fully independent of the normal system down to but not including the wheel brake cylinder. In the event left hydraulic pressure becomes available while emergency braking is selected, the emergency system retains control of the brakes.

EMERGENCY BRAKE HANDLE

The emergency brake handle (1, figure FO-2) is placarded EMERG BRAKE. The emergency brake system is engaged by pulling the emergency brake

handle aft which mechanically positions a valve, directing pressure from the right hydraulic system or accumulator to the brakes. If the right hydraulic system is intact, unlimited braking will be available. When the emergency brake handle is pulled, the anti-skid control system is deactivated.

CAUTION

- Emergency brake handle must either be full in or full out to obtain braking.

ANTI-SKID CONTROL SYSTEM

The anti-skid control system enables efficient maximum braking for all runway conditions. Cockpit controls and displays consist of an engage switch, an emergency disengage switch, and a caution light. On landing, either or both main landing gear squat switches arm a locked wheel/touchdown protection circuit which prevents the application of any brake pressure until both wheels have spun up to 25 knots. During light and moderate braking the system usually does not operate. During heavy braking the system automatically releases brake pressure to both wheels regardless of which wheel experiences the skid. The system continues to operate until it senses that wheel rotation has decreased to 10 knots.

In the event that one of the squat switches fails to activate after touchdown, normal skid control is available to approximately 15 knots.

ANTI-SKID SWITCH

The anti-skid switch (30, figure FO-1) is placarded ANTI-SKID and OFF. The switch must be manually moved to ANTI-SKID, where it is electrically held. The switch can be manually moved to OFF and is electrically released to OFF whenever:

- Emergency disconnect lever is actuated
- Emergency brake handle is pulled
- The auxiliary DC essential bus is deenergized.

When the landing gear is raised the anti-skid control elements are deenergized; however, the switch remains engaged. OFF deactivates the system and causes the ANTI-SKID caution light to come on if the landing gear handle is DOWN. The switch does not automatically disengage as a result of the anti-skid caution light coming on or system failure.

ANTI-SKID CAUTION LIGHT

The anti-skid caution light (figure 1-65) is placarded ANTI-SKID. The light serves two functions:

- Indicates the anti-skid system is not engaged when the landing gear handle is DOWN
- Indicates anti-skid system has automatically deactivated in response to a self-detected failure.

EMERGENCY DISCONNECT LEVER

The emergency disconnect lever (figure 1-17) is located on the forward side of the control stick just below the grip. Momentary actuation of the lever immediately deactivates both the anti-skid and SAS systems and the switches go to OFF.

PRIMARY FLIGHT CONTROL SYSTEM

Pilot commands are transmitted via nonredundant pushrods from the stick to the aft area of the armored cockpit (white area), through a set of control disconnectors, and then by redundant cables to the elevators and ailerons, and by a single cable to the rudders. Loss of one hydraulic system does not affect pitch and roll response but does cause moderate increase in pedal force required for yaw inputs. Jams in the pitch or roll control systems, aft of the disconnect units in the white area, may be isolated to free the stick for control of the unjammed portions. Redundant control circuits are provided for trim controls in the pitch and roll axes, while yaw trim is through the yaw SAS. The dual channel SAS provides rate damping in both the pitch and yaw axes as well as automatic turn coordination.

PITCH CONTROL SYSTEM

Pitch control (figure 1-14) is provided by two elevators, which are connected by a shearable crossover shaft. The elevators are powered by independent actuators, which are also connected by a shearable crossover shaft and powered by independent hydraulic systems. Inputs to the actuators are made via independent, widely separated cable and linkage paths which connect directly to the disconnecter units. A single system of pushrods within the white area connect the disconnecter units to the stick. Since the elevators are connected, one actuator will power both elevators in the event of the loss of one hydraulic system. The actuators are connected, so that both actuators (and in turn both elevators) will be operated via a single mechanical control path in the event one control path is lost. Hence, loss of one hydraulic system and/or mechanical control path will have no discernible effect on stick/surface response.

If an elevator, elevator actuator, or control path aft of the disconnecter is jammed, the pilot can disconnect the jammed side of the system using the elevator emergency disengage switch. Stick inputs will then shear the actuator crossover shaft and the elevator crossover shaft. This will free the unjammed side of the system. If a jam occurs with appreciable elevator deflection, pitch authority in the opposite direction will be minimal; e.g., if an elevator is jammed with an upward deflection, pitch down authority will be reduced.

Artificial stick feel is provided by devices located close to the elevator actuators and a bobweight located in the white area. Trim is provided by two independent, electrical circuits: the normal pitch/roll trim control circuit and the emergency override pitch/roll trim circuit. These circuits lead to a trim motor which acts on the artificial feel devices to reposition the actuators and move the entire elevator surface. If both hydraulic systems are lost, pilot pitch trim inputs will automatically operate the two elevator trim tabs via two additional trim motors to provide pitch trim. The geared/trimmable elevator tabs are mounted on the outboard trailing edges of both elevators. The tabs are trimmable in manual reversion, and geared in the powered flight control mode. This reduces elevator aerodynamic loads to levels satisfactory for instantaneous transfer from the powered mode to MRFCs. Refer to PITCH MRFCs section for additional description of pitch manual reversion operation.

Two identical and independent pitch SAS channels provide rate damping for enhanced tracking and pitch trim compensation for speed brake deployment.

ROLL CONTROL SYSTEM

Each aileron is powered by a tandem hydraulic actuator which normally allows each aileron to be powered by both hydraulic systems (figure 1-15). Inputs to the actuators are made through independent, widely separated cable and linkage paths which connect through aileron tab shift mechanisms to the disconnecter units. A single system of pushrods within the white area connects the disconnecter units to the control stick.

If one hydraulic system is lost, the operative system will continue to power both ailerons. Hence, the loss of one hydraulic system has no discernible effect on stick/surface response.

In the event one control path is lost, roll control will be provided by the connected aileron, and roll authority will be reduced by approximately one half. Normal stick force relative to roll rate will be experienced, but the stick will have to be moved twice as much for a given maneuver. If an aileron surface, aileron actuator, or a control path aft of the disconnecter becomes jammed, the aileron emergency disengage switch can be used to free the unjammed aileron. If a jam occurs with appreciable aileron deflection, roll control in the opposite direction will be minimal; e.g. if right aileron is jammed with an upward deflection, roll authority to the left will be reduced.

Artificial stick feel is provided by redundant devices located close to the aileron actuators. Trim is provided by two independent electrical circuits: the normal pitch/roll trim control circuit and the emergency override pitch/roll trim circuit. These circuits lead to a trim motor in each wing. The trim motor acts on the artificial feel device, which in turn repositions the actuator to move the entire aileron surface. Sufficient trim for normal operations can be obtained from one trim motor. However, trim rate and authority will be reduced. Disengagement of an aileron will not cause loss of roll trim. No roll trim will be available in the manual reversion operating mode. (See section on MRFCs.)

Aileron tabs are mounted on the inboard trailing edge of each aileron. During normal flight the tabs

PITCH CONTROL SYSTEM SCHEMATIC

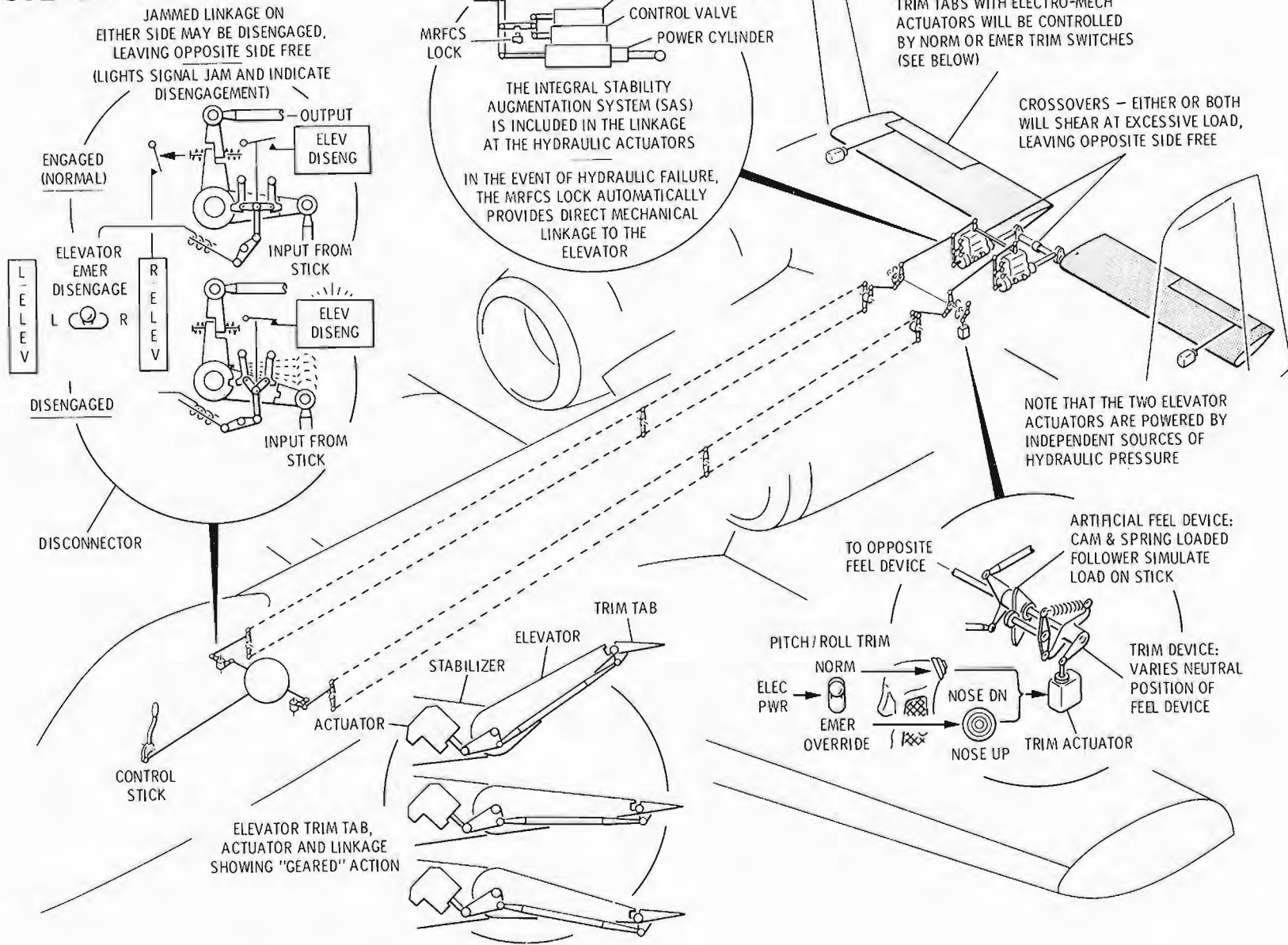
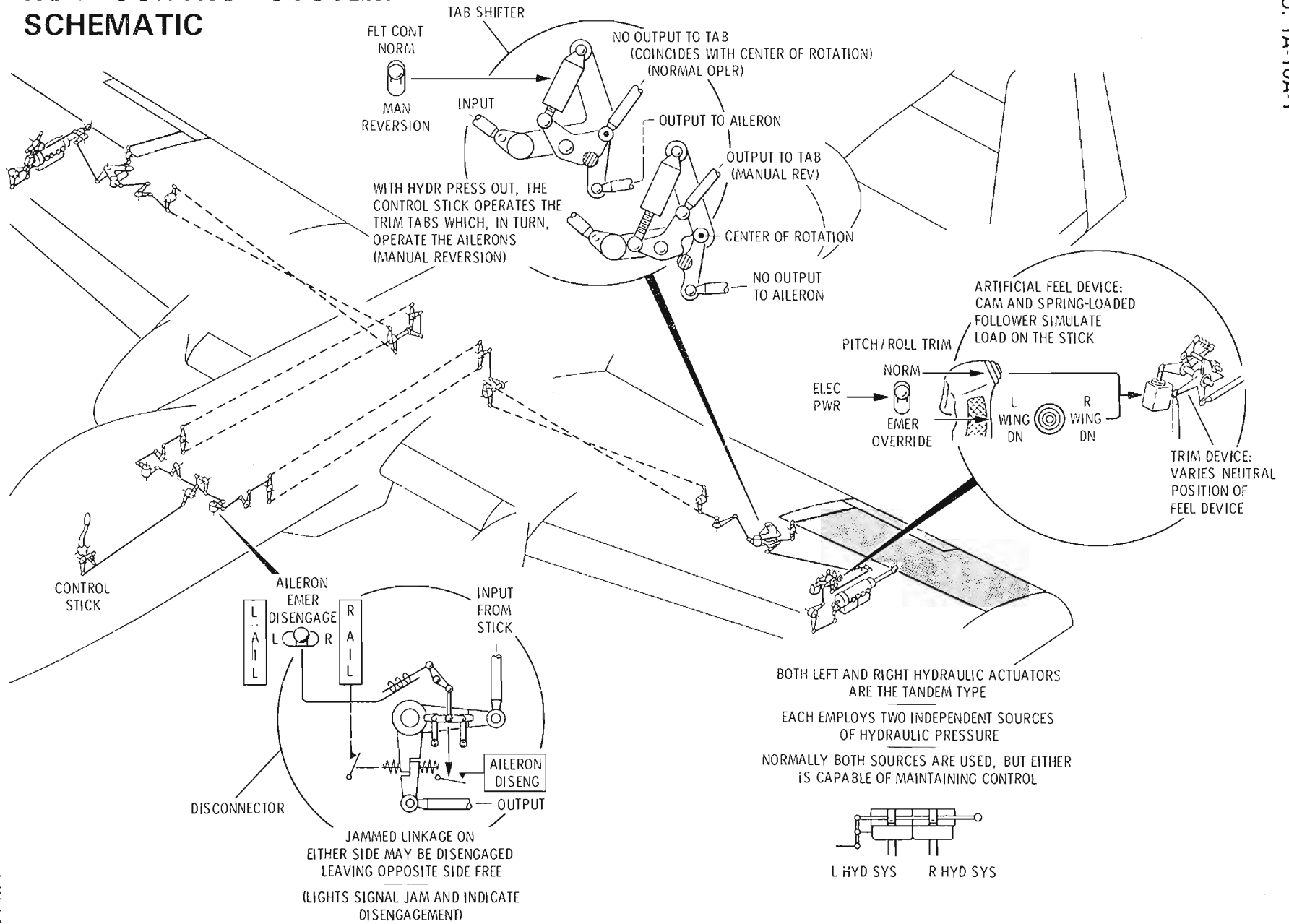

Figure 1-14

1-10A-1-32

ROLL CONTROL SYSTEM SCHEMATIC

Figure 1-15



are geared to reduce the aerodynamic loads on the ailerons, and are not directly controlled by lateral stick inputs. In manual reversion, lateral stick inputs are transmitted directly to the tabs, which in turn fly the ailerons.

Elevator/Aileron Emergency Disengage Switches

Two three-position lever-locked switches (figure 1-18), placarded ELEVATOR EMER DISENGAGE and AILERON EMER DISENGAGE, are mounted on the emergency flight control panel. The switches are normally centered. In the event of a jam of a control path aft of the disconnect units, or a jam in the actuator or control surface, a light adjacent to the appropriate switch will come on as the pilot exerts abnormal stick force countering the jam. The stick is disconnected from the jammed side by moving the appropriate switch toward the light.

The stick becomes immediately free to control the unjammed control path. After disconnecting a jammed elevator stick force will be momentarily higher than normal until the controllable elevator is displaced approximately 3° relative to the jammed surface, at which point the crossover shaft between the two elevator actuators will shear. The subsequent shearing of the elevator crossover shaft will be accomplished with hydraulic-powered inputs.

For both elevator and aileron control jams, the pilot experiences normal stick force per g relative to roll or pitch input, but the stick has to be moved or trimmed approximately twice as much for a given maneuver. When a control path is not fully engaged at the disconnect unit, the ELEV DISENG or AIL DISENG light on the caution light panel comes on. When the switch is subsequently moved to the center position or to disengage the opposite side, the surface will reconnect as soon as the stick is moved in alignment with the surface position. Though remotely possible, both elevators or ailerons can be disconnected, but one surface will automatically reconnect as soon as the stick is moved into alignment with the position of the control surface. The disengage circuits are powered by the DC essential bus.

Elevator/Aileron Disengaged Caution Lights

The elevator and aileron disengaged caution lights (figure 1-65), on the caution light panel, are placarded ELEV DISENG and AIL DISENG. The lights indicate that either or both elevator or aileron control paths are not connected at the disconnect units.

Elevator/Aileron Jam Indicator Lights

The elevator and aileron jam indicator lights (figure 1-18), on the emergency flight control panel, are placarded L ELEV/R ELEV and L AIL/R AIL, respectively. These lights bracket the appropriate disengage switches. The lights are controlled by load-sensing switches in the disconnecter units and are powered from the auxiliary DC essential bus. In the event of an actual jam aft of the disconnect units, a light will come on to identify which side is jammed when the pilot applies 50 - 65 pounds of stick force against the jam. The stick force must be maintained to keep the light on. On [63], the jam light will remain on for 3 - 5 seconds after the stick force required to turn the light on is reduced. The pilot should reduce stick force during disengagement to relieve loads on the disconnect units and also to reduce transients as the disconnecter actuates. The lights may come on when there is no jam condition by the application of stick force and rate in excess of the capacity of the powered actuators to respond. The lights may also come on during manual reversion because of the high stick force gradients.

YAW CONTROL SYSTEM

Yaw control (figure 1-16) is provided by two rudders, which are individually driven by independent hydraulic actuators. The actuators are controlled in unison by a single cable and linkage transmission path which connects to the rudder pedals. Since there is a single control path, there is no disconnect capability in the event of a jam. However, if an actuator or rudder surface becomes jammed, some yaw control from the unjammed rudder may be available due to stretching of the connecting cables between the actuators. Required rudder pedal force will be significantly higher. Full trim authority will be available for the unjammed rudder if the yaw SAS channel on the jammed side is turned off. If one hydraulic system is lost, slightly degraded rudder authority will result. Initial rudder pedal inputs will move only the powered rudder. Then, increases in rudder pedal input will move both the powered and unpowered rudders and the unpowered rudder will trail the powered rudder. Hence, the rudder pedals have to be moved more than normal and there will be a moderate increase in the pedal force required. If both hydraulic power sources are lost, the actuators automatically shift modes to permit direct transfer of rudder pedal inputs to the rudder surfaces. Pedal forces in this mode are higher. Artificial rudder pedal feel and centering characteristics are integrated into both rudder actuators. At aircraft speeds above

YAW CONTROL SYSTEM SCHEMATIC

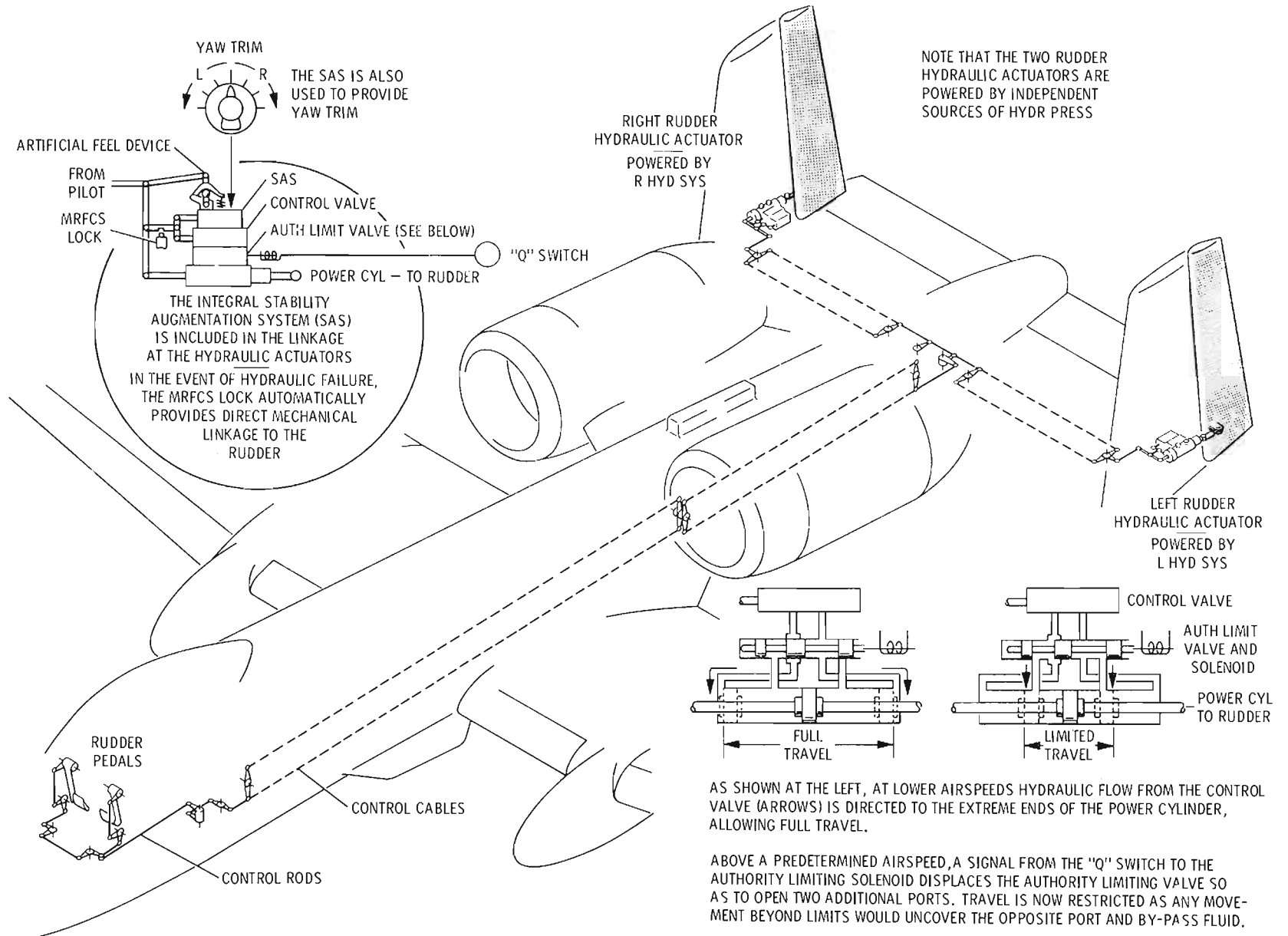
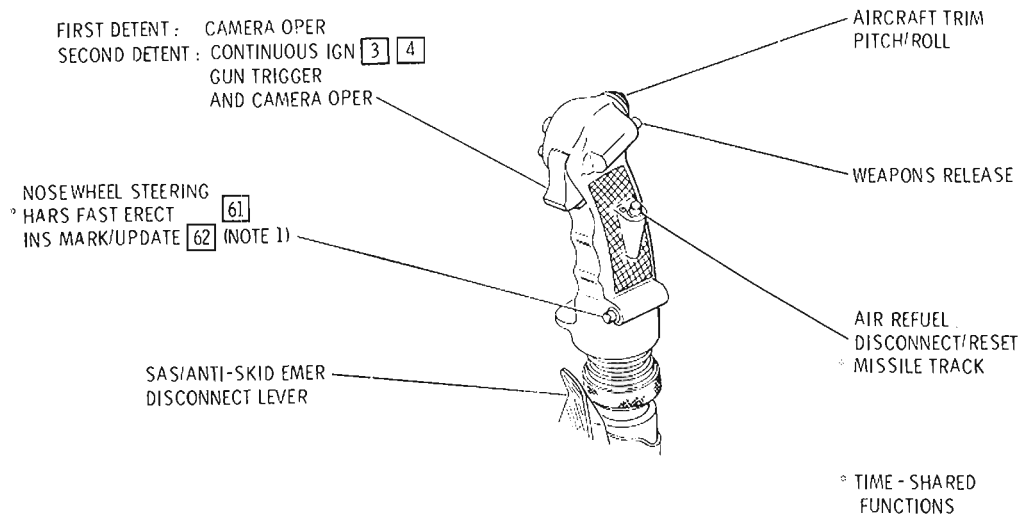

Figure 1-16

CONTROL STICK



NOTE :

1. AIRBORNE FUNCTION ONLY.

1A-10A-1-40

Figure 1-17

240 KIAS, available powered rudder travel is automatically reduced from $\pm 25^\circ$ to $\pm 8^\circ$. If aircraft speed increases through approximately 240 KIAS with rudder inputs greater than $\pm 8^\circ$, rudder pedal "kicks" or "thumps" may be felt as the rudder returns to 8° . Independent SAS signals are electrically transmitted to each rudder actuator to provide automatic turn coordination, yaw damping and yaw trim.

Rudder Pedal Adjustment Handle

The rudder pedals are individually adjustable with a single rudder adjustment handle (50, figure FO-1), located on the upper right side of the center pedestal. When the handle is rotated up, the pedal assemblies are spring-loaded against the pilot's feet. After the rudders are moved to the desired positions, the handle is released and the pedals lock. The pedal positions are numerically identified on the pedal assemblies for visual reference.

PITCH AND ROLL TRIM CONTROL SYSTEMS

The pitch and roll trim control systems are similar in function. Both systems act on the artificial feel devices to vary the zero load position of the stick and equivalent surface positions. A five-position switch, mounted at the top of the stick grip, is used for normal pitch/roll trim control. Trim change is proportional to the time the button is activated. Trim rates are essentially independent of stick loading conditions. In the event of a failure in either the pitch or roll trim circuit, control of both trim axes may be transferred to a similar five-position switch located on the emergency flight control panel. The emergency pitch/roll trim circuitry is powered separately from the normal trim; however, both circuits operate the same trim motors. A roll trim controller transmits trim inputs to the two independent trim motors (one for each aileron) so that the roll trim motors are actuated equally. In the event of a failure on one side, roll trim with the other motor will be available

EMERGENCY FLIGHT CONTROL PANEL

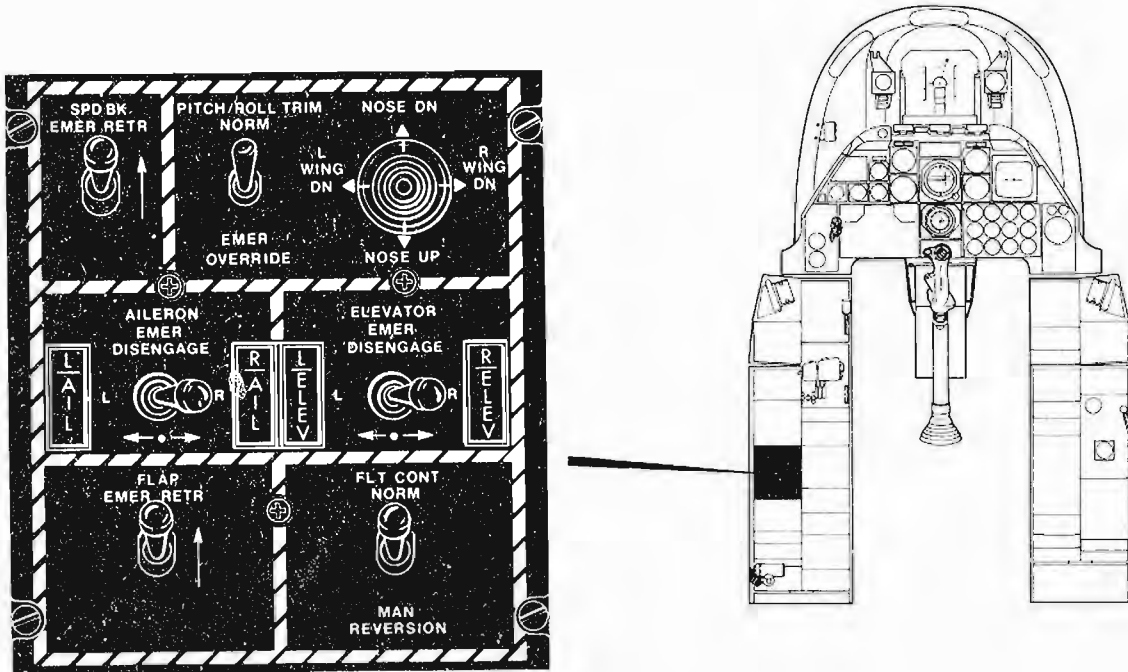

1-10A-1-41

Figure 1-18

but the overall trim authority and trim rate will be reduced. In addition, there will be a noticeable difference in lateral stick feel near the center/neutral position and the stick may not return to a precise lateral center position if released (hands-off).

Pitch and Roll Trim Switch

When the pitch/roll trim override switch is in NORM, aircraft pitch and roll trim is controlled by a trim switch on the control stick grip (figure 1-17). Normal trim switch control circuits are powered by the auxiliary DC essential bus.

Emergency Pitch and Roll Trim Switch

When the pitch/roll trim override switch is in EMER OVERRIDE, aircraft pitch and roll trim is controlled by an emergency pitch and roll trim switch (figure 1-18), located on the emergency flight control panel. The switch is identical to the pitch and roll trim

switch on the control stick grip. Emergency trim switch circuits are powered by the DC essential bus. Hence, aircraft pitch and roll trim may be provided by the emergency pitch and roll trim system in the event of loss of the auxiliary DC essential bus power or a failure in the normal trim circuits.

Pitch/Roll Trim Override Switch

The pitch/roll trim override switch (figure 1-18), placarded PITCH/ROLL TRIM, is a two-position toggle switch located on the emergency flight control panel. When set to NORM, aircraft pitch and roll trim are controlled by the normal trim switch located on the control stick grip. When set to EMER OVERRIDE, aircraft pitch and roll trim are controlled by the emergency trim switch located on the emergency flight control panel. The pitch/roll trim override switch must be in NORM for TAKEOFF TRIM pushbutton switch to operate.

YAW TRIM CONTROL KNOB

Yaw trim control is effected with a knob placarded YAW TRIM (figure 1-19), located on the SAS control panel on the left console. The single knob controls two independent circuits, each of which trims a rudder through the respective YAW SAS channel. Rudder pedals do not move in response to trim inputs. Rudder trim authority is limited to $\pm 10^\circ$ at speeds below 240 KIAS and $\pm 8^\circ$ above 240 KIAS. A detent is provided in the zero trim position. The yaw trim system is powered by the right DC and AC busses.

In the event of loss of one SAS channel or one hydraulic power supply, 50% yaw trim authority is retained through the powered SAS channel.

TAKEOFF TRIM CONTROL SYSTEM

When the T/O TRIM button (figure 1-19) is depressed, the pitch and roll trim motors and the two elevator tab trim motors are driven to neutral. With the T/O TRIM button depressed, the yaw trim knob in neutral setting, and the five trim motors at neutral setting, the TAKEOFF TRIM light comes on. The T/O TRIM button does not operate when the pitch/roll trim override switch is in EMER OVERRIDE.

The takeoff trim circuit is powered by the auxiliary DC essential bus.

Takeoff Trim Button

The takeoff trim button (figure 1-19), placarded T/O TRIM, is a pushbutton located on the SAS control panel. The button must be depressed until TAKEOFF TRIM light comes on, indicating that the surfaces have reached the desired position. When the T/O TRIM button is released, the TAKEOFF TRIM light will go off.

Takeoff Trim Light

A green takeoff trim light (figure 1-19), placarded TAKEOFF TRIM, is located on the SAS control panel. The TAKEOFF TRIM light indicates that all trim surfaces have achieved proper trim for takeoff. The TAKEOFF TRIM light is energized by the auxiliary DC essential bus.

STABILITY AUGMENTATION SYSTEM

The SAS enhances flying qualities for target tracking, reduces pilot workload, and provides yaw trim capability. Two SAS channels are provided in both the pitch and yaw axes. Each channel acts on the

STABILITY AUGMENTATION SYSTEM PANEL

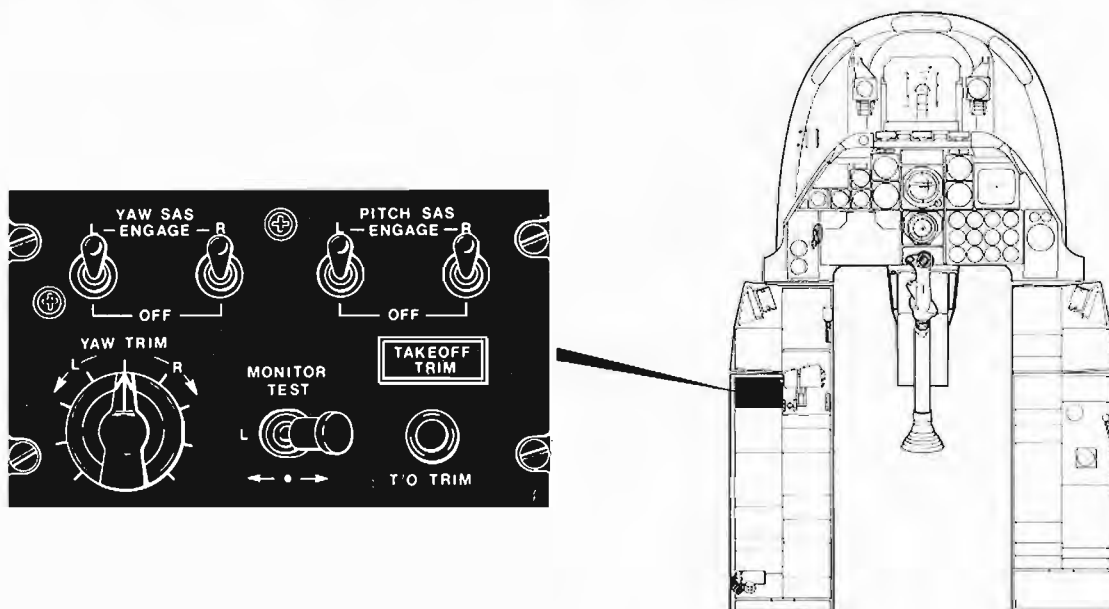

Figure 1-19

respective control surface actuator. The output of the two SAS channels is continuously compared and in the event of an excessive difference, a computer deactivates both channels in the affected axis, triggering a light on the caution light panel.

The pitch and yaw SAS failure monitor circuits can be tested by using the monitor test switch on the SAS panel.

An emergency disconnect lever, located immediately below the stick grip, disengages all SAS channels when momentarily depressed. Hydraulic power is required for the SAS to work. The SAS is powered by the right AC and DC busses.

Monitor Circuit Test Switch

A test switch on the SAS control panel (figure 1-19), placarded MONITOR TEST, is used to check both pitch and yaw SAS failure monitor circuits. The switch is three-positioned and spring-loaded to the midposition where it is lever-locked. When the switch is held to L or R, a simulated failure is introduced in the associated pitch and yaw channels and the monitor circuits disengage all SAS channels.

Emergency Disconnect Lever

The emergency disconnect lever (figure 1-17) is located on the forward side of the control stick below the control grip. The yellow and black striped lever functions as an anti-skid and SAS system disconnect lever. The anti-skid switch and all SAS switches will return to OFF when the lever is actuated.

Pitch SAS

The pitch SAS provides pitch rate damping and pitch trim compensation for speed brake deployment. Total SAS authority is limited to 2° elevator trailing edge up and 5° elevator trailing edge down. A monitor circuit senses differential between the left and right channels and shuts off pitch SAS when the differential is excessive. A hydraulic or engine failure will not automatically result in SAS disengagement. However, the affected axes will disengage when a differential between channels is sensed. Control stick authority is more than sufficient to override a SAS induced elevator displacement.

WARNING

- The pitch SAS fail-safe monitoring feature does not function during single channel SAS operation. Single channel operation will also result in repetitive loading of the elevator interconnect shear bolts. If pitch SAS operation cannot be maintained with both channels engaged, pitch SAS should be left OFF.

Pitch SAS Engage Switches

Two pitch SAS engage switches (figure 1-19) are located on the SAS control panel. These are two-position solenoid-held switches placarded PITCH SAS ENGAGE and OFF with one switch placarded L, and the other placarded R. For normal engagement both switches are actuated simultaneously and momentarily held. The switches are both electrically released to OFF if the monitor circuit signals a failure or the pilot actuates the SAS emergency disengage switch. The switches can also be manually moved to OFF. When either or both switches are OFF, the PITCH SAS caution light will come on. The switches are powered by the right DC bus.

Pitch SAS Caution Light

The PITCH SAS caution light (figure 1-65), on the caution light panel, will come on to indicate that one or both of the pitch SAS channels is disconnected.

Yaw SAS

On 83, the yaw SAS performs three basic functions: ■
 yaw rate damping with $\pm 7^\circ$ rudder authority, yaw trim with $\pm 10^\circ$ rudder authority, and aileron/rudder interconnect (ARI) for turn coordination with $\pm 10^\circ$ rudder authority. SAS rudder authority is limited to $\pm 10^\circ$ below 240 KIAS and $\pm 8^\circ$ above 240 KIAS. The turn coordination command is generated by lateral stick position sensors, and yaw rate gyros.

On 84 (Beta Dot SAS), the yaw SAS performs three basic functions: ■
 yaw rate damping with $\pm 7^\circ$ rudder authority, turn coordination with $\pm 7^\circ$ rudder authority, and yaw trim with $\pm 10^\circ$ rudder authority.

The SAS authority is limited to $\pm 10^\circ$ below 240 KIAS and $\pm 8^\circ$ above 240 KIAS. The sideslip control is generated by the INS or HARS on [62], or HARS on [61], roll rate sensors, angle-of-attack transmitter, and yaw rate sensors.

A monitor circuit senses differential between the left and right channels and shuts off yaw SAS when the differential is excessive. A hydraulic or engine failure will not automatically result in SAS disengagement. However, the affected axes will disengage when a differential between channels is sensed. Rudder pedal authority is more than sufficient to override a SAS induced rudder displacement. Below 240 KIAS, SAS can reduce the maximum obtainable rudder deflection in one direction from $25^\circ - 15^\circ$. Above 240 KIAS, the full 8° of rudder deflection in either direction can always be obtained, regardless of SAS inputs. Flight with a single yaw SAS channel engaged can be safely pursued under most flight conditions once the malfunctioning channel is determined and deactivated. Such flight, however, should be pursued with caution when in formation or when at low altitude due to the possibility of a hardover type failure in the active channel. Such hardover failure will result in the respective rudder being driven a maximum of 10° right or left at speeds below 240 KIAS and 8° at speeds above 240 KIAS if not counteracted by appropriate rudder pedal displacement or SAS emergency disengagement. Single channel yaw SAS operation provides approximately 50% of the yaw trim, damping, and turn coordination available under two-channel operation.

Reengagement of yaw SAS, if desired, following a disengagement should be accomplished with caution, one channel at a time, in straight and level flight at a safe altitude and with sufficient clearance with other aircraft for recovery from possible yaw/roll transients during reengagement. If yaw SAS operation cannot be maintained with both channels engaged and single channel operation is desired for yaw damping, yaw trim, and partial turn coordination, the properly functioning channel can be determined by the trial and error method.

WARNING

- The yaw SAS fail-safe monitoring feature does not function during single channel SAS operation. Close formation or low altitude flight are not recommended during single channel SAS operation due to the

possibility of an undesirable roll/yaw transient in the event of a yaw SAS hardover failure.

- Only one yaw SAS channel should be engaged when only one hydraulic power source or engine is available. The MASTER CAUTION will come on, should a disengagement occur, and this could result in distraction during a critical phase of flight. Additionally, a yaw transient may be experienced at time of disengagement with severity depending upon the amount of yaw SAS input into the rudder actuator.

On [64], if HARS is the operating attitude reference, an uncommanded disengagement will occur in the event of HARS roll or pitch servo failure. This is identified by noting the ADI and HSI power off flags in view and the roll tabs missing from the HUD display, or the HARS caution light coming on with disengagement of yaw SAS. Yaw trim and yaw rate damping can be reenabled by setting the HARS/SAS override switch to OVERRIDE and reengaging the yaw SAS switches.

Yaw SAS Engage Switches

Two yaw SAS engage switches (figure 1-19) are located on the SAS control panel. These are two-position solenoid-held switches, placarded YAW SAS ENGAGE and OFF, with one switch placarded L and the other placarded R. For normal engagement, both switches are actuated simultaneously and momentarily held. The switches are both electrically released to OFF if the monitor circuit signals a failure or the pilot actuates the SAS emergency disengage switch. The switches can also be manually moved to OFF. When either or both switches are OFF, the YAW SAS caution light will come on. The switches are powered by the right DC bus.

HARS/SAS Override Switch [64]

The HARS/SAS override switch (figure 1-65) is located on the auxiliary lighting panel. The switch is a two-position toggle switch, placarded OVERRIDE and NORM. Setting the switch to OVERRIDE eliminates HARS roll inputs to the SAS and provides for yaw SAS reengagement. The HARS/SAS override switch is powered by the right DC bus.

Yaw SAS Caution Light

The YAW SAS caution light (figure 1-65), on the caution light panel, will come on to indicate that one or both of the yaw SAS channels is disconnected.

MANUAL REVERSION FLIGHT CONTROL SYSTEM

The MRFCS is an emergency system for use when dual hydraulic failure is impending or has occurred. The mode is adequate for executing moderate maneuvers and for safe return to base and landing.

Emergency transitions to manual reversion are automatic and instantaneous in pitch and yaw, with stick and pedal commands transmitted directly to the elevator and rudder surfaces through the actuators, which are in the hydraulic bypass mode. Transitions in roll must be pilot initiated. When the pilot selects MAN REVERSION, roll control is transferred from the ailerons to the aileron tabs. Selecting MAN REVERSION also closes hydraulic shutoff valves preventing unexpected return to hydraulic powered flight control. Manual reversion trim is provided only in pitch.

PITCH MRFCS

Pitch transition to manual reversion occurs due to hydraulic pressure depletion. The same components are used for manual and hydraulic pitch control. As hydraulic pressure drops to 600 - 400 psi, elevator control automatically changes from hydraulic to mechanical. Electrical control of the two elevator trim tabs is automatically achieved when both hydraulic power sources have dropped below 1,000 - 800 psi. Artificial feel is retained.

Transition is reversible. Power control of the elevators is instantly restored as pressure at one (or both) of the actuators is increased above 700 - 900 psi. Both elevator trim tabs trim to neutral when either pressure switch senses 1,000 - 1,200 psi.

YAW MRFCS

Yaw transition to manual reversion occurs due to hydraulic pressure depletion. The same mechanical elements are used for manual and hydraulic yaw control. As hydraulic pressure drops to 600 - 400 psi, rudder control automatically changes from hydraulic to mechanical. Transition is reversible. Power control is instantly restored as pressure is increased to 700 - 900 psi.

ROLL MRFCS

To achieve roll control when hydraulic pressure is not present, the flight control mode switch must be set to MAN REVERSION. When MAN REVERSION is selected, stick commands are disconnected from the aileron actuators and connected to the aileron tabs. In this tab drive mode, the aileron tabs fly the aileron surface to the position commanded by the stick. Feel at the stick is proportional to air loads on the tabs.

Aileron Float-Up Transition

After loss of hydraulic pressure, the trailing edges of the ailerons float up to a position that is higher than the powered neutral position. Aileron float-up normally induces an aircraft pitch change which can be nose up or down depending on cg, power setting, and flap position.

To soften pitch onset, the aileron float-up rate is limited by damping in the actuators. The time for the ailerons to float-up after hydraulic pressure loss/ bleed off is approximately 4 seconds. If the flight control mode switch has not been placed in MAN REVERSION after a dual hydraulic failure, the ailerons will float up, the stick will act directly on the actuator linkage and almost no roll control will be available. The stick feel will be the same as experienced on the ground before engine start.

Flight Control Mode Switch

The flight control mode switch (figure 1-18), located on the emergency flight control panel, is placarded FLT CONTR, with positions NORM and MAN REVERSION. The switch is lever-locked in both positions.

In MAN REVERSION both hydraulic systems are shut off. The switch simultaneously drives the aileron/tab shifters to tab drive. All other roll transfer logic is automatic. The switch controls two independent circuits, powered through the L & R AILERON TAB circuit breakers by the DC essential bus.

NOTE

- All flight control mode switch functions are fully reversible at any time, if hydraulic power is available.

Aileron/Tab Shifting Transition

Selecting MAN REVERSION initiates aileron/tab shifting immediately. The shift cycle takes approximately 4 seconds to complete (in either direction). Tab shift action is progressive, providing increasing roll control. As the shifters move from the normal position, switches:

- Deactivate both normal and emergency roll trim
- Drive the roll trim actuators to neutral
- Cause the corresponding L & R AIL TAB caution light to come on.

Driving roll trim to neutral during MRFCS operation assures that the ailerons will go to neutral when hydraulic power is restored.

Aileron Tab Caution Lights

The aileron tab caution lights (figure 1-65), placarded L AIL TAB and R AIL TAB, come on if the corresponding aileron/tab shifter is not at the full normal position.

Aileron/Tab Shifter Malfunctions

Failure to shift to tab drive after the flight control mode switch is placed to MAN REVERSION is indicated by:

- Respective AIL TAB caution light off
- Very high lateral stick force – approaching locked stick feel
- Aileron jam light(s) may be on depending upon stick forces applied
- Stick moves toward the side of the nonfunctioning shifter.

If failure to shift is experienced after switching to MAN REVERSION and hydraulic power is available, return to NORM for the remainder of the flight. Should hydraulic power not be available, some roll control may be achieved by disengaging the aileron for the side with the nonfunctioning aileron/tab shifter.

WARNING

- Flight in manual reversion with one aileron disconnected has not been tested and may be impossible.

Failure of a shifter to return to aileron drive after selecting NORM is indicated by:

- Stick movement toward the side of the malfunctioning shifter
- High lateral stick force required to keep wings level
- Respective AIL TAB caution light remains on when opposite side AIL TAB caution light goes off
- Aileron tab on side with nonfunctioning shifter responds to stick movement with aileron remaining in neutral position
- Aileron trim inoperative.

If failure to shift is experienced after shifting to NORM, roll control can be increased, if necessary, by disengaging the aileron for the side with the nonfunctioning aileron/tab shifter as indicated by the AIL TAB caution light.

With one side disengaged, maximum roll capability will be reduced approximately 50%, and stick input for a given roll will be twice normal.

Roll trim can be restored by pulling the AIL TAB circuit breaker for the side with the nonfunctioning shifter. The corresponding AIL TAB caution light will go off when this circuit breaker is pulled and both ailerons will respond to roll trim.

Failure to complete the shift to tab or aileron drive degrades roll control for the mode selected. The degree of control available is based upon the amount of shift accomplished prior to failure. Hydraulic pressure and neutral aileron position will be normal for the mode selected. The aileron tab caution lights should provide an indication of which shifter has malfunctioned unless an AIL TAB circuit breaker has opened. If an AIL TAB circuit breaker is open, the associated caution light is inoperative. The aileron tab circuit breaker should be checked whenever a shifter failure is suspected.

MRFCS OPERATION

Shifting to MRFCS Mode (Hydraulic Power Available)

Most conversions to MRFCS will be intentionally initiated. If intentional transition is planned, the

MRFCS should be ground checked prior to flight. Reasons to transfer to MRFCS, while hydraulic power is still available, include the following:

- Training in the MRFCS mode
- Checkout of the MRFCS mode
- Precautionary transfer to MRFCS mode; e.g. one hydraulic system failed and failure of the second system is imminent.

When accomplishing an intentional shift into manual reversion, comply with operating limitations in Section V. Selecting MAN REVERSION simulates a dual hydraulic failure, while simultaneously initiating roll transition to manual reversion. When the flight control mode switch is placed to MAN REVERSION, the following events occur:

- Hydraulic supply pressure is shut off and bleeds off to zero psi. This can take up to 10 seconds. Bleed off can be observed on the cockpit hydraulic pressure gauges and by noting the L/R HYD PRESS caution lights
- The aileron tabs initiate (on switch actuation) shift to tab drive and this is indicated by the L/R AIL TAB caution lights coming on. Complete shift can take up to 4 seconds.

When hydraulic supply pressure bleed off is complete, aileron float up begins. Float up will take up to 4 seconds. Once the ailerons are floated up, the aileron actuators are in a bypass mode. Since supply pressure bleed off and aileron float up are sequential, the total time to regain roll control after selecting MAN REVERSION can be up to 14 seconds. If the stick is moved laterally prior to completion of aileron float up, the ailerons may float up abruptly and asymmetrically.



- Failure of one or both hydraulic systems to drop below 250 psi after switching to MAN REVERSION may result in locked ailerons after shift to aileron tab drive commences. Under these circumstances, control stick feel will be near normal for manual reversion; however, roll capability will be slight and in the opposite direction to stick displacement. Therefore, should

one or both hydraulic pressure gauges fail to drop below 250 psi within approximately 10 seconds and, if roll is in opposite direction to stick displacement, return the switch to NORM.

NOTE

- The L/R AIL or L/R ELEV jam indicator lights may come on during manual reversion, due to airloads.

Shifting to MRFCS Mode (Hydraulic Power Not Available)

In a dual hydraulic failure the stick will essentially lock in roll. Stick feel will be the same as experienced on the ground before engine start. Pitch and yaw control will be available immediately, but the pilot must select MAN REVERSION to initiate tab shifting which will make it possible to regain roll control. Roll control will be available in approximately 4 seconds after selecting MAN REVERSION.

If hydraulic failure occurs, when operating single engine or with an asymmetric loading, the aircraft will begin a slow roll into the dead engine or heavy wing. The pilot should retard the throttle on the operating engine (to IDLE if conditions permit) after selecting MAN REVERSION. Coordinate rudder and aileron as thrust is increased after transition is complete. Asymmetric loadings can be corrected by selective jettison, as conditions permit.

Shifting Back to PFCS Mode

Hydraulic power, if available, is immediately applied to flight control actuators when the flight control mode switch is returned to NORM. All logic functions are fully reversible and powered control of the elevators and rudders is immediate. Pitch trim change may be required.

The ailerons drive down to neutral trim position, but roll control is not fully effective until aileron/tab shifting is complete. Roll trim control, both normal and emergency, is available at the completion of the shifting operation. Yaw trim control is regained after YAW SAS is reengaged.

SECONDARY FLIGHT CONTROL SYSTEM

FLAP SYSTEM

The aircraft is equipped with four wing trailing edge flaps (figure 1-20). Flap positions are 0° (UP), 7° (MVR), and 20° (DN). The flaps are individually supported and each flap is positioned by one hydraulic actuator. The flaps are powered by the left hydraulic system. A cockpit control lever controls the flaps. When extended, flaps hold position in the event of loss of flap system electrical and/or hydraulic power until commanded up by the flap emergency retract switch. On loss of the left hydraulic system, the flaps will be inoperative. When fully extended, aerodynamic forces will cause unpowered flaps to retract to less than 15° and maneuvering flaps to retract to 0° if the emergency flap switch is activated. In full UP or DN, hydraulic pressure is retained in the selected position to eliminate flap creeping. During ground operations with the flap control set to MVR, the flaps may creep. The left outboard flap will cycle about the 7° position, and the other flap panels may assume varying positions. It may be necessary to recycle the flap lever to get all panels back to the 7° position.

Flaps will not extend and will automatically retract if the airspeed exceeds 185 - 210 KIAS. The flap control must be recycled through UP position, after the airspeed is below approximately 180 KIAS, in order to extend the flaps. On [81], when aircraft speed is reduced below approximately 190 KIAS (5-15 KIAS below auto retract speed), the flaps will automatically reextend if the flap lever is in MVR or DN. Emergency flap retract capability is provided by an emergency flap switch on the emergency flight control panel. When activated, the switch shuts off pressure and opens the down lines to return. Aerodynamic forces drive the flaps up to a minimum position.

Flap Lever

The flap lever (figure 1-4) is located on the throttle quadrant. It is placarded FLAPS with positions designated UP, MVR and DN. The lever electrically directs left hydraulic pressure to the flap actuators. The UP position fully retracts the flaps and retains hydraulic pressure to maintain flaps up. Selection of MVR positions the flaps to 7°. The DN position drives the flaps to full extended and retains hydraulic pressure to maintain flaps down. In the MVR position all but the left hand outboard flap can creep but

should retain symmetry under airloads. The flap lever has a lever lock which must be lifted when moving the lever from MVR to DN. The flap lever is powered by the right DC bus.

Flap Emergency Retract Switch

The flap emergency retract switch (figure 1-18) is a two-position lever-locked switch, located on the emergency flight control panel, placarded FLAP EMER RETR. The switch is powered by DC essential bus. The FLAP EMER RETR switch allows aerodynamic blow back of the flaps if flaps fail to retract due to failure of normal valving, control circuitry, or hydraulic system.

CAUTION

- The overspeed protection circuit "Q switch sensor" is inoperative with the emergency flap switch in EMER RETR. Aerodynamic blow back may not fully retract the flaps in this position. Flap extension speeds are noted in Section V.

Flap Position Indicator

The flap position indicator (34, figure FO-1), on the instrument panel, is placarded FLAPS DEGREES. The indicator is powered by the auxiliary DC essential bus and receives its position signal from the position control unit attached to the LH outboard flap.

SLAT SYSTEM

The slat system (figure 1-21) consists of movable two-position slat panels which are mounted on the inboard leading edge section of each wing. Slats are powered by the right hydraulic system. Electrical power for control is from the right DC bus.

The slats function automatically to improve high AOA air flow to the engines. The ESPS detects conditions that will lead to engine stall. Stall is determined in the ESPS system as a function of AOA and Mach. The AOA is measured by a lift transducer mounted on the lower side of the left wing leading edge. Mach is measured internally in the ESPS through the pitot static system. At a predetermined AOA and Mach, the slats extend. Slat actuation parameters are shown in figure 6-2. The ESPS is powered by the right AC bus.

WING FLAP SYSTEM SCHEMATIC

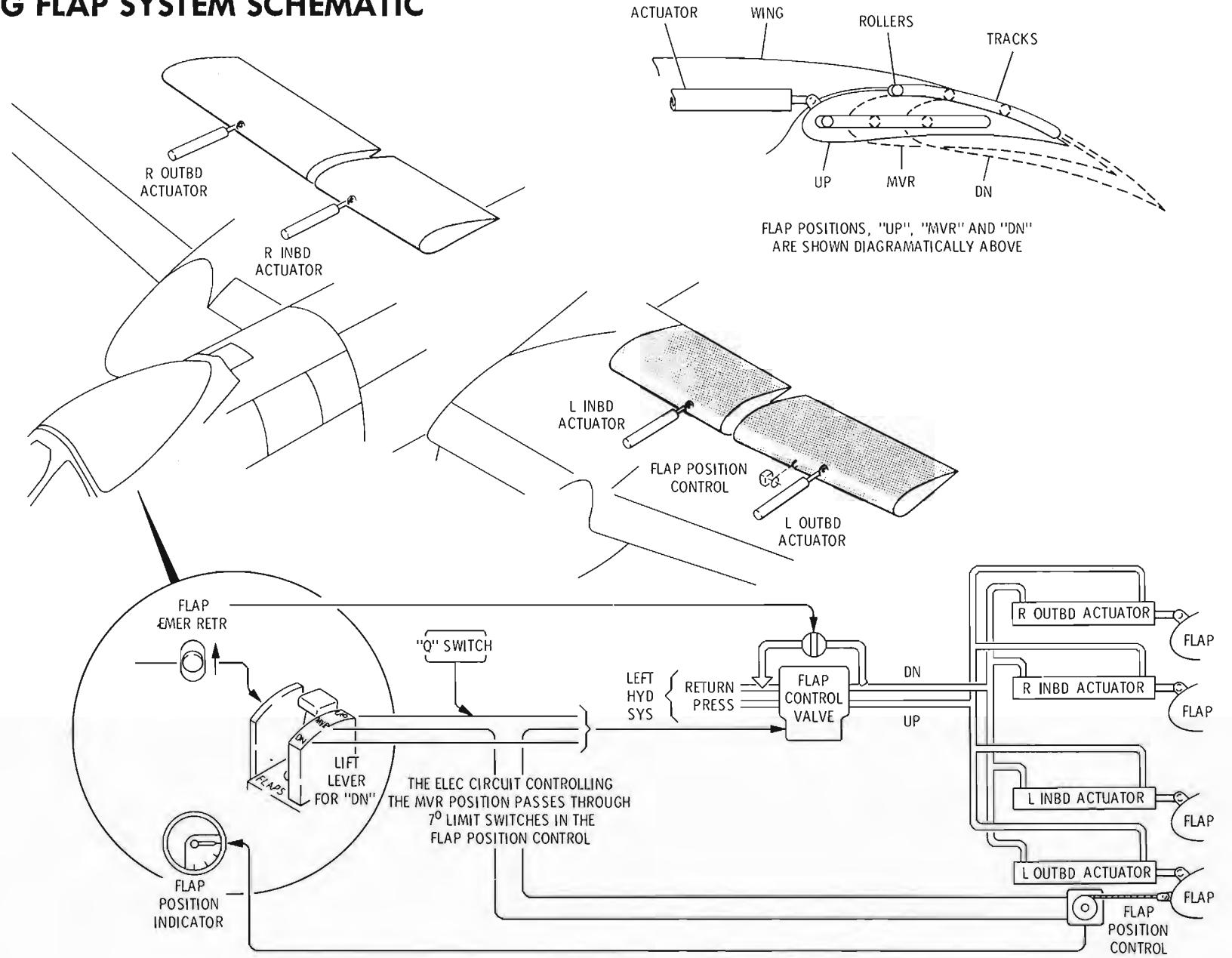

Figure 1-20

WING SLAT SYSTEM SCHEMATIC

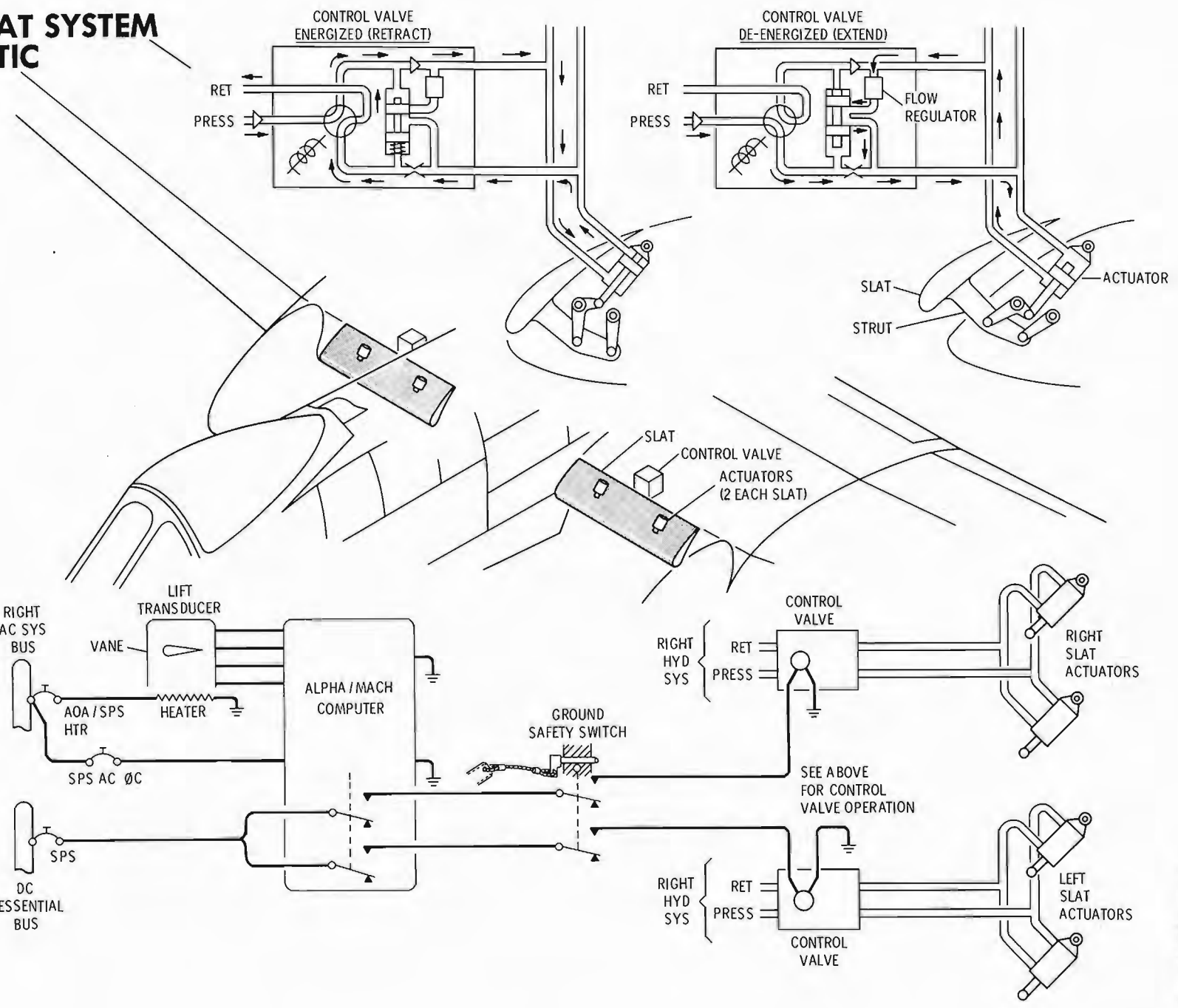

Figure 1-21

The lift transducer and its sensing vane are protected from icing by a heating element, which is energized when the pitot heat switch is set to HEAT. The heating element is powered by the right AC bus.

CAUTION

- If the pitot heat switch is OFF, or fails during flight or the lift transducer vane heater fails, the slats may not extend when required.

On loss of either AC or DC electric power, the hydraulic system will extend the slats for fail-safe protection of the engines. On loss of hydraulic power, airloads will automatically extend the slats. With the slats extended, a drag index increase of 2.0 will result. Upon engine shutdown, slats may or may not extend.

WARNING

- During ground operations, slats could cycle rapidly with application or removal of aircraft electrical power. Use caution to avoid injury to ground personnel.

SPEED BRAKE SYSTEM

The speed brake surfaces (figure 1-22) and actuating mechanisms are integrated in the ailerons. The upper and lower surfaces of both ailerons open to act as speed brakes.

The speed brakes fully open or close in approximately 3 seconds. On the ground, opening time is slightly less and closing time is slightly more. A limit switch limits the speed brakes to the 80% position during flight, and precludes holding positions of less than 10%. The squat switch on the left main landing gear allows 100% deployment on the ground. If the aircraft becomes airborne with a speed brake position exceeding 80%, the speed brakes will not automatically retract to 80%. In this condition the speed brakes will only respond to retract commands initiated by the speed brake switch.

Automatic pitch trim compensation is provided by pitch SAS for speed brake deployment.

Automatic overspeed structural protection is provided by means of hydraulic relief action. The speed brakes

blow back proportionally as air loads approach structural limits. Similarly, speed brake extend rate and travel is limited at high speed.

With total loss of hydraulic power (right engine not rotating), aerodynamic forces will slowly close speed brakes to trail position. With right engine windmilling and if commanded prior to engine failure, speed brakes will be held in position. If commanded after engine failure and engine is windmilling, partial extension (degree dependent on airspeed) can be expected. Closing speedbrake switch or selecting SPD BK EMER RETR will allow speed brakes to retract as hydraulic pressure is depleted.

With loss of electrical power, the speed brakes will retract to the closed position hydraulically.

Speed Brake Switch

The speed brake switch is located on the right throttle grip, and has three positions. The aft position extends the speed brakes, and the switch is spring-loaded to the center or hold position. The forward position is detented and retracts the speed brakes. Moving or releasing the switch to the center position will hold the speed brakes in any position permitted by the system limits. The switch is powered by the auxiliary DC essential bus.

Speed Brake Emergency Retract Switch

The speed brake emergency retract switch (figure 1-18), placarded SPD BK EMER RETR, is located on the emergency flight control panel. It is a lever-locked, two-position switch. When the switch is in the normal (unmarked) position, the speed brakes are controlled by the speed brake control. When the switch is set to SPD BK EMER RETR, normal control circuits are deactivated and a direct emergency circuit blocks hydraulic pressure and vents speed brake extend lines to return. This action allows air loads to completely close the brakes. The switch circuitry is independently powered by the auxiliary DC essential bus.

BOARDING LADDER

The boarding ladder (figure 1-23) is a telescoping ladder that stows in a compartment in the left forward fuselage, below the cockpit. The ladder compartment door is hinged on the forward edge and opens to rest flat against the fuselage. A permanent-type magnet holds the door in the open position. A

battery bus-powered latch mechanism is located at the aft edge of the door. Both the compartment door and the ladder are spring-loaded to open, and the ladder telescopes open by gravity. From the cockpit,

the ladder may be extended by pressing a pushbutton switch (4, figure FO-3) located under a hinged cover guard placarded EXTEND BOARDING LADDER.

SPEED BRAKE SYSTEM SCHEMATIC

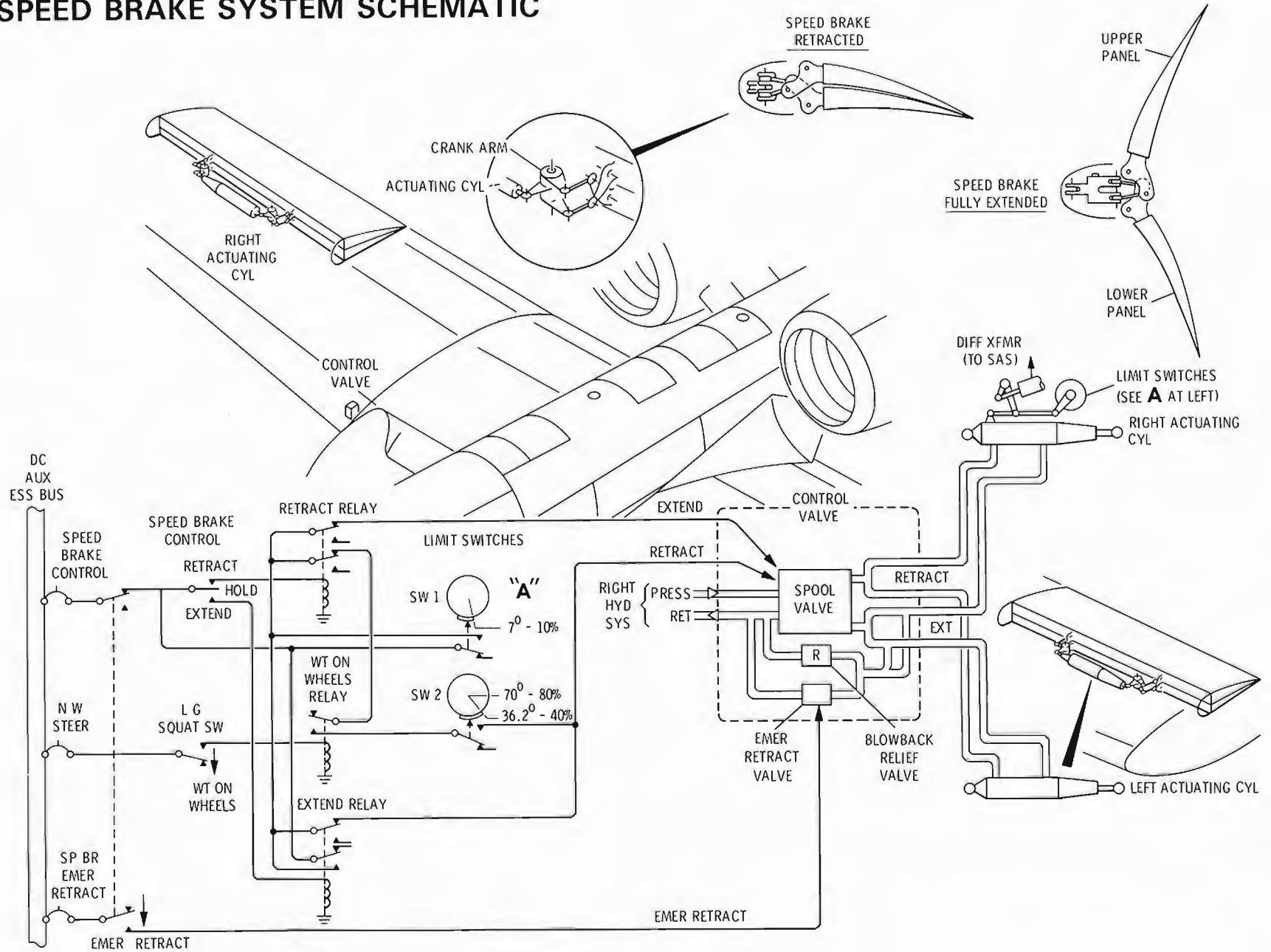
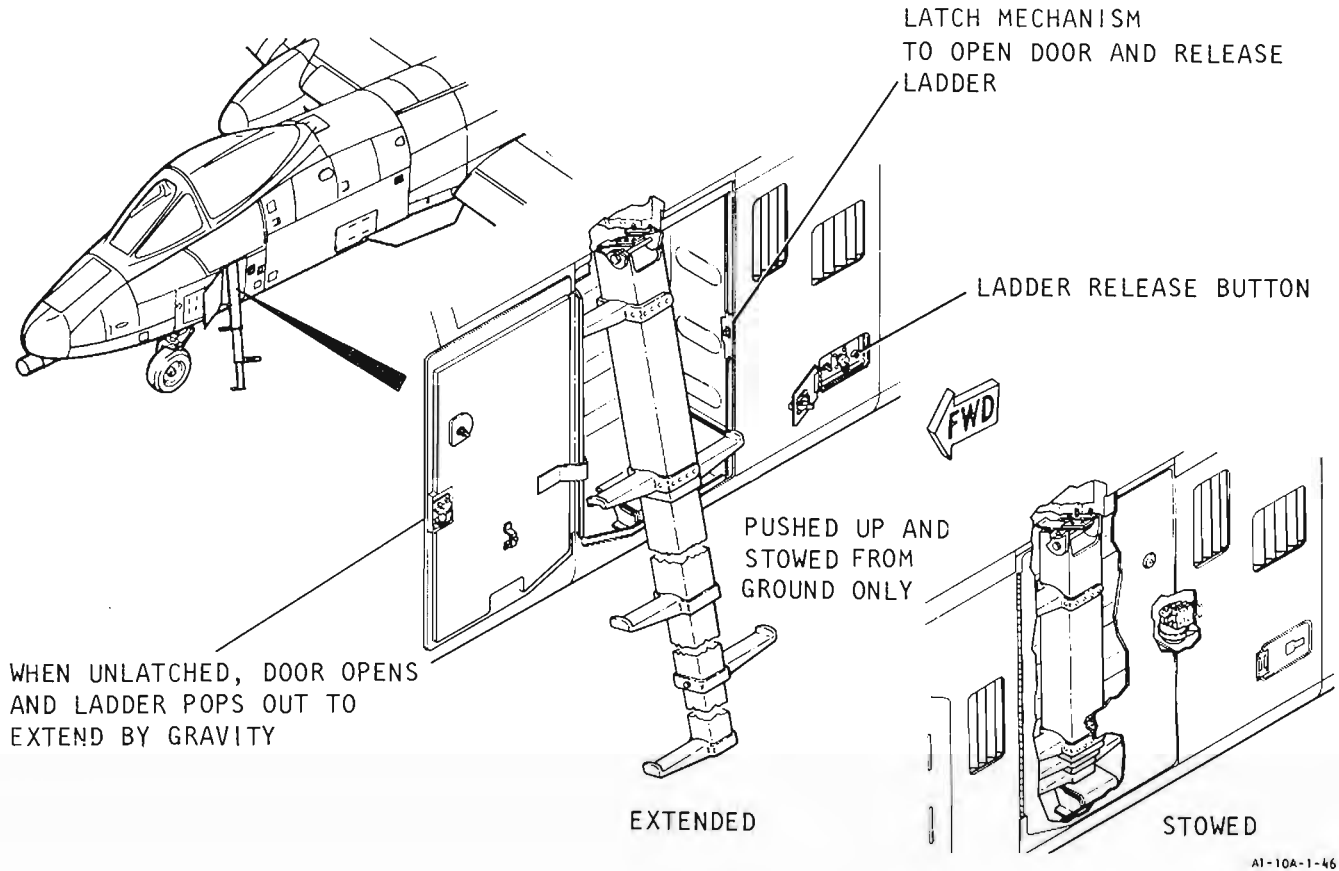

Figure 1-22

1-132-1-45

BOARDING LADDER



AI-10A-1-46

Figure 1-23

From the exterior of the aircraft, the ladder may be extended by pressing a switch located aft of the door. For stowage, the ladder must be pushed up manually.

WARNING

CANOPY

The canopy is constructed of molded stretched acrylic plastic, with no supporting structural members.

Normal raising or lowering of the canopy is accomplished by control switches, from inside or outside the aircraft (figure 1-24). The canopy is opened and closed by an actuator that operates on battery bus power.

- A malfunction in the canopy control circuitry could cause the canopy to immediately begin closing after reaching the full up position. If this occurs, place **CANOPY** switch to **HOLD** and stay clear. Once the canopy is fully closed, exit from the aircraft can be accomplished by manually raising the canopy.

CANOPY CONTROLS

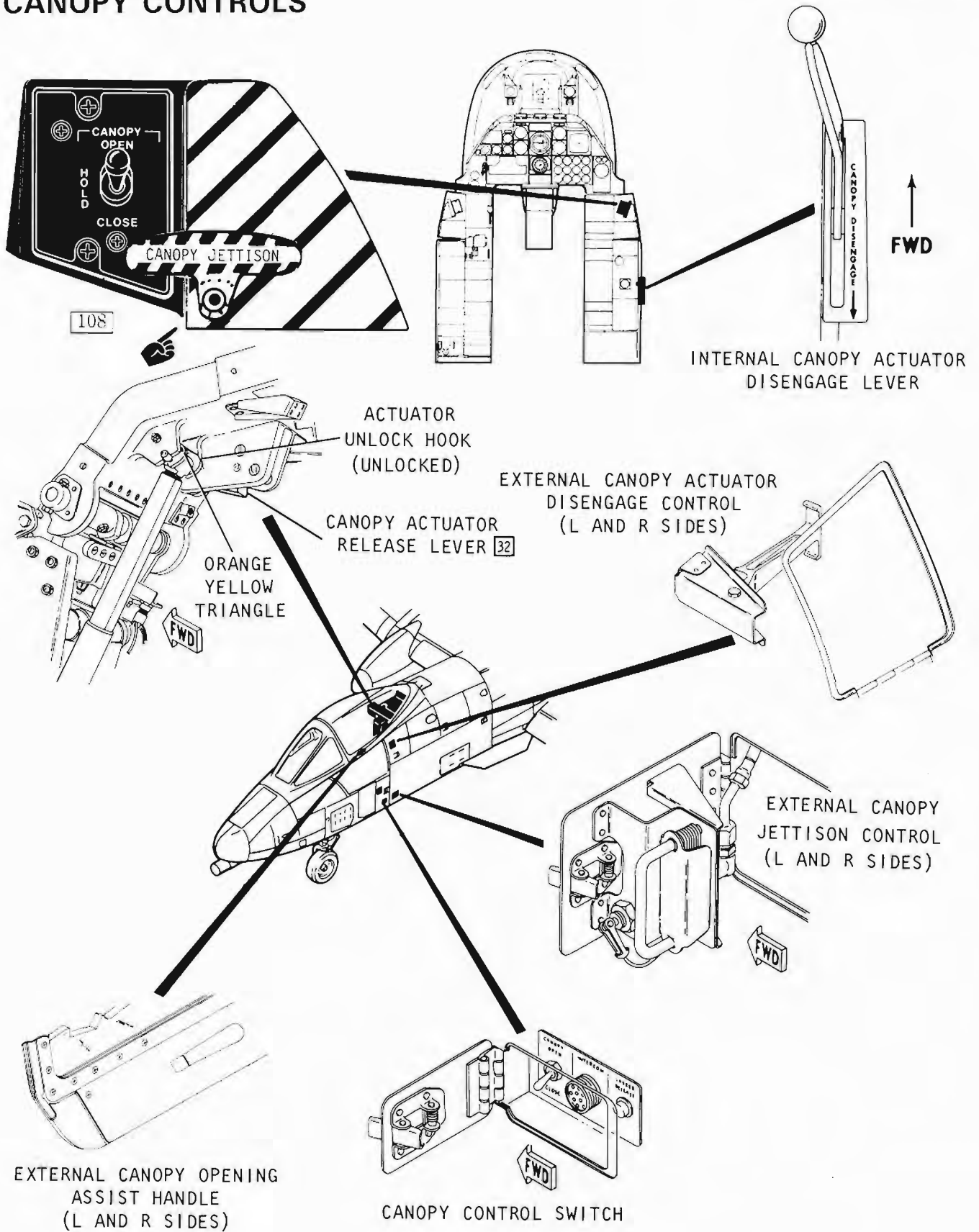
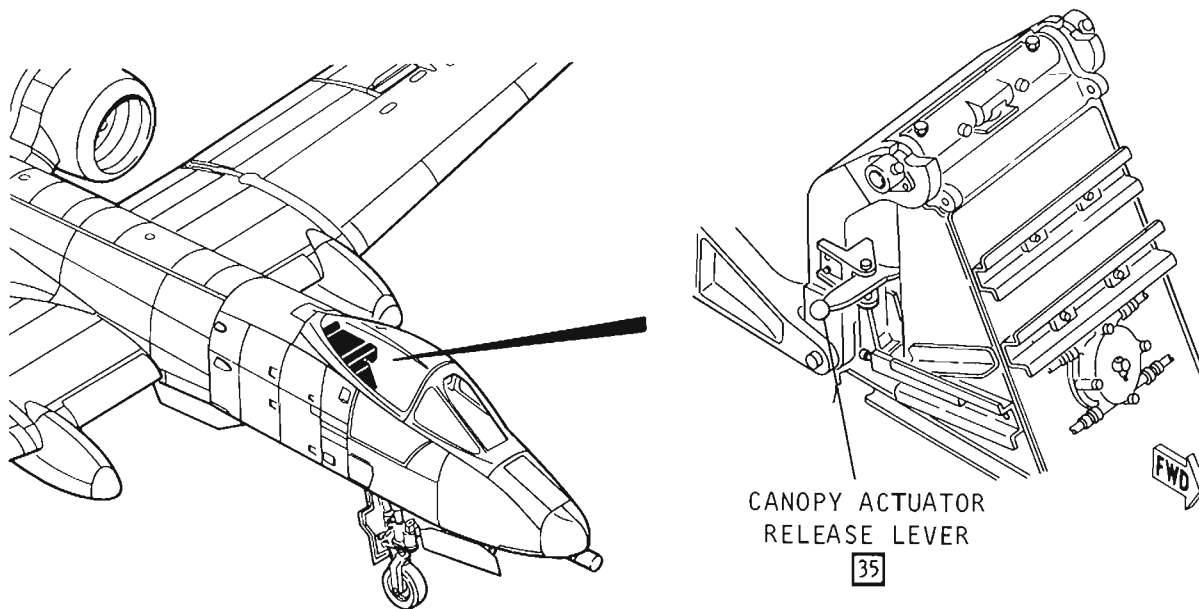

Figure I-24. (Sheet 1 of 2)

CANOPY CONTROLS (CONT)



A 1-10A-1-25

Figure 1-24. (Sheet 2 of 2)

In the event of failure of the actuator or loss of battery bus power, provisions for mechanical disengagement of the canopy/actuator attachment are available. Disengagement is accomplished by three mechanical control devices enabling the pilot or ground crew to open the canopy manually from the inside or outside (left or right side) of the aircraft.

The canopy may be jettisoned, either in flight or on the ground, independent of the seat ejection function, by pulling a control, placarded **CANOPY JETT**, located on the right console. The canopy may be jettisoned from the outside by a control on either side of the aircraft which is independent of the seat ejection function. The canopy jettison sequence is initiated by opening either rescue door, and pulling the handle approximately 6 feet.

COCKPIT CANOPY CONTROL SWITCH

The cockpit canopy control switch (figure 1-24), placarded **CANOPY**, is a three-position toggle switch located on the right console placarded **OPEN**, **HOLD**, and **CLOSE**. When the switch is lifted and set to **OPEN**, battery bus power unlocks the canopy

and the actuator drives the canopy to full open. When in **HOLD**, the canopy will stop movement and remain at the desired position. When the switch is held in **CLOSE**, the actuator is electrically driven to the fully locked position. The switch is spring-loaded to return from **CLOSE** to **HOLD** when released. The switch will remain in **OPEN**.

NOTE

- After the canopy switch is positioned to **OPEN**, it may take up to 3 seconds for the canopy seal to depressurize and the canopy locks to open before the canopy starts to move.

CANOPY UNLOCKED LIGHT

A red warning light (16, figure FO-1), placarded **CANOPY UNLOCKED**, is located on the instrument panel. The light indicates the canopy is not closed and locked. The light is powered by the auxiliary DC essential bus.

EXTERNAL CANOPY CONTROL SWITCH

The external canopy control switch (figure 1-24) is located at the lower left side of the aircraft beneath the canopy. The switch is placarded CANOPY with two momentary positions OPEN and CLOSE and spring-loaded to a center unmarked OFF position. To close the canopy with the external switch, insure the cockpit canopy control switch is in HOLD to preclude the canopy from opening when the external switch is released. The switch is powered by the battery bus.

INTERNAL CANOPY ACTUATOR DISENGAGE LEVER

The internal canopy actuator-disengage lever (figure 1-24), placarded CANOPY DISENGAGE, is located on the outboard side of the right console. To disengage the canopy actuator, the canopy must be closed and the lever moved aft, as indicated by a placarded arrow. Moving the lever aft releases the canopy downlock mechanism, unlocks the canopy, and disengages the canopy actuator. When it is unlocked and disengaged, the canopy is free to slide aft about one inch, and open manually. The canopy is held in the full-open position by a spring-loaded uplock pin.

If the canopy is partially open and the actuator cannot be disengaged by use of the canopy actuator disengage lever:

- On [32] the pilot can disengage the actuator by unstrapping, reaching behind the seat on the aircraft right side, and pushing up on the canopy actuator release lever
- On [35] the pilot can disengage the actuator by reaching behind the seat on the right side and pulling forward on the canopy actuator release lever.

If the canopy must be opened manually while the engines or APU are running:

- The APU should be shut down and the bleed air switch positioned to OFF or the main air supply switch should be positioned to OFF on [22] prior to opening the canopy. Either action will depressurize the canopy seal and allow the actuator disengage lever to be moved aft with less effort.

INTERNAL EMERGENCY CANOPY ACTUATOR RELEASE LEVER

The internal emergency canopy actuator release lever is located above and aft of the ejection seat (figure 1-24). On [32], the emergency canopy actuator release lever (trigger) is provided to manually disengage the canopy actuator downlock/unlock hooks from the canopy actuator if the canopy jams during normal operation. On [35], the emergency canopy actuator release lever, extending toward the right side of the fuselage, is pulled forward to displace the canopy downlock mechanism to unlock the canopy and disengage the canopy actuator. The handle is colored flat black with a yellow knob on the outboard end.

INTERNAL MANUAL CANOPY OPENING ASSIST HANDLES

The internal manual canopy opening assist handles (4, figure FO-2 and 10, figure FO-3), are placarded MANUAL CANOPY OPENING ASSIST. Each handle is retained in a stowed position by a spring-loaded pin. Each handle is manually rotated in an inward and upward direction to a horizontal position. Grasping the handles with both hands and sliding the canopy aft and up opens the canopy manually, after the canopy has been disengaged.

INTERNAL CANOPY JETTISON HANDLE

The internal canopy jettison handle (figure 1-24), placarded CANOPY JETT superimposed on a striped background, is located in the extreme forward panel of the right console. The handle is linked by a shaft directly to the canopy initiator. The jettison sequence is begun by pulling the canopy jettison handle.

CANOPY BREAKER TOOL

The canopy breaker tool (13, figure FO-3) is a special knife with a short blade, located on the right canopy rail.

EXTERNAL CANOPY ACTUATOR DISENGAGE CONTROLS

The external canopy actuator disengage controls (figure 1-24) are T-shaped handles installed on the left and right sides of the fuselage and accessible by opening an access door. When either T-handle is rotated with the canopy closed, the canopy is unlocked and the canopy actuator is disengaged.

EXTERNAL CANOPY OPENING ASSIST HANDLES

The external canopy opening assist handles (figure 1-24) are flush mounted foldout handles located at the left and right sides of the canopy frame approximately 6 inches aft of the bow. Rotating the handles upward and grasping facilitates raising the canopy manually.

EXTERNAL CANOPY JETTISON CONTROLS

The external canopy jettison controls (figure 1-24) are located in compartments located on either side of the fuselage, behind access doors placarded **RESCUE**. Both left and right doors are accessible from the ground. Inside the compartments are handles that are linked by 6-foot long lanyards to canopy initiators.

EJECTION SEAT

The ACES II ejection seat is a fully automatic catapult rocket system (figure 1-25). Three ejection modes are automatically selected. Mode 1 is a low speed mode during which the parachute is deployed almost immediately after the seat departs the aircraft. Mode 2 is a high speed mode during which a drogue chute is first deployed to slow the seat, followed by the deployment of the parachute. Mode 3 is a high altitude mode in which the sequence of events is the same as Mode 2, except that man-seat separation and deployment of the parachute is delayed until a safe altitude is reached. Controls are provided to adjust seat height and lock shoulder harness.

BATTERY INDICATOR

A battery indicator (figure 1-25), a small circular hole on the right side of the seat forward of the seat rail, gives indication of the status of the seat sequencing system battery. White indicates a good battery; red indicated bad.

EMERGENCY OXYGEN

An emergency oxygen supply is contained in a cylinder located on the left side of the seat. The hose is routed to a connector on the torso harness. The system is actuated automatically in an ejection by a lanyard anchored to the cockpit structure. a green ring is located on the left side of the seat bucket for in-cockpit use.

INERTIA REEL POWER HAUL-BACK

The seat system incorporates a powered inertia reel retraction mechanism. The inertia lock reel mechanism automatically restrains the pilot against the seat backrest as a preejection function.

MANUAL INERTIA REEL CONTROL

The manual inertia reel control is placarded **SHOULDER HARNESS** with positions **UNLOCKED** (aft) and **LOCKED** (forward). The **LOCKED** position locks the inertia reel at any increment of shoulder harness extension. The **UNLOCKED** position unlocks the shoulder harness inertia reel. The reel automatically locks if subjected to an inertia load of more than 2.0 g's. If the inertia reel has automatically locked, the inertia reel control must be cycled to release the reel.

SEAT GROUND SAFETY LEVER

A seat ground safety lever is located behind the left side ejection control handle. When the lever is in the **SAFE** position (forward), the ejection controls are locked. During flight, the seat ground safety lever must be in armed position (aft) to ensure that the handles are unlocked. A safety pin can be inserted to lock the controls.

107 SEAT NOT ARMED LIGHT

The **SEAT NOT ARMED** light on the annunciator panel will illuminate with the seat ground safety lever in the **SAFE** (forward) position. The light will go out when the lever is in the **ARMED** (aft) position.

EJECTION HANDLES

The ejection control handles, mounted on each side of the seat bucket, placarded **PULL TO EJECT**, are actuated by an upward and aft pull of approximately 45 pounds, and lock in the extended position.

The handles are interconnected so that actuation of either handle initiates the ejection sequence. The hand opening in each handle is covered on the inboard side by a flexible safety guard.

SEAT ADJUSTMENT SWITCH

The seat adjustment switch is placarded SEAT and has three positions: UP, DOWN, and HOLD. Seat height is selected by holding the switch in UP or DOWN until the desired height is obtained. The seat adjustment motor is protected by a thermal relay that will disconnect when overheated. After a 1-minute cooling period, the motor should operate normally. The switch, spring-loaded to return to the center HOLD position when released from either UP or DOWN positions, is powered by the left AC bus.

CAUTION

- Seat adjustment with disconnected personal leads or strap-in connections lodged between the seat and console may result in damage to the seat, console, and/or leads/connections.

105 SEAWATER ACTIVATED RELEASE SYSTEM (SEAWARS). The SEAWARS consists of two parachute harness sensing-release units (figure 1-25); one fitted to each parachute riser. When the water sensor is immersed in seawater, the parachute riser is released from the canopy release, freeing the pilot from the parachute.

SEAT

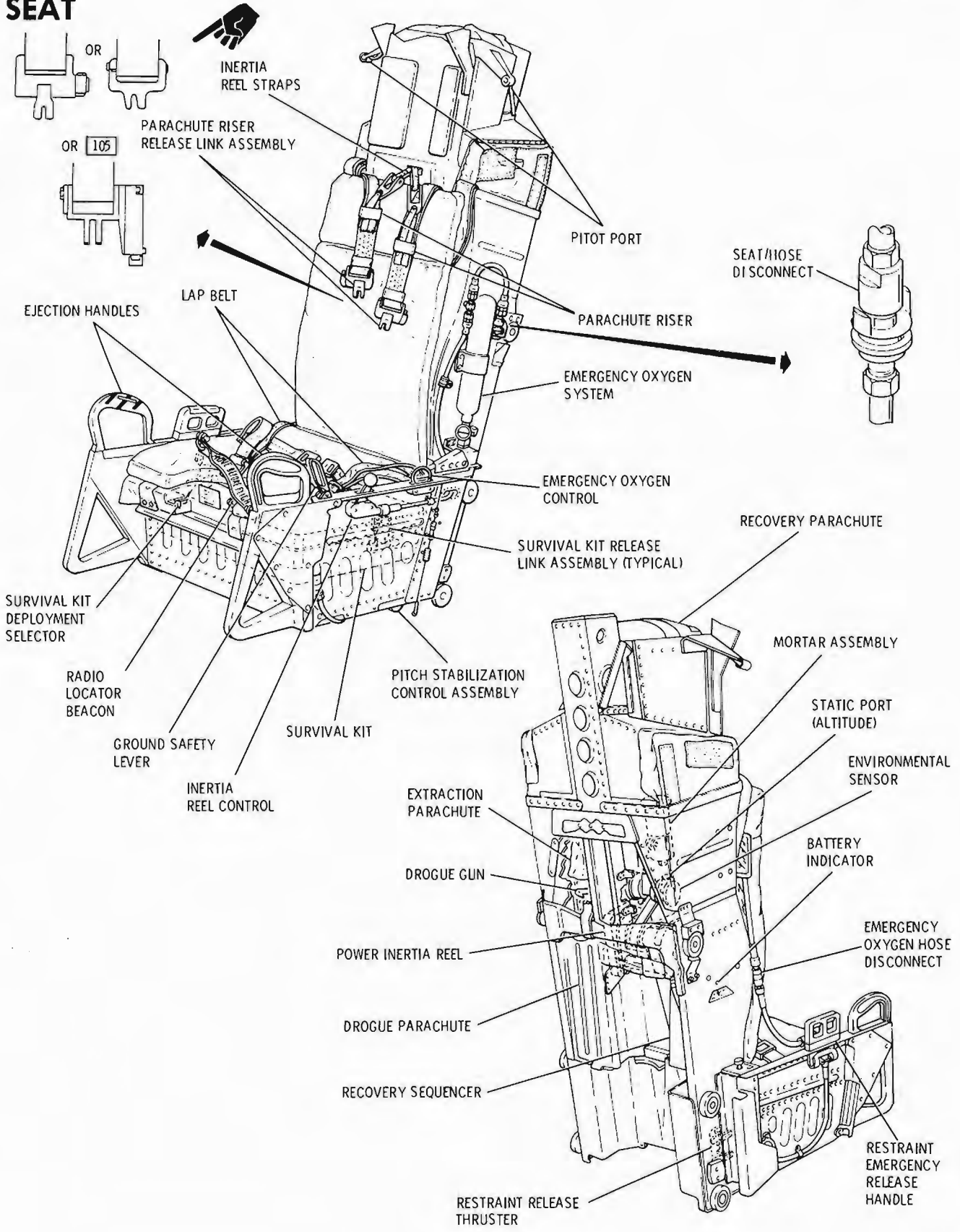

Figure 1-25

81-10A-1-21

SURVIVAL KIT

The ACES II ejection seat provides for stowage of a nonrigid equipment package in the seat bucket, covered by a rigid, contoured seat pan.

The survival kit (figure 1-26) consists of a fabric case that houses the liferaft, a rucksack, and a small inner container for the stowage of survival equipment. A radio locator beacon is installed on the outside of the kit. Two adjustable straps secure the kit to the pilot's torso harness by means of quick-release connectors.

SURVIVAL KIT DEPLOYMENT SELECTOR

A kit deployment selector, located in the right side forward edge of the seat pan, allows the pilot to preselect automatic or manual deployment of the rucksack and liferaft. When automatic deployment is selected, the kit closures are released by a 4-second delay cutter that is armed at seat-pilot separation. This allows the rucksack and liferaft to drop on a 25-foot lanyard. The pilot can manually deploy the rucksack and liferaft during descent by pulling the manual release ring. The inner container is secured to the kit case, and does not deploy.

RADIO LOCATOR BEACON

The radio locator beacon is activated and its antenna is deployed automatically at seat/pilot separation. A control switch is provided in the left side, forward edge of the seat pan, to permit the pilot to override the automatic operation of this beacon.

RESTRAINT EMERGENCY RELEASE HANDLE

The restraint emergency release handle is placarded **RESTRAINT EMERGENCY RELEASE**. To activate the release system, the handle must be unlocked, by squeezing the trigger and pulling up approximately 6 inches with about a 40-pound pull.

Pulling the handle releases the lap belt and inertia reel straps, unlocks the seat pan, pulls the pin on the pilot chute, and releases the recovery parachute from the mortar assembly. The pilot will still be attached to the parachute risers and survival kit. On 75, pulling the handle while the seat is installed in the cockpit will also disconnect the survival kit from the harness by ballistically releasing the attachment straps from the kit. If, during an ejection, the automatic recovery sequence is not completed, the restraint

emergency release handle may be activated to manually deploy the recovery parachute and simultaneously disconnect the pilot from the seat.

SEAT OPERATION—EJECTION SEQUENCE

WARNING

- Do not attempt to eject with the canopy open, since the canopy will not jettison and the bow structure will obstruct the escape clearance envelope.

1. Escape begins by grasping and pulling either or both ejection handles in an up and aftward direction. Actuation fires a cartridge, generating gas pressure that activates the haulback inertia reel and fires other cartridge-actuated components for immediate jettisoning of the canopy and activation of an aircraft-mounted delay initiator. The gas pressure also closes a switch activating the aircraft emergency IFF system.

2. The forward structural bow of the canopy clears the ejection path in approximately 0.2 second.

NOTE

- In the event the canopy fails to jettison, the canopy breaker at the top of the seat will shatter the canopy and an ejection can take place.

3. The delay initiator fires 0.3 second after activation, causing a cartridge in the rocket catapult to fire, projecting the seat upward. During the upward travel, the pilot's personal leads separate, the seat/airplane gas disconnect separates, and a lanyard actuates the emergency oxygen cylinder. Also, the acceleration forces cause the pilot's legs to be held

SURVIVAL KIT

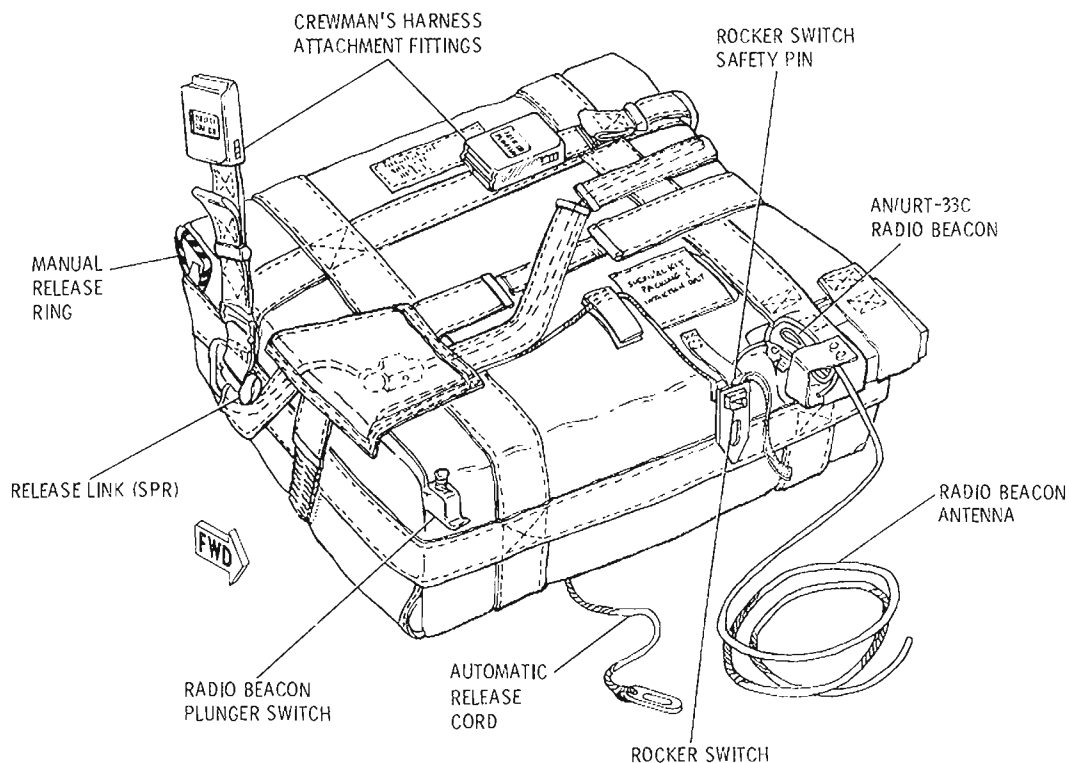

AI-10A-1-9

Figure 1-26

within the sides of the seat bucket due to the raised ejection controls. Catapult pressure activates two thermal batteries, providing electrical power for the recovery sequencer.

4. As the seat moves up the guide rails, the pitot tubes at each side of the headrest (parachute container) are exposed to the airstream. Speed and altitude transducers determine the airspeed and altitude of the seat. The recovery sequencer selects the appropriate automatic sequence.

5. As the seat approaches the top of the guide rails:

a. The rocket motor ignites.

b. Recovery sequencer is initiated by a switch that closes on contact with a striker plate on the right guide rail.

c. An electrical signal from the sequencer fires a cartridge, generating pressure to spin up a pitch rate gyro.

d. Upon reaching its operating speed, the gyro is uncaged and the pitch stabilization vernier rocket motor ignites.

e. As the seat leaves the guide rails, the rocket motor accelerates the seat away from the aircraft in a suitable trajectory.

f. The gyro controlled vernier rocket motor stabilizes the seat in its trajectory. Leg flailing due to windblast is prevented by the high extended sides of the seat bucket with the raised ejection controls, which also aids in maintaining seat stability.

The remainder of the recovery sequence depends upon the recovery mode. The envelopes relating to each mode of operation are shown in figure 3-7. The recovery sequence for each mode is as follows:

- Mode 1 Operation (figure 3-6)

In Mode 1, the recovery parachute mortar is fired 0.2 second after rocket catapult ignition. As the mortar propels the parachute assembly away from the seat, 1.15-second delay reefing line cutters are activated and the pilot chute is released. The harness release thruster is actuated 0.25 seconds later and the deploying parachute separates the pilot from the seat. The parachute inflates to the reefed configuration until the reefing line cutters actuate to permit full inflation. The survival kit is automatically deployed approximately 4.0 seconds after seat/man separation (if automatic survival kit deployment is selected). In addition, if the locator beacon rocker switch is in the automatic position, the beacon will be activated at this time.

- Mode 2 Operation (figure 3-6)

In Mode 2, the drogue gun is initiated as the seat approaches the top of the guide rails. Projection of the drogue gun slug deploys the extraction chute which in turn deploys the drogue chute. The drogue chute provides seat retardation and additional stabilization for high speed ejections. The recovery parachute mortar is fired 0.82 second after rocket catapult ignition, and 0.15 seconds later the drogue chute is severed from the seat. Parachute operation, seat/man separation, etc., occur thereafter as in Mode 1.

- Mode 3 Operation

In Mode 3, the operation and sequence of events is identical to that for Mode 2 (figure 3-6), except that after the drogue

chute is deployed, the sequence is interrupted until the altitude and speed decrease to Mode 2 conditions (figure 3-7).

BACK-UP RECOVERY MODE OPERATION

In the event of a failure of the automatic recovery system after ejection, operation of RESTRAINT EMERGENCY RELEASE will mechanically operate the harness release mechanism. This handle also disconnects the parachute assembly from the seat and releases the pilot chute for deployment of the recovery parachute. Operation of the survival kit attachment release system, installed on 75, is disabled when the seat is out of the aircraft.

OXYGEN SYSTEM

The oxygen system is a liquid oxygen type consisting of a converter, a quantity gauge, external filler valve, and a regulator. A regulator supplies the pilot with breathing oxygen. Oxygen duration at various altitudes is shown in figure 1-27.

OXYGEN REGULATOR

The oxygen regulator (figure 1-28), installed on the right console, is an automatic diluter-demand type. In normal use, as the altitude increases, the amount of air in the mixture decreases until 100% oxygen is delivered to the mask at 30,000 feet cabin altitude. Pure oxygen (100%) can be delivered at all altitudes at pilot's option.

Supply Lever

The supply lever (figure 1-28), placarded SUPPLY, is a green colored two-position toggle control. The positions are placarded ON and OFF. In ON position, gaseous oxygen flows from the oxygen regulator. Setting the regulator to OFF shuts off oxygen flow at the regulator.

Diluter Lever

The diluter lever (figure 1-28), is a white colored two-position toggle, located on the oxygen regulator control panel. The two positions are placarded 100% OXYGEN and NORMAL OXYGEN. In NORMAL OXYGEN, the oxygen regulator provides the optimum air/oxygen mixture for a particular altitude, in the quantity demanded by the pilot. In 100% OXYGEN, pure oxygen is provided regardless of altitude.

OXYGEN DURATION – HOURS											
<div style="display: flex; justify-content: space-between; align-items: center;"> ← with diluter lever "100%" → with diluter lever "normal" * </div>											
CABIN ALTITUDE FEET	INDICATED QUANTITY – LITERS										BELOW 0.5
	5.0	4.5	4.0	3.5	3.0	2.5	2.0	1.5	1.0	0.5	
35,000 & above	30.94	27.84	24.75	21.65	18.56	15.47	12.37	9.28	6.19	3.09	DESCEND TO ALTITUDE NOT REQUIRING OXYGEN
	—	—	—	—	—	—	—	—	—	—	
30,000	30.94	27.84	24.75	21.65	18.56	15.47	12.37	9.28	6.19	3.09	
	22.63	20.37	18.11	15.84	13.58	11.32	9.05	6.79	4.53	2.26	
25,000	—	—	—	—	—	—	—	—	—	—	
	22.99	20.70	18.40	16.10	13.80	11.50	9.20	6.90	4.60	2.30	
20,000	17.48	15.73	13.98	12.24	10.49	8.74	6.99	5.24	3.50	1.75	
	—	—	—	—	—	—	—	—	—	—	
15,000	21.72	19.55	17.37	15.20	13.03	10.86	8.69	6.52	4.34	2.17	
	13.19	11.87	10.55	9.23	7.91	6.60	5.28	3.96	2.64	1.32	
10,000	—	—	—	—	—	—	—	—	—	—	
	24.43	21.99	19.55	17.10	14.66	12.22	9.77	7.33	4.89	2.44	
5,000	10.62	9.56	8.49	7.43	6.37	5.31	4.25	3.19	2.12	1.06	
	—	—	—	—	—	—	—	—	—	—	
SL	29.86	26.88	23.89	20.90	17.92	14.93	11.94	8.96	5.97	2.99	
	8.53	7.68	6.83	5.97	5.12	4.27	3.41	2.56	1.71	0.85	
SL	—	—	—	—	—	—	—	—	—	—	
	29.85	26.88	23.89	20.90	17.92	14.93	11.94	8.96	5.97	2.99	
SL	6.75	6.08	5.40	4.73	4.05	3.38	2.70	2.03	1.35	0.68	
	—	—	—	—	—	—	—	—	—	—	
SL	29.86	26.88	23.89	20.90	17.92	14.93	11.94	8.96	5.97	2.99	
	5.46	4.92	4.37	3.82	3.28	2.73	2.19	1.64	1.09	0.55	
SL	—	—	—	—	—	—	—	—	—	—	
	29.86	26.88	23.89	20.90	17.92	14.93	11.94	8.96	5.97	2.99	

*Using CRU-73/A Diluter-Demand Regulator

Figure 1-27

Emergency Lever

The emergency lever (figure 1-28), is a red colored three-position toggle, located on the oxygen regulator panel. The three positions are placarded EMERGENCY, NORMAL, and TEST MASK. In EMERGENCY, a constant flow of oxygen is delivered to the oxygen mask under pressure. In NORMAL, the proper oxygen-air mixture is available on demand. In TEST MASK, in which the toggle must be held, since it is spring-loaded to NORMAL, oxygen is delivered under pressure to test the oxygen mask for leaks and proper fit.

Oxygen Flow Indicator

The oxygen flow indicator (figure 1-28), is an oblong-shaped display located in the upper left corner of the oxygen regulator control panel, placarded FLOW. The indicator blinks alternately white and black with each inhalation/exhalation cycle to signify the flow of oxygen.

Oxygen Supply Pressure Indicator

The oxygen supply pressure indicator (figure 1-28), placarded OXYGEN SUPPLY PRESSURE, displays the gaseous oxygen pressure in the oxygen supply line.

OXYGEN SYSTEM REGULATOR AND QUANTITY GAUGE

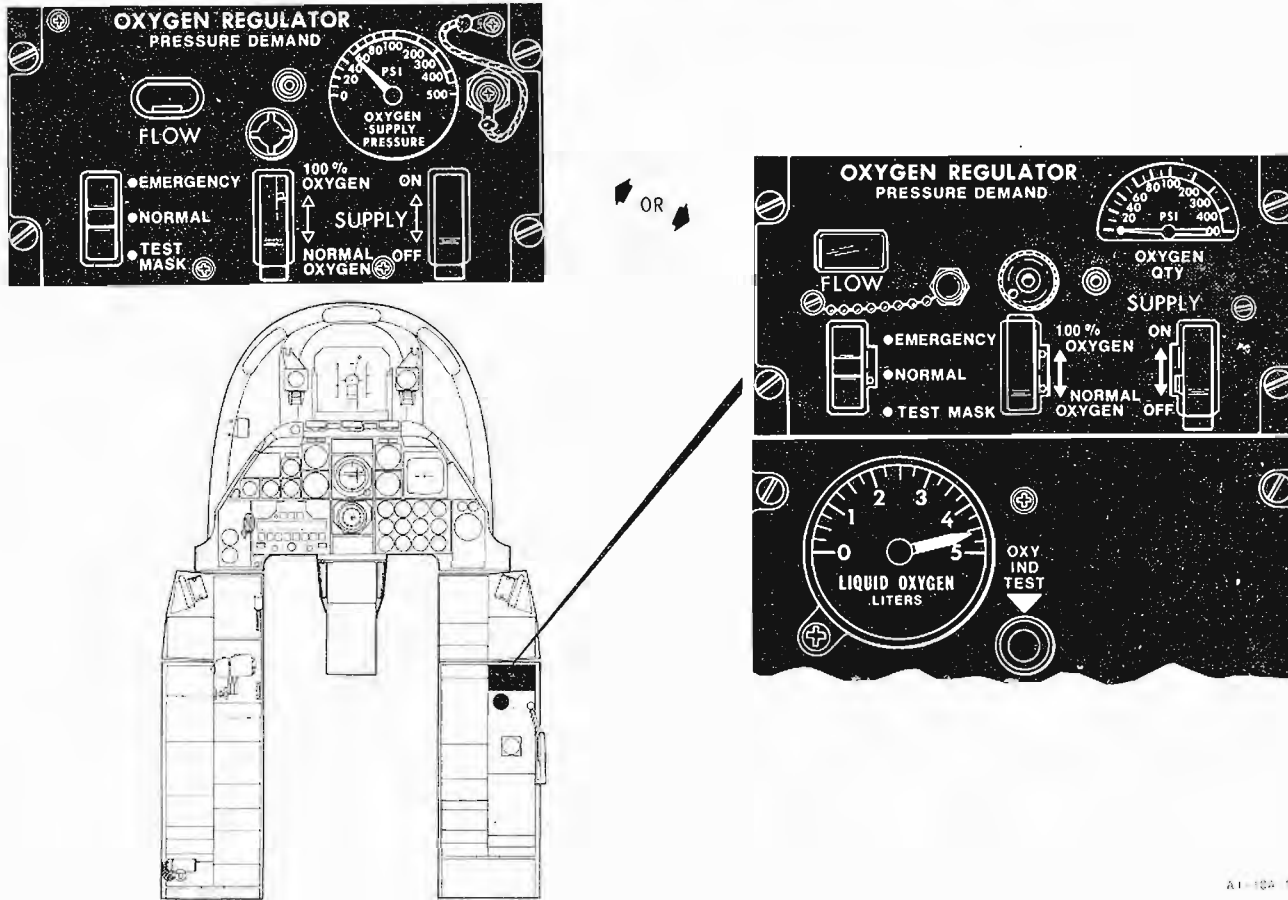

Figure 1-28

OXYGEN INDICATOR TEST BUTTON

The oxygen indicator test button (figure 1-28), placarded OXY IND TEST, is a pushbutton switch located on the environment control panel. When the button is pressed and held, the liquid oxygen quantity indicator moves toward 0 and at the 0.5 liter indication triggers the oxygen low level caution light. When the button is released, the liquid oxygen indicator displays actual oxygen quantity.

OXYGEN QUANTITY INDICATOR

The liquid oxygen quantity indicator (figure 1-28), mounted on the environment control panel in the right console, is placarded LIQUID OXYGEN-LITERS. The indicator scale ranges from 0 - 5 liters. The indicator shows the quantity of liquid oxygen in the converter. The indicator uses power from the auxiliary AC essential bus.

OXYGEN LOW-LEVEL CAUTION LIGHT

The liquid oxygen low-level caution light (figure 1-65), placarded OXY LOW, is located on the caution light panel. The OXY LOW light and the MASTER CAUTION light come on when the liquid oxygen quantity gauge indicates 0.5 liter or less.

ENVIRONMENT SYSTEM

The environment system (figure 1-29) supplies temperature-controlled air for cockpit air conditioning and pressurization. The system also provides service air for windshield and canopy defogging, windshield rain removal, canopy seal, anti-G suit pressurization, and external tank pressurization. The environment system receives bleed air from the APU, external source, or from the engines. The airflow rate to the cockpit is controlled by means of the flow

level control on the environment control panel. The temperature controller automatically maintains the selected mixed airflow temperature level. If the environment system becomes inoperative, the cockpit can be ventilated by ram air.

Cockpit pressurization is ensured by use of a canopy seal system and a cockpit air pressure regulator. Cockpit pressurization (figure 1-29) is automatically initiated at 10,000 feet and is controlled by the cockpit air pressure regulator. Regulator discharge air assists in cooling equipment in the electronic and avionics compartments. If the regulator fails, a cockpit air pressure safety valve automatically opens. The safety valve may also be operated manually by selecting DUMP on the TEMP/PRESS switch. Cockpit pressurization is powered by the auxiliary DC essential bus. Cockpit altitude is monitored by the cockpit pressure altimeter on the environment control panel.

On [62], cooling air for the INU is supplied by a blower from cabin discharge air. When cabin discharge air is above 90°F, cabin supply air is provided to the blower if the ECS is operating. Therefore, on the ground in warm weather (above 75°F), the ECS and APU should be operated to provide adequate INU and blower cooling.

The INU will automatically shut down before it is damaged by overheat. If INU shutdown occurs, the CDU mode selector switch should be turned OFF to remove power from the blower.

INU AIR HOT CAUTION LIGHT [62]

The INU AIR HOT caution light (figure 1-65), is located on the caution light panel, and works in conjunction with an overtemperature switch that monitors cooling air temperature into the INU. The INU AIR HOT caution light will come on when cooling air temperature is inadequate for INU and blower cooling.

MAIN AIR SUPPLY SWITCH

The main air supply switch (figure 1-30), placarded MAIN AIR SUPPLY, located on the environment control panel, is a two-position toggle switch used to provide alternate closure of ECS valve which shuts off engine bleed air to Environment Control System but does not shut off ram air. The placarded positions are SUPPLY and OFF. The switch must be raised to move it from the SUPPLY position. The switch is powered by the battery bus. See figure 1-31 for main air supply switch positions versus temperature/pressure control switch positions.

WARNING

- The main air supply switch is for emergency use only. The temperature pressure control should be positioned to RAM when normal shutoff of air conditioning is desired.
- Whenever the main air supply or bleed air controls (APU and bleed air switch) are OFF, the pilot should select 100% oxygen because air may not be entering cockpit.

NOTE

- When MAIN AIR SUPPLY switch is OFF, the 65 PSI valve (ECS shutoff valve) is closed and all bleed air to environment system is cut off.

SERVICE AIR HOT CAUTION LIGHT

The SERVICE AIR HOT caution light (figure 1-65), is located on the caution light panel, and works in conjunction with an overtemperature switch that continuously monitors precooler air output temperature. If the precooler output air temperature is excessive, the SERVICE AIR HOT caution light will come on. Any obstruction of the ram air duct, ejector nozzle, or precooler will cause an overtemperature condition.

TEMPERATURE/PRESSURE CONTROL SWITCH

The temperature/pressure control switch (figure 1-30), placarded TEMP/PRESS, is a three-position toggle switch, located on the environment control panel. The switch positions are placarded NORM, DUMP, and RAM. NORM and DUMP are powered by the auxiliary DC essential bus; the RAM position is powered by the battery bus. See figure 1-31 for temperature/pressure control switch positions versus main air supply switch positions.

COCKPIT PRESSURE ALTIMETER

The cockpit pressure altitude indicator (figure 1-30), placarded CABIN PRESS ALT X 1000, is located in the center of the environment control panel. The altimeter operates on a self-contained aneroid mechanism.

All data on page 1-60, including figure 1-29 sheet 1, deleted.

Figure 1-29. (Sheet 2 of 4) Deleted.

ENVIRONMENT SYSTEM SCHEMATIC

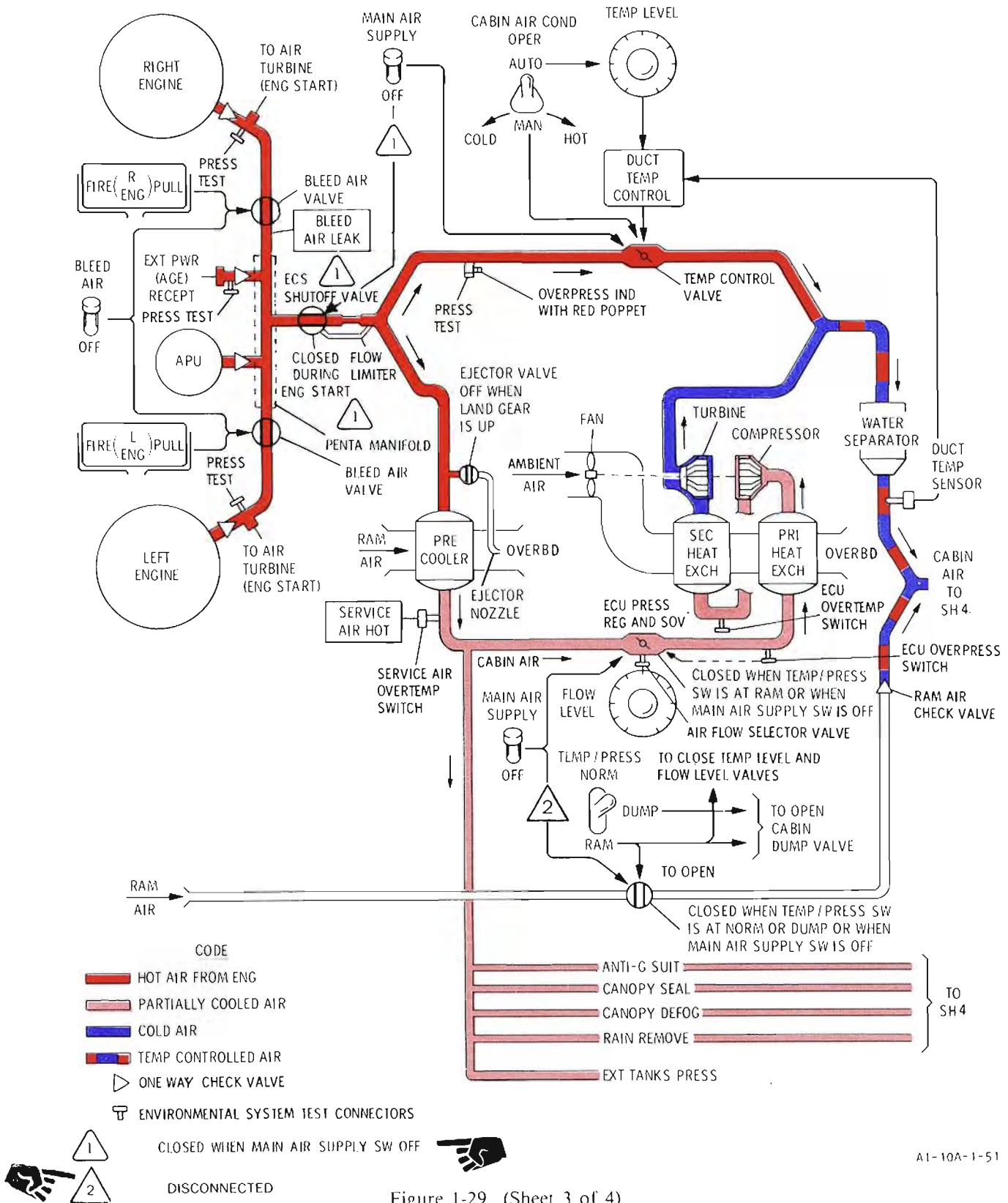

ENVIRONMENT SYSTEM SCHEMATIC (CONT)

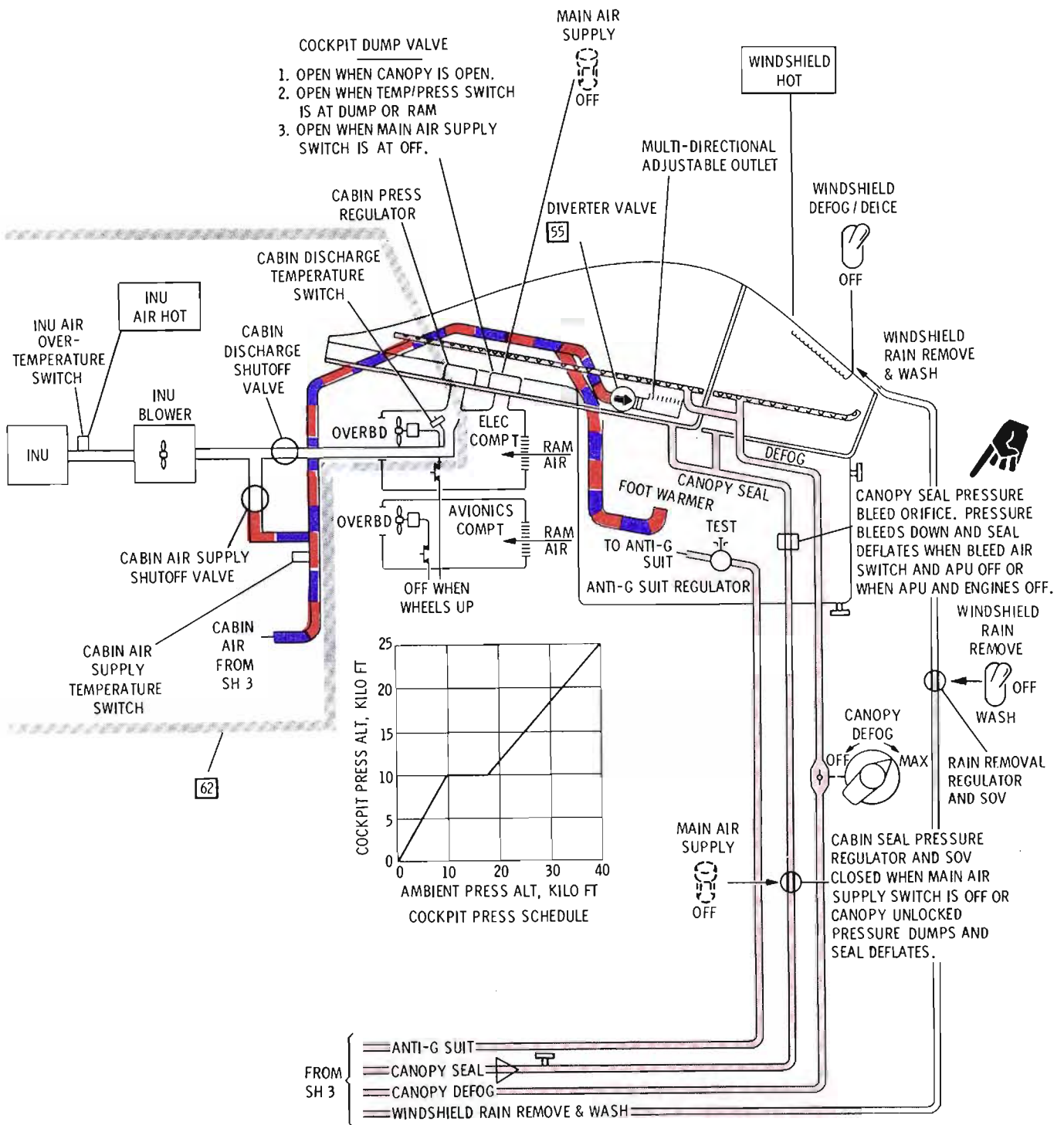

B1-10A-1-23

Figure 1-29. (Sheet 4 of 4)

ENVIRONMENT CONTROL PANEL

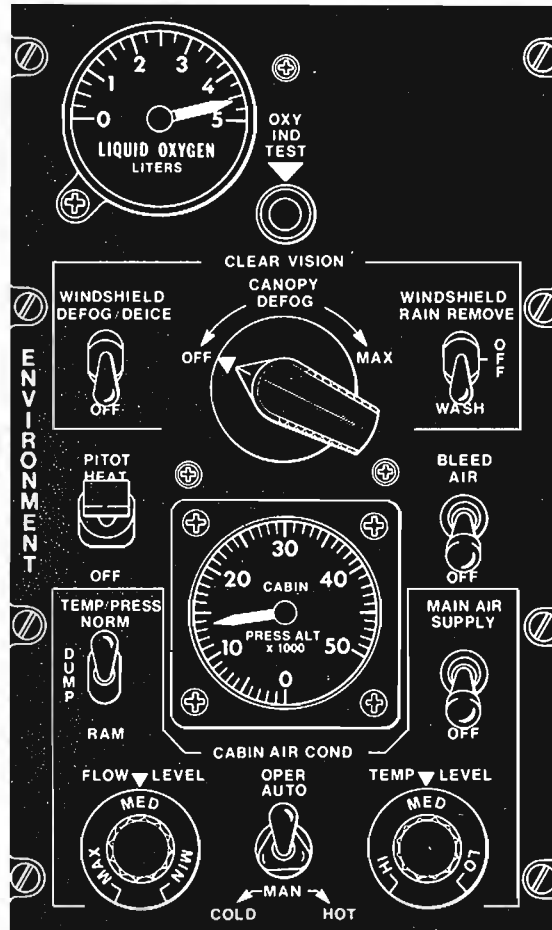
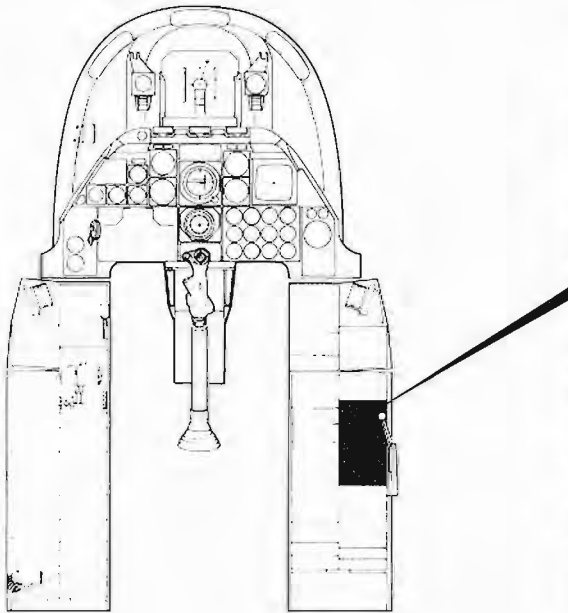

1-10A-1-52

Figure 1-30

AIR CONDITIONER CONTROL SWITCH

The air conditioner control switch (figure 1-30), placarded **CABIN AIR COND OPER**, is located on the environment control panel. The control switch provides a selection of either automatic or manual control of the air conditioning system. In **AUTO**, air conditioning temperature is automatically regulated by the temperature level rotary switch. In **MAN**, the conditioned air temperature is selected by the pilot by holding the switch in **COLD** or **HOT**. It will take approximately 30 seconds for the temperature valve to cycle from full **COLD** to full **HOT** or vice versa. The switch is powered by the auxiliary DC essential bus.

CAUTION

- Manual operation in full **HOT** can cause undetectable ECS overheating if the main air supply switch is **OFF**. Do not select

manual **HOT** without checking that the main air supply switch is in **SUPPLY** and insure there is ECS airflow to the cockpit.

NOTE

- When operating in **MAN**, the temperature and airflow to the cockpit will increase if engine throttle setting is increased. Reestablish desired temperature by holding switch toward **COLD**. Select **MAN** only if automatic control is inoperative.
- To prevent overshooting the desired temperature level in the cockpit, when operating the air conditioner control in **MAN**, it is recommended that a short pulse be used followed by a waiting period to determine the amount of temperature increase or decrease.

TEMPERATURE/PRESSURE CONTROL POSITION VERSUS MAIN AIR SUPPLY SWITCH POSITION

TEMP/PRESS (POSITION)	MAIN AIR SUPPLY - SUPPLY	MAIN AIR SUPPLY - OFF
NORM	Air cond - On Cabin press - On Canopy seal - Inflated Cabin ram air - Off	Air cond - Off Cabin press - Dump Canopy seal - Deflated Ram air - Off
DUMP	Air cond - On Cabin press - Dump Canopy seal - Inflated Cabin ram air - Off	Air cond - Off Cabin press - Dump Canopy seal - Deflated Ram air - Off
RAM	Air cond - Off Cabin press - Dump Canopy seal - Inflated Cabin ram air - On	Air cond - Off Cabin press - Dump Canopy seal - Deflated Ram air - On

NOTE

- The above operation holds true whether the air conditioner switch is in AUTO or MAN, assuming bleed air is available to ECS, and canopy closed.

Figure 1-31

FLOW LEVEL CONTROL

The flow level control (figure 1-30), placarded FLOW LEVEL, is a manually operated rotary control, located on the environment control panel. The flow level control is used to control the amount of conditioned air flowing into the cockpit. The rotary portion of the control is placarded MIN, MED, and MAX but any desired intermediate flow may be selected.

TEMPERATURE LEVEL CONTROL

The temperature level control (figure 1-30), placarded TEMP LEVEL, is a rotary switch located on the environment control panel that is active when the cabin air control switch is in AUTO. The temperature level control permits selection of any desired conditioned air temperature setting. The rotary portion of the control is placarded LO, MED, and HI but any desired intermediate temperature may be selected. The switch is powered by the auxiliary DC essential bus.

DIVERTER VALVES 55

To improve the flow of warm air to the pilot's feet, a manually operated diverter valve is installed in each of the upper cabin air conditioning ducts (figure 1-29). The diverter valve can be positioned from full open to 10% open with intermediate detented positions. Closing the diverter valves forces warm air to the foot area outlets and decreases airflow from the cabin air outlets. Minimum foot warming is obtained when the flow arrow on the diverter valve is horizontal. Maximum foot warming is obtained when the flow arrow is perpendicular to the flow.

CANOPY DEFOG SYSTEM

Defogging of the canopy and windshield panels is accomplished by defog tubes, which discharge precooled engine bleed air.

CANOPY DEFOG CONTROL

The canopy defog control (figure 1-30), placarded **CANOPY DEFOG**, is a rotary control located on the environment control panel. It is used to manually control the amount of precooled engine bleed air flowing through the defog tubes along the base of the canopy. The control positions are placarded **OFF** and **MAX**, with arrows indicating direction of rotation. The control should be used during descents to provide maximum windshield antifog protection.

WINDSHIELD DEFOG/DEICE SYSTEM

The center windshield panel interior surface is deiced and defogged by heat from an element embedded near the outer surface of the windshield center panel. The windshield heater is controlled by the windshield defog/deice switch.

WINDSHIELD DEFOG/DEICE SWITCH

The windshield defog/deice switch (figure 1-30), placarded **WINDSHIELD DEFOG/DEICE**, located on the environment control panel, is a two-position toggle switch used to control the electrically heated deicing circuit in the windshield. In **DEFOG/DEICE**, left AC system bus power energizes the element embedded in the windshield. Placing the switch in **OFF** deactivates the system. **The DEFOG/DEICE position shall be selected anytime windshield fogging or icing conditions are suspected during flight.**

WINDSHIELD HOT CAUTION LIGHT

The **WINDSHIELD HOT** caution light (figure 1-65), located on the caution light panel, is actuated by a temperature sensor on the windshield center panel. The light will come on when the windshield temperature is in excess of 150°F, whether caused internally by system malfunction or externally by leaving the rain removal system on for an extended period. The light will also come on to indicate a malfunction in the windshield deicing circuit, a system power failure, or if the battery is the sole source of electrical power. If the cause is due to an overtemperature condition, continued use can result in windshield cracking.

WINDSHIELD RAIN REMOVAL SYSTEM

For ground operation and to aid inflight rain removal when flying at low speed, an air jet blast, utilizing precooled bleed air, provides rain removal over the windshield center panel. The electrically-operated shutoff valve is controlled by the rain removal switch.

WINDSHIELD WASH SYSTEM 19

A wash system for removing gun gas residue from the windshield and side panels is provided. A three-gallon wash solution tank is located in the forward portion of the nose wheelwell. Approximately one half gallon of solution is used during each wash cycle. The rain removal nozzle includes a wash solution nozzle. The system is controlled by the rain removal/windshield wash switch.

WARNING

- The windshield wash system should not be used anytime forward vision is essential since forward vision is obscured during the wash cycle.

RAIN REMOVAL/WINDSHIELD WASH SWITCH

The rain removal/windshield wash switch (figure 1-30), is a three-position switch placarded **RAIN REMOVE**, **OFF**, and **WASH**. When positioned to **RAIN REMOVE**, an airjet blast of engine bleed air from the precooler is directed to facilitate rain

removal of the windshield. The switch is spring-loaded from WASH to OFF. Momentarily positioning the switch to WASH activates the circuit for 30 seconds (wash 6 seconds and purge 24 seconds). On [16], the switch is a two-position switch, placarded RAIN REMOVE and OFF, and the wash solution is not provided. The switch is powered by the left DC bus.

ANTI-G GARMENT SYSTEM

The anti-g garment system (figure 1-29), consists of a pressure regulating valve which supplies air to the garment upon accelerations of 1.75 g or greater. A test button (20, figure FO-2) is provided to simulate operation under g loading.

FLIGHT INSTRUMENTS

PITOT-STATIC SYSTEM

The pitot-static system consists of a pitot-static probe, located in a boom on the leading edge of the right wing. The probe supplies impact air pressure to the airspeed indicator and "Q" sensors. Static pressure is supplied to the airspeed indicator, "Q" sensors, altitude computer on [61], the CADC on [62], and the VVI.

The pitot-static system functions automatically. However, the pitot-static probe contains a heating device controlled by a switch in the cockpit.

Pitot Heater Switch

The pitot heater switch (figure 1-30), placarded PITOT HEAT and OFF, is located on the environment control panel. HEAT supplies power from the left AC bus to the pitot heater and total temperature probe and power from the right AC bus to the AOA vane heater and the lift transducer vane.

Central Air Data Computer [62]

The CADC receives inputs of static and pitot pressure from the pitot static system, total temperature from the total temperature probe, and barometric pressure from the altimeter (see figure 1-32). The inputs are used by the CADC to provide electrical outputs to aircraft systems. The CADC operates in two modes, normal and self-test. The normal mode is

automatic. Inputs are processed and converted as appropriate, to analog or digital data. Systems receiving CADC outputs include the INS, HUD, altimeter, IFF, and caution light panel. During normal operation the CADC continuously monitors its performance. If a malfunction occurs, the CADC caution light on the caution light panel comes on, airspeed and altitude are not displayed on the HUD, and a CADC error message will be displayed on the CDU alphanumeric display. On the ground, the CADC outputs an arbitrary 70 KIAS value. The self-test mode, activated by depressing the CADC BIT switch indicator on the CDU, will display 300 knots and 5,000 feet on the HUD for 3 - 5 seconds. The CADC receives power from the right AC bus and DC power from the right DC essential bus.

CADC Caution Light [62]

The CADC caution light (figure 1-65), located on the caution light panel, will come on when CADC data is unreliable, or the CADC has failed.

Altimeter

The altimeter (figure 1-33) is a combined pneumatic altimeter and servo repeater indicator. The pneumatic mode operates in a normal barometric manner. The normal mode of operation is the servoed mode, which is obtained by placing the function switch on the lower right corner of the instrument case in RESET or ELECT, when normal aircraft power is available. During pneumatic operation, a STBY or PNEU flag appears on the instrument face to indicate pneumatic operation.

When transferring modes, hold the function switch momentarily in the selected mode to allow system transfer.

During pneumatic operations, an internal vibrator operates to minimize friction to allow a smoother display during altitude changes. A quivering pointer and counter-drum may be noticeable due to vibrations set up by the vibrator. This is an indication that the vibrator is operating and normal, provided excursions of the pointer are not excessive. Should vibrator failure occur, the altimeter continues to function pneumatically, but the quivering will not be present and a less-smooth movement of the instrument display is evident with changes in altitude.

CENTRAL AIR DATA COMPUTER AND INTERFACES 62

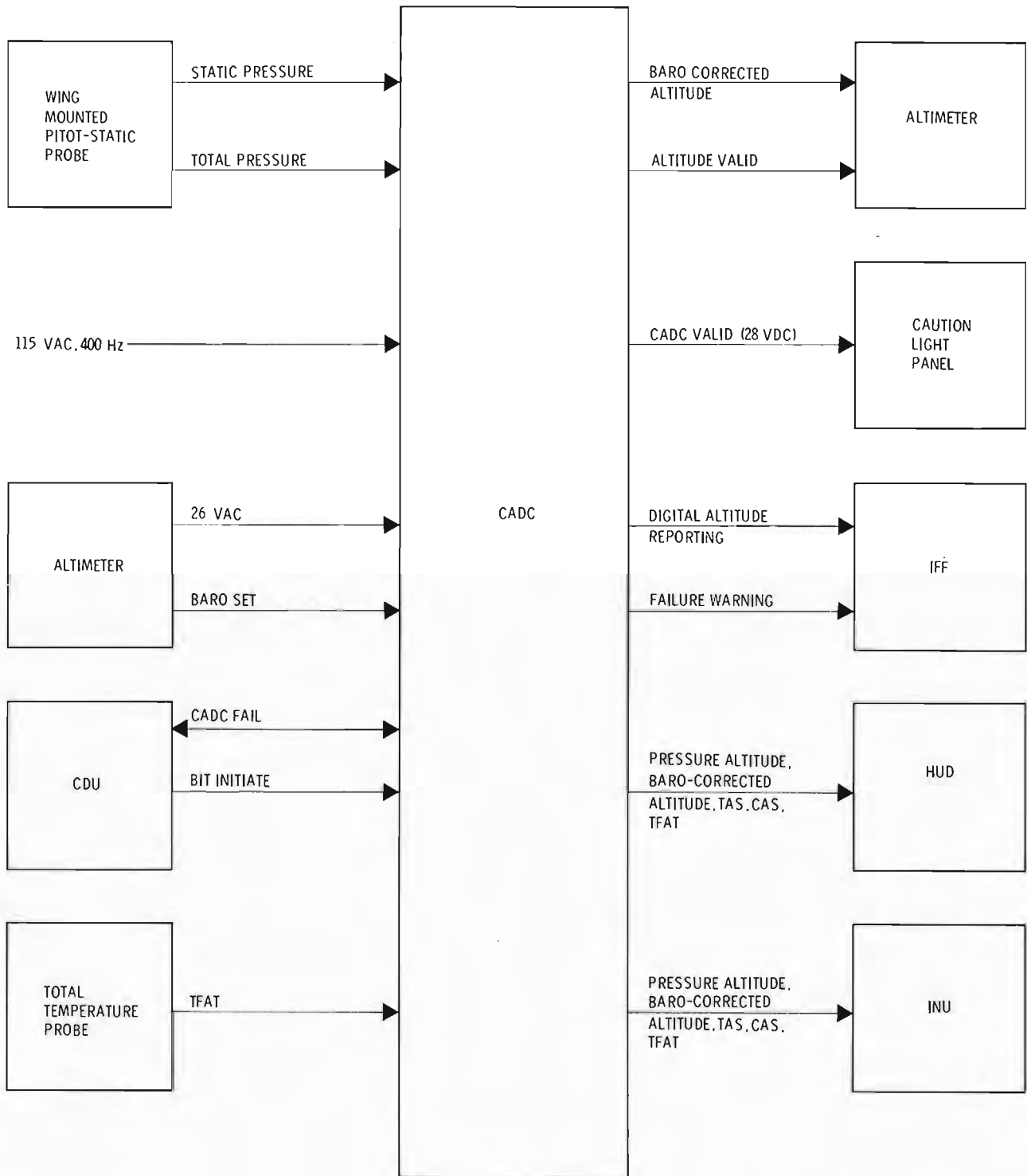

1-10A-1-77

Figure 1-32

ALTIMETER

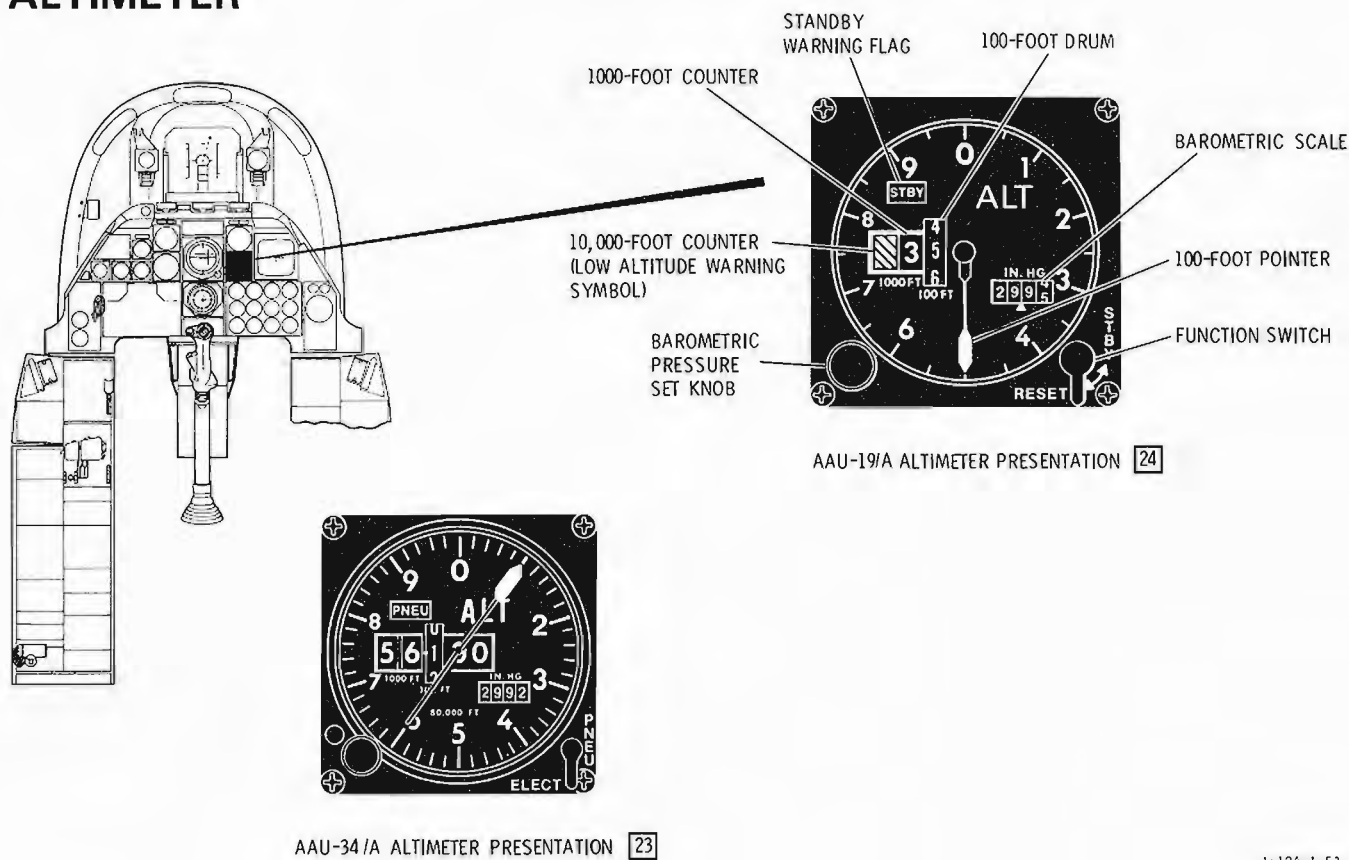

1-10A-1-53

Figure 1-33

WARNING

- During pneumatic operation, if the altimeter's internal vibrator is inoperative due to either internal failure or DC power failure, the 100-foot pointer may momentarily hang up when passing through 0 (12 o'clock position). If the vibrator has failed, the 100-foot pointer hangup can be minimized by tapping the case of the altimeter.
- During normal use of the barometric pressure set system, momentary locking of barocounters may be experienced. If this

occurs, do not force the setting. Application of force may cause internal gear disengagement, thereby resulting in excessive altitude errors in both the standby and servo modes. If locking occurs, the required setting may be established by rotating the knobs a full turn in the opposite direction and approaching the setting carefully.

- If altimeter setting knob can be moved in or out and the pointer moves without a corresponding change of the barometric setting when the knob is rotated, the altimeter is unacceptable for flight.

Airspeed Indicator

The airspeed indicator (25, figure FO-1), on the instrument panel, is graduated CW from a 50-knot minimum indication in increments of 10 knots to a maximum indication of 550 knots. A barrel in the top center of the dial displays a scale from 0 – 100 knots, in 2-knot increments. The striped pointer, which is altitude compensated, moves to indicate the limiting structural airspeed or the airspeed representing the limiting Mach number. A yellow mark indicates the limiting airspeed for use of full wing flaps and gear extension. The airspeed indicator operates from inputs of impact and static pressures. On [61], the airspeed indicator provides speed data to the HUD, and the HUD airspeed scale should read within 4 knots of the cockpit airspeed indicator.

Vertical Velocity Indicator

The VVI (27, figure FO-1), on the instrument panel, is a static pressure instrument receiving inputs directly from the pitot-static probe. The VVI provides rate of climb, or descent, in feet per minute. The indicator is calibrated in thousands of feet per minute. From 0 – 1,000 feet, up or down, the scale is in increments of 100 feet.

HEADING ATTITUDE REFERENCE SYSTEM

The HARS consists of a gyro platform, an amplifier, and a control panel (figure 1-34). On [61], the HARS provides pitch and roll signals to the ADI, heading data to the TACAN and the compass card in the HSI, bank angle to the Beta Dot SAS, and pitch and roll attitude to the HUD. A HARS failure is indicated when the ADI off flag is displayed and HUD roll tabs are not displayed. In addition, the HARS supplies turn rate signals to the turn needle in the ADI. On [62], the HARS is a backup heading and attitude system. HARS will automatically supply heading and attitude information when aircraft power is initially applied, the INS is off, the INS is in an alignment mode, or the INS attitude fails. HARS can be selected, but not deselected, by depressing the HARS switch-indicator on the navigation mode select panel. HARS can be deselected (operative INS) by selecting NAV CRS or MAN on the navigation mode select panel. On [64], a HARS/SAS validity assembly monitors the performance of HARS roll and pitch, and if a failure is detected, yaw SAS is automatically disengaged. The HARS is powered by the right AC bus.

HARS Caution Light [64]

The HARS caution light (figure 1-65), located on the caution light panel, comes on when the HARS heading or attitude is invalid, whether INS or HARS is selected as the operating attitude reference system.

HARS Fast Erect Switch

A HARS fast erect switch (figure 1-35), located on the control stick on [61], also serves as the nosewheel steering button. On [62], the HARS fast erect switch is located on the left side of the main instrument panel and is independent of the nosewheel steering. The fast erect switch is used to eliminate errors in HARS attitude displays. To prevent erection to a false vertical, the fast erect switch should be depressed only during straight and level, unaccelerated flight. The fast erect function will operate on the ground or in the air. When HARS is the operating attitude reference, depressing the HARS fast erect switch will cause the ADI and HSI power off flags to come into view, and will remove pitch angle and roll bar displays from the HUD.

Slaved Mode Operation

The slaved mode of operation is the normal mode of heading reference. The controls and indicators involved are the SLAVE-DG mode selector, the PUSH-TO-SYNC control, and the SYN-IND annunciator. The slaved mode is initiated by placing the SLAVE-DG mode selector switch in SLAVE, the N-S toggle switch to the appropriate northern (N) or southern (S) hemisphere position, and the LAT control to the correct latitude.

In slaved mode, the heading signal inputs are slaved so that heading output agrees with the magnetic heading sensed by the remote compass transmitter. The SYN-IND annunciator on the HARS control panel displays the magnitude and polarity of slaved heading error. The system can be synchronized manually (much faster than by the normal slaving rate) by use of the PUSH-TO-SYNC control on the HARS control panel. Depressing the PUSH-TO-SYNC control causes the system to synchronize, and the pointer on the SYN-IND annunciator will center. In normal flight operation, slight movement of the SYN-IND annunciator pointer about the center mark indicates proper slaving action.

Automatic synchronization takes place on power application and whenever the SLAVE-DG mode selector is switched from DG to SLAVE mode.

HEADING ATTITUDE REFERENCE SYSTEM CONTROL PANEL

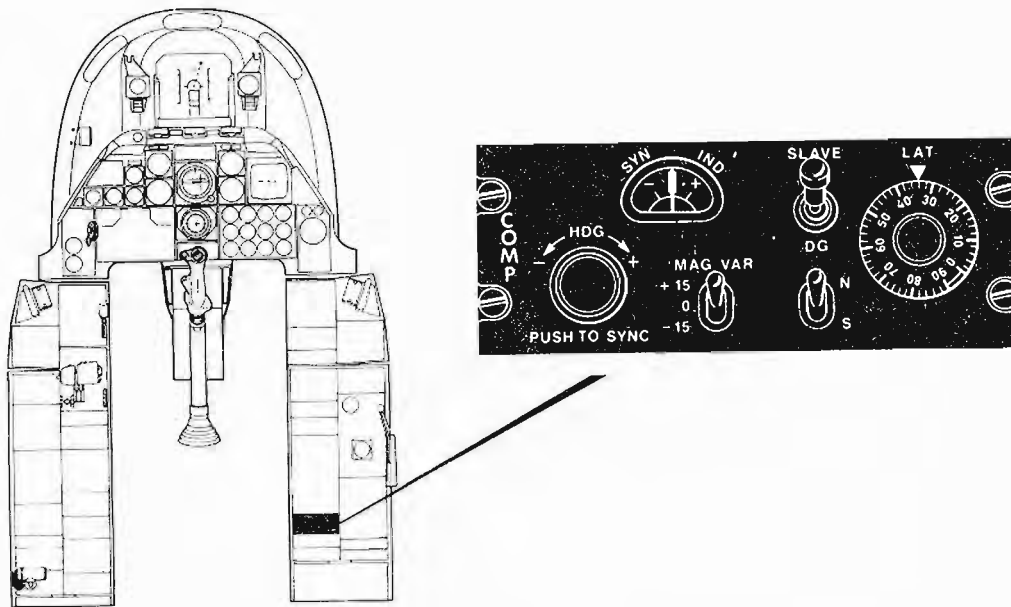

1-10A-1-54

<u>Control Indicator</u>	<u>Position or Display</u>	<u>Function</u>
SYN-IND (annunciator)		Indicates synchronization between HARS output and the remote compass transmitter when in SLAVE mode. When the system is not synchronized, the SYN-IND annunciator indicates in which direction the system must be corrected.
Mode selector switch	SLAVE	Selects HARS mode of operation. The system aligns with the remote compass transmitter, causing the system to operate as a gyro-stabilized magnetic compass. SLAVE is the normal operating mode.
	DG	The remote compass transmitter is disconnected from the system, reverting operation to that of a basic directional gyroscope.
LAT correction control		Corrects the system for the apparent drift of the directional and vertical gyros caused by the earth's rotation. The direction of correction for the northern or southern hemisphere is selected by the N-S hemisphere selector switch. The latitude correction is applied in both SLAVE and DG modes of operation.

Figure 1-34. (Sheet 1 of 2)

<u>Control Indicator</u>	<u>Position or Display</u>	<u>Function</u>
N-S hemisphere selector switch		Determines polarity of DG earth rate correction.
MAG VAR switch		Compensates for magnetic variation. The MAG VAR switch is set to the position which provides the closest representation of the magnetic variation at the aircraft's position, providing improved earth rate correction.
HDG PUSH-TO-SYNC control	Pushed In	Provides fast synchronization of heading. In SLAVE mode, synchronizes the system to 1° within 6 seconds. In DG mode, turning the control changes heading output at a rate proportional to knob displacement to a maximum of 30° per second.

Figure 1-34. (Sheet 2 of 2)

HARS FAST ERECT / INS MARK / UPDATE SWITCH

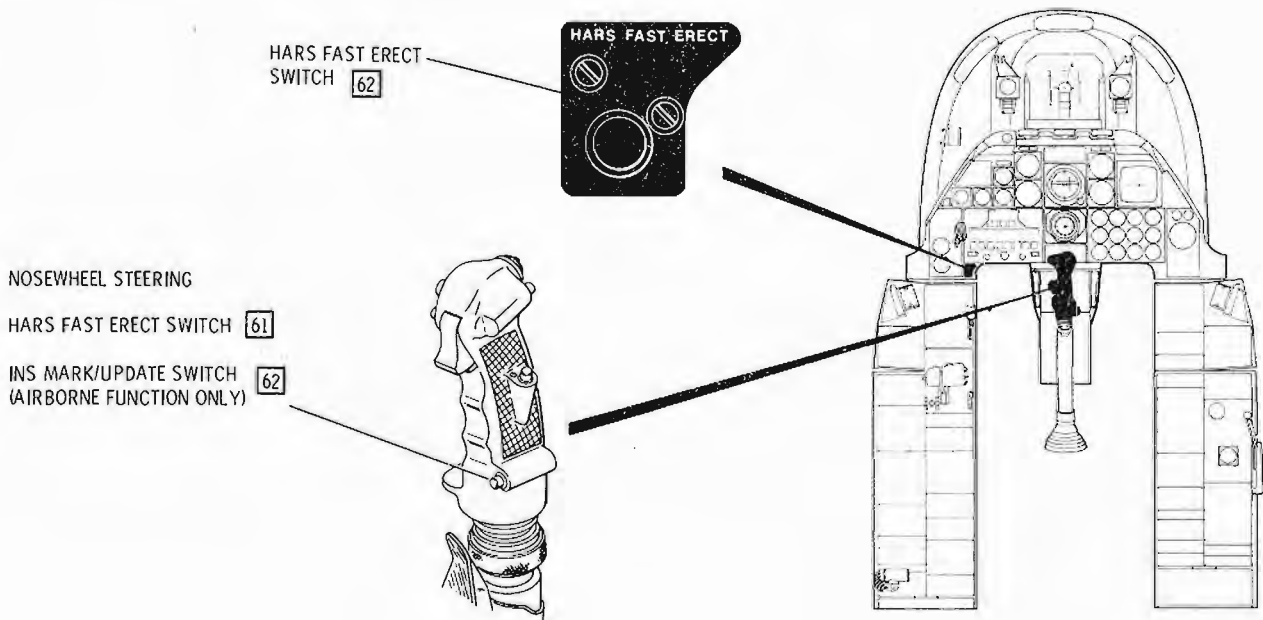

1-10A-1-70

Figure 1-35

Vertical Gyro Operation

The vertical gyro provides pitch and roll information to aircraft systems and vertical information to the DG. The vertical gyro is erected to local gravity.

DG Mode Operation

The DG mode of operation is a backup mode of heading reference in the event of a malfunction in the slave mode.

The heading indicator can be aligned by placing the mode selector switch in DG and pushing in and rotating the HDG PUSH-TO-SYNC control until HSI heading agrees with the standby compass.

In the DG mode, no heading information is received from the remote compass transmitter.

ANGLE-OF-ATTACK SYSTEM

The AOA system consists of a vane-transmitter, a cockpit indicator, and indexer lights. The vane-transmitter is located on the left side of the forward fuselage.

The AOA system measures the angle between the longitudinal axis of the aircraft and the relative wind. This information is presented in the cockpit on the AOA indicator and AOA indexer. The vane transmitter is provided with a heater which is controlled by the pitot heater switch.

Angle-of-Attack Indicator

The AOA indicator (24, figure FO-1), is placarded ANGLE OF ATTACK. The scale is calibrated from 0 - 30 arbitrary units, in single unit increments, increasing in a CCW direction. Reference marks are provided as follows: At 15.6 scale units a rectangular maximum range index; at 17.5 scale units a triangular maximum endurance index; at 21.5/110 20.0 scale units a T-shaped approach index; from 23.8 - 24.5/110 23.1 - 23.8 scale units a striped stall warning index. The red (OFF) flag will appear at the 3 o'clock position when the unit experiences a loss of power.

Angle-of-Attack Indexer

The AOA indexer (3, figure FO-1) presents AOA information during a landing approach by displaying illuminated symbols low-speed symbol “∨” (red), on-speed symbol “circle” (green), and high-speed symbol “^” (amber). Slightly low/high speed is indicated by the on-speed and low/high-speed symbols coming on simultaneously.

The AOA indexer lights operate only when the nose gear is down. The lighting control is located on the auxiliary lighting control panel (figure 1-65) and is powered by the right DC bus.

STALL WARNING SYSTEM

Stall warning is provided in the landing approach configuration (landing gear down or flap switch in DN) by a mechanical stick shaker operated off the AOA system. The stick shaker provides mild agitation of the control stick 4 - 12 knots prior to wing stall in unaccelerated (1 g) flight. The stick shaker is powered by the auxiliary DC essential bus. Stall warning is provided in the clean configuration (landing gear up and flap switch not in DN position) by an audible 600 Hz chopped tone. Tone activation is initiated by the Alpha/Mach computer as a function of AOA and MACH. The AOA is measured by a lift transducer vane mounted on the lower side of the left wing leading edge. This lift transducer is independent of the AOA system which initiates the stick shaker. A steady-peak performance tone is generated approximately two AOA units prior to stall and a chopped stall warning tone is generated approximately one AOA unit before stall. The chopped stall warning tone does not change in volume or frequency as AOA increases. Thus, actual wing stall or depth of stall are not indicated by this system. The two headset tones are controlled by separate volume knobs on the stall warning control panel. The audio stall warning system is powered by the DC essential bus. On 4, ignition is provided to both engines during activation of stall warning chopped tone and for 1 second after termination of stall warning.

On 102, stall warning is provided in the landing approach configuration (gear DOWN and/or flap switch MVR/DN) by both the mechanical stick shaker operated off the AOA system and audible tones operated off the lift transducer vane.

Stall Warning Control Panel

The stall warning control panel (figure 1-36) has two volume controls, placarded **STALL** and **PEAK PRFM**. The **STALL** volume control sets the volume of the chopped tone and has a minimum level equal to the landing gear warning volume. The **PEAK PRFM** volume control sets the volume of the steady tone and can be reduced to zero at the pilot's discretion.

Stall System Caution Light

The stall caution light (figure 1-65), on the caution light panel, is placarded **STALL SYS**. The light coming on indicates a power failure in the Alpha/Mach computer.

ACCELEROMETER

The accelerometer (2, figure FO-1) is suspended from the left side of the windshield bow.

NOTE

- When the GAU/8A gun is being fired, airframe vibration will cause the accelerometer needles to oscillate wildly, giving false maximum positive and negative readings which may exceed aircraft limits. The accelerometer should be zeroed after gunfiring to record subsequent g levels.

STALL WARNING CONTROL PANEL

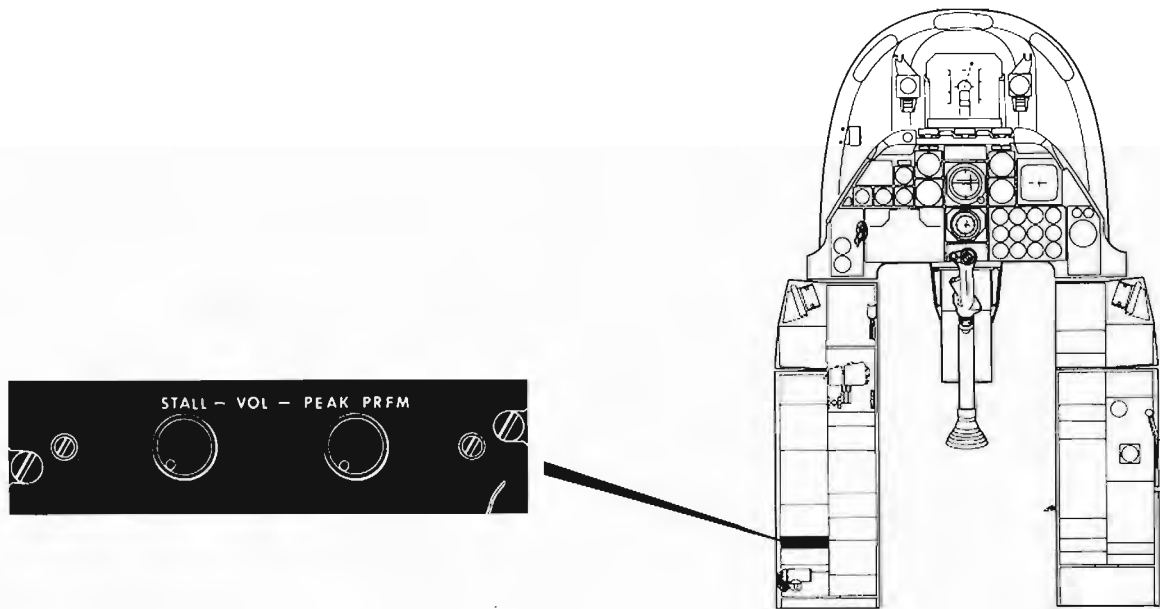

1-10A-1-57

Figure 1-36

CLOCK

The clock (23, figure FO-1), on the instrument panel, is a conventional 8-day mechanical stem-wound clock.

ATTITUDE DIRECTOR INDICATOR

The ADI (figure 1-37), located on the instrument panel, provides a display of aircraft pitch and bank attitude relative to the horizon. The ADI consists of a two-tone attitude sphere with graduated pitch references, fixed miniature aircraft, turn and slip indicator, pitch trim knob, pitch and bank steering bars, ADI off flag, glide slope deviation indicator

and warning flag, and course warning flag. The ADI is powered by the right AC bus.

HORIZONTAL SITUATION INDICATOR

The HSI (figure 1-38), located on the instrument panel, displays a plan view of navigation and positioning information. The HSI presents magnetic heading, bearing information from INS, TACAN and/or ADF, command heading information, course information, DME and TO-FROM information from a selected TACAN station or INS steerpoint, and displacement of aircraft from a selected course. The HSI compass card, bearing pointer, and course deviation scale are powered by the right AC bus.

ATTITUDE DIRECTOR INDICATOR (ADI)

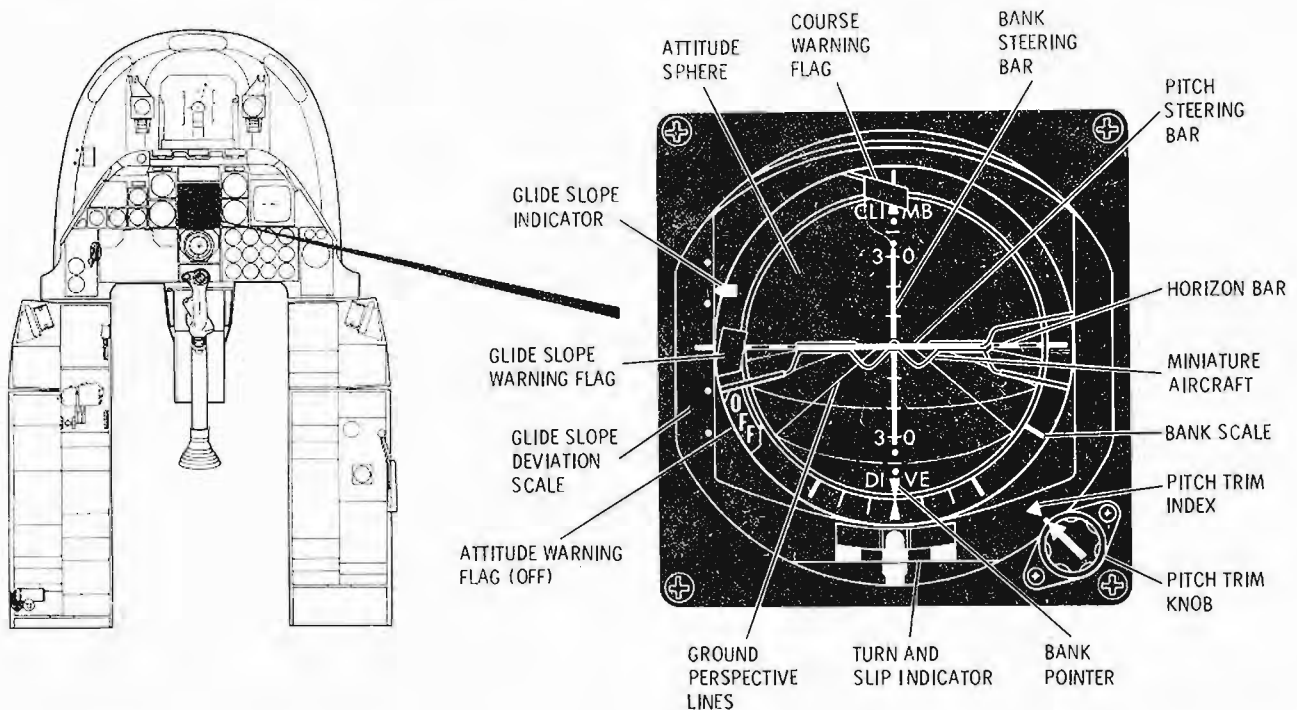

1-10A-1-55

Figure 1-37

HORIZONTAL SITUATION INDICATOR

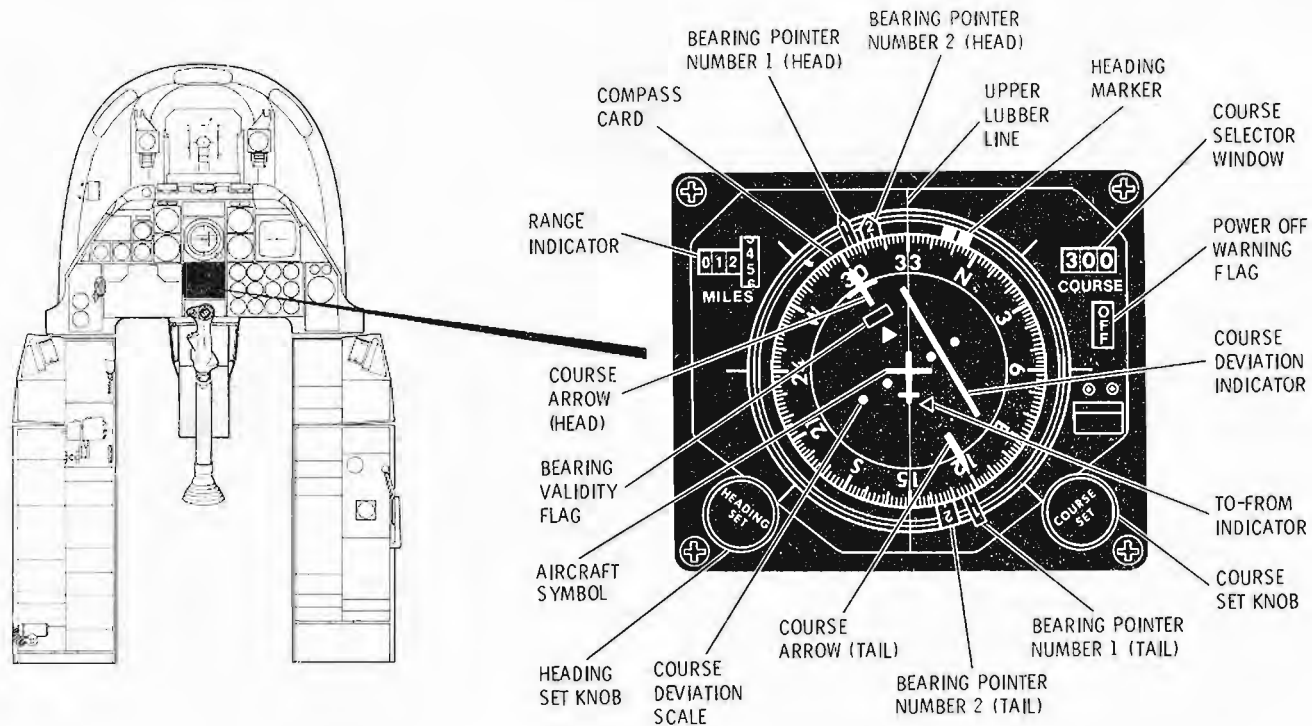

1-10A-1-56

Figure 1-38

ADI and HSI Power Off Flags

The ADI and HSI power off flags serve two functions. The first is an indication of power loss to either indicator. Only the flag of the instrument that has lost power will come into view. The second is to indicate when the HARS malfunction monitoring circuitry detects an invalid condition existing in the HARS. During normal operation the ADI and HSI power off flags will be in view under any of the following conditions:

- During heading synchronization in the SLAVE mode when operating in the HARS mode.

A power off flag in either or both instruments, under circumstances other than those listed previously, indicates a malfunction.



- Failure of certain components can result in erroneous or complete loss of attitude and heading presentations without a visible OFF flag. It is imperative that the ADI and HSI be cross-checked with other flight instruments when under actual or simulated instrument conditions.

STANDBY FLIGHT INSTRUMENTS

STANDBY COMPASS

The standby compass (5, figure FO-1) is a conventional liquid filled magnetic compass.

STANDBY ATTITUDE INDICATOR

The SAI (20, figure FO-1) provides an independent attitude indicating system in the event of failure of the ADI. The SAI receives its pitch and roll information from a self-contained gyro, powered by the DC essential bus, and will provide usable roll and pitch information within $\pm 6^\circ$ for a minimum of 9 minutes after loss of electrical power. A red warning flag will come into view whenever the indicator is caged or when electrical power is interrupted.

A pull-to-cage knob, located on the right side of the instrument face, provides for pitch trim adjustment. With the knob fully extended and rotated to the extreme CW position, the gyro will remain caged and the knob will remain locked in the extended position. Avoid snap release when uncaging.

At high AOA it may not always be possible to superimpose the miniature aircraft on the horizon bar in level flight.

COMMUNICATION/NAVIGATION

See figure 1-39 for a listing of communications and navigation aids installed in the aircraft.

ANTENNA LOCATIONS

Antennas used with the communication and navigation equipment installed in the aircraft are illustrated in figure 1-40.

NAVIGATION MODE SELECT PANEL

The navigation mode select panel (figure 1-41) is located on the instrument panel, and provides a central control point and display for inputs from navigation systems to the HSI and ADI. The navigation mode select panel contains seven pushbutton type switch-indicators, a two-position toggle switch, and two HOMING (UHF and FM) indicator lights. A triangle symbol in the lower half of each switch-indicator will come on to signify selected display mode. See figure 1-42 for navigation interfaces with the ADI and HSI.

TACAN (AN/ARN-118 (V))

The TACAN set (figure 1-43) provides the pilot with a continuous line-of-sight range and bearing to a ground TACAN station, or to a suitably equipped cooperating aircraft. The A-10 can provide A/A range information to another A-10 or suitably equipped aircraft, but cannot provide A/A bearing information. The TACAN set displays navigation data on the HSI.

TACAN-HSI Display

The TACAN information displayed on the HSI is in accordance with the mode selected at the navigation mode select panel.

When the TCN mode has been selected (Δ is on) and on [62] UHF/ADF not selected, bearing information will be displayed at all times by bearing pointer 1. When bearing lock-on occurs, the bearing validity flag will be out of view. When range lock-on occurs the range shutter will uncover the MILES indicator which displays the TACAN station range. If the course pointer is positioned approximately within $\pm 90^\circ$ of the bearing pointer, the TO-FROM indicator will indicate TO. If the course pointer is approximately more than $\pm 90^\circ$ displaced from the bearing pointer, the TO-FROM indicator will indicate FROM.

The TACAN, operating in conjunction with the HSI, provides the pilot with a course deviation function. The pilot, using the COURSE SET knob, selects a desired TACAN radial or course. The course deviation bar will deflect either to the right or left of the course pointer. This indicates the aircraft is either to the right or left of the selected course. Within approximately $\pm 10^\circ$ of the selected course, the course deviation bar will indicate the relative position of the aircraft from the selected course. When the course deviation bar is aligned with the course pointer, the aircraft is on the selected course or radial.

TACAN Controls

The TACAN set control panel (figure 1-43) contains all controls necessary for channel selection, operating mode selection, pulse mode selection (X or Y), volume control, and self-test.

TACAN Antennas

The TACAN antenna system consists of an upper and lower antenna which are shared with the UHF radio.

COMMUNICATIONS AND NAVIGATION AIDS

Type	Designation	Function	Range	Control Location
VHF/FM Radio 56	FM-622A	Provides two-way communications in the frequency modulation band of 30 – 75.95 MHz.	Line of sight	Left console
VHF/FM Radio 57	AN/ARC-186(V)	Provides two-way communications in the frequency modulation band of 30 – 76 MHz. 20 preset channels may be stored.	Line of sight	Left console
VHF/AM Radio 56	Wilcox 807A	Provides two-way communications in the 116.000 – 149.975 MHz band.	Line of sight	Left console
VHF/AM Radio 57	AN/ARC-186(V)	Provides two-way communications in the 116.000 – 151.975 MHz band. 20 preset channels may be stored.	Line of sight	Left console
UHF Radio	AN/ARC-164(V)	Provides UHF communications and ADF in the 225.000 – 399.975 MHz frequency range. 20 preset channels may be stored.	Line of sight	Left console
Intercommunications System	AIC-18	Aircraft communication center; permits audio monitoring and transmitter selection. All audio signals and landing gear warning signals are routed through the AIC-18. During ground operations permits interphone communication between pilot and groundcrew.	Dependent on function selected	Left console
Airborne Transponder (IFF)	AN/APX-101	Provides automatic radar identification to suitably equipped challenging aircraft, surface ships, and ground facilities within range.	Line of sight	Left console
TACAN System	AN/ARN-118(V)	Provides navigational information in conjunction with a surface navigation beacon or with another airplane equipped with similar TACAN system.	Line of sight	Right console
X-Band Radar System	AN/UPN-25	Enhances the control and vectoring capability of the aircraft by ground or air based radars.	Line of sight	Left console

Figure 1-39. (Sheet 1 of 2)

COMMUNICATIONS AND NAVIGATION AIDS (CONT)

Type	Designation	Function	Range	Control Location
Automatic Direction Finder		Provides bearing information to selected station transmitting on UHF.	Line of sight	Left console (thru UHF radio)
ILS 47	AN/ARN-108	Provides vertical and horizontal guidance information for instrument landings.		Right console
INS 62		Provides heading, attitude, ground speed, TAS, winds, course to destination or steerpoint, and present position data for worldwide navigation capability.		Right console

Figure 1-39. (Sheet 2 of 2)

TACAN Modes of Operation

The TACAN set has four modes of operation: receive, transmit-receive, air-to-air receive, and air-to-air transmit-receive. Refer to figure 1-43 for a description of each mode of operation.

The TACAN set has two self-test modes. The manual self-test mode is initiated by setting the mode switch to T/R and depressing the TEST pushbutton. If the TEST indicator is still on at the end of the self-test cycle, a malfunction or failure has occurred. The test should then be repeated in the REC mode. If the TEST indicator is not on at the end of the self-test cycle in the REC mode, the malfunction is probably in the transmitter and the bearing information is valid. If the TEST indicator is on at the end of the self-test cycle in the REC mode, all information received should be considered invalid. Self-test mode can be terminated at any time by rotating either a channel knob or the mode selector. The automatic self-test mode occurs automatically whenever the received signal becomes unreliable or is lost (memory time elapsed). If the TEST indicator is found to be on in flight, a manual self-test should be initiated to confirm the malfunction and to determine limitations.

TACAN Operation

To operate the TACAN, proceed as follows:

1. Set operating mode (OFF-REC-T/R - A/A REC - A/A T/R) selector switch to desired mode. Allow a 90-second warmup period.

NOTE

- T/R and A/A T/R modes should not be used when radio silence conditions are imposed. Do not use channels 1 - 9, 64 - 72, and 126 in A/A modes, due to IFF interference.

When operating in either of the A/A modes, the frequency of the master aircraft and all receiver aircraft must be in the same X/Y mode and spaced 63 channels apart, i.e. MASTER: Y mode channel 10, Receivers: Y mode channel 73. Additionally, when multiple flights are using A/A mode in close geographical proximity, paired channels should be spaced at least two channels apart.

2. Rotate two channel switches to desired channel, as displayed in CHANNEL indicator window.

ANTENNA LOCATIONS/IFF CODING

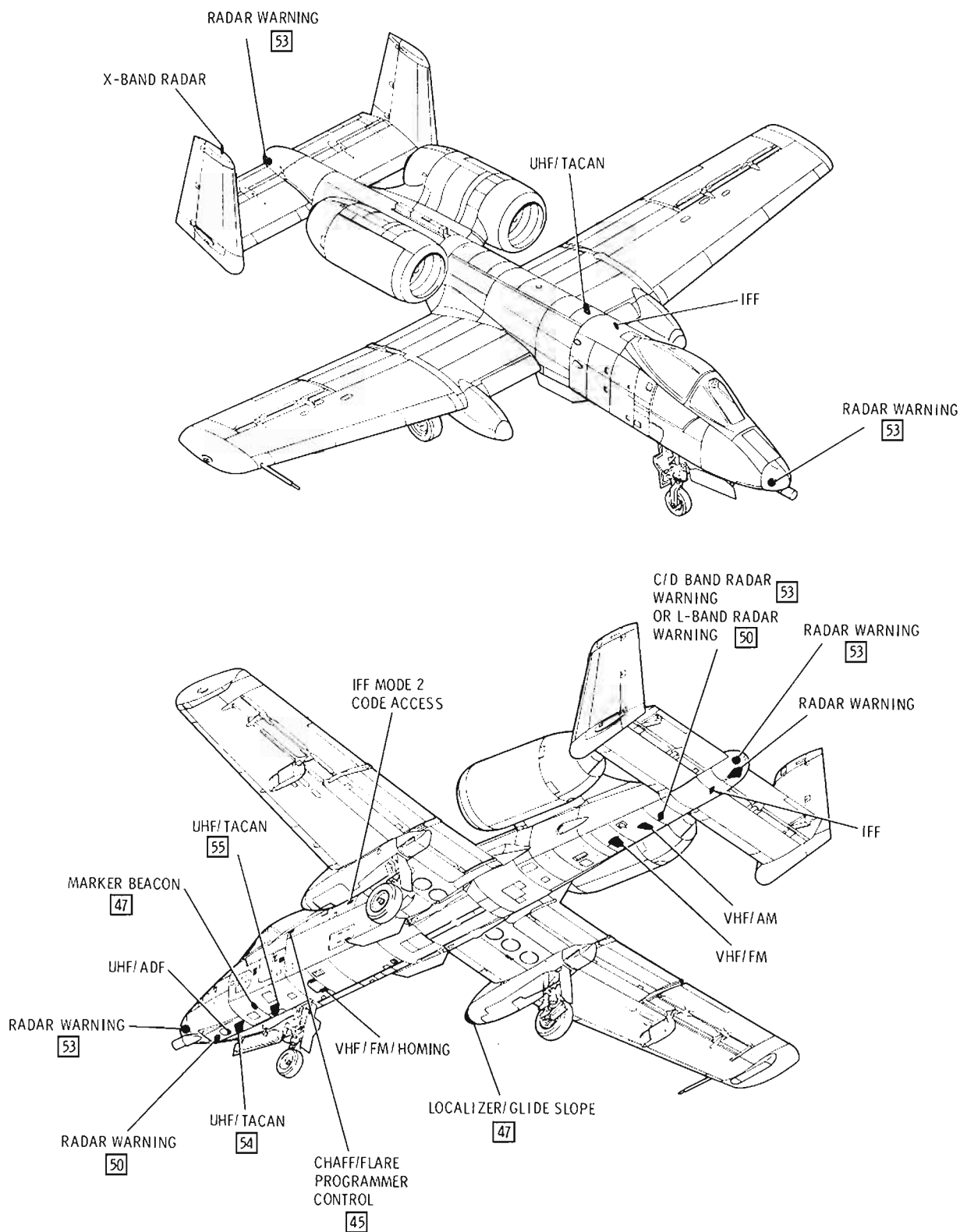

41-10A-1-11

Figure 1-40

NAVIGATION MODE SELECT PANEL

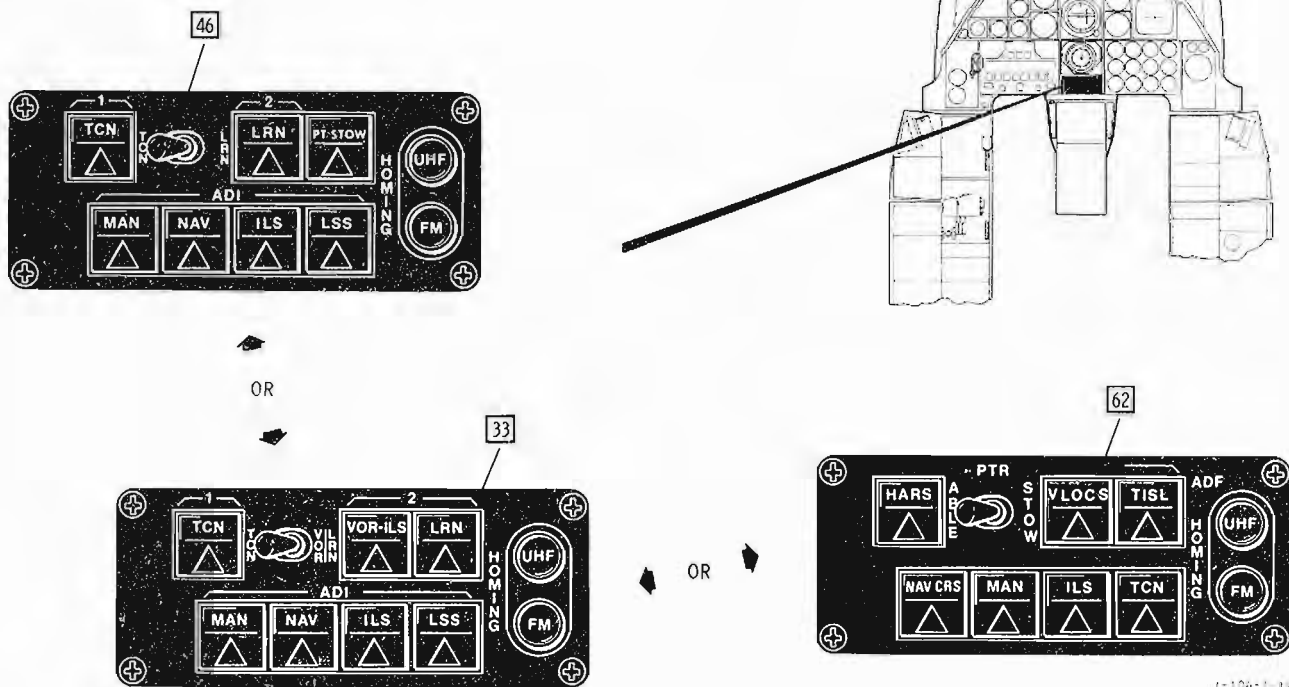

Control or Indicator	Position	Function
TCN switch-indicator	Depress	Selects TACAN for display on HSI and on [62], ADI bank steering.
TCN-VOR/LRN or TCN-LRN toggle switch [46] [33]	—	Nonfunctional.
VOR-ILS switch-indicator [33]	—	Nonfunctional.
LRN switch-indicator	—	Nonfunctional.
PT STOW switch-indicator [46]	Depress	Stows the following indicators on the ADI out of view: bank steering bar, pitch steering bar, and course warning flag.
PTR switch [62]	ABLE	Enables the pitch/bank steering bars and the course warning flag on the ADI.
	STOW	Stows the pitch/bank steering bars and the course warning flag, except when TISL or FM homing is selected.

Figure 1-41. (Sheet 1 of 2)

<u>Control or Indicator</u>	<u>Position</u>	<u>Function</u>
MAN switch-indicator 46	Depress	In conjunction with the heading set knob on the HSI, steering information is displayed on the ADI. Interlocked with NAV, ILS, and LSS.
MAN switch-indicator 62	Depress	Same as NAV CRS, except the CDI is nonfunctional.
NAV switch-indicator 46	Depress	TACAN steering information is displayed on the ADI. Interlocked with MAN, ILS, and LSS.
ILS switch-indicator 62 46	Depress	ILS steering and raw glide slope information are displayed on the ADI. Raw localizer information is displayed on the HSI. Interlocked with MAN, NAV, and LSS.
LSS switch-indicator 46 33	Depress	TISL (laser spot seeker) raw azimuth and elevation pointing data is displayed on the ADI. The LSS or TISL switch-indicator has priority over the FM light and when depressed the FM light will not come on. On 46, interlocked with MAN, NAV, and ILS.
TISL switch-indicator 62		
UHF light	—	Comes on amber when ADF mode is selected on the UHF control panel.
FM light	—	Comes on amber when homing mode is selected on VHF/FM control panel and the LSS or TISL mode has not been selected. When the homing mode is selected, course deviation and relative signal strength will be displayed on the ADI via the pitch/bank steering bars. On 46, the FM light will not come on nor will homing data be displayed on the ADI if any switch-indicator controlling ADI displays is selected. On 62, only TISL takes precedence over VHF/FM when selected.
HARS switch-indicator 62	Depress	Selects HARS as the operating heading and attitude system providing this data to the ADI, HSI, and HUD
LOC switch-indicator 62	Depress	Localizer steering data is displayed on the ADI and raw localizer information is displayed on the HSI.
NAV CRS switch-indicator 62	Depress	Selects INS as the operating heading, steering and attitude system and provides this data to the ADI, HSI, and HUD. Pitch and bank steering bars are stowed out of view.

Figure 1-4I. (Sheet 2 of 2)

NAVIGATION INTERFACE CHART 61

SWITCH-INDICATOR(S) SELECTED	HSI BEARING POINTER #1	HSI BEARING POINTER #2	HSI RANGE INDICATOR	HSI CDI	HSI HEADING MARKER	ADI BANK STEERING BAR	ADI PITCH STEERING BAR
<div style="border: 1px solid black; padding: 5px; width: fit-content; margin: 0 auto;"> TCN Δ </div>	MAGNETIC BEARING TO SELECTED TACAN STATION	MAGNETIC BEARING TO UHF STATION WHEN ADF SELECTED	DISTANCE TO SELECTED TACAN STATION	DEVIATION FROM TACAN COURSE	HEADING SELECTED BY HEADING SET KNOB	STOWED OUT OF VIEW TO RIGHT	STOWED OUT OF VIEW TO BOTTOM
<div style="border: 1px solid black; padding: 5px; width: fit-content; margin: 0 auto;"> TCN Δ </div> <div style="border: 1px solid black; padding: 5px; width: fit-content; margin: 0 auto;"> NAV Δ </div>	MAGNETIC BEARING TO SELECTED TACAN STATION	MAGNETIC BEARING TO UHF STATION WHEN ADF SELECTED	DISTANCE TO SELECTED TACAN STATION	DEVIATION FROM TACAN COURSE	HEADING SELECTED BY HEADING SET KNOB	TACAN BANK STEERING (EXCEPT 33)	STOWED OUT OF VIEW TO BOTTOM
<div style="border: 1px solid black; padding: 5px; width: fit-content; margin: 0 auto;"> MAN Δ </div>	—	—	—	—	HEADING SELECTED BY HEADING SET KNOB	HEADING BANK STEERING (EXCEPT 33)	STOWED OUT OF VIEW TO BOTTOM
<div style="border: 1px solid black; padding: 5px; width: fit-content; margin: 0 auto;"> TCN Δ </div> <div style="border: 1px solid black; padding: 5px; width: fit-content; margin: 0 auto;"> ILS Δ </div>	MAGNETIC BEARING TO SELECTED TACAN STATION	MAGNETIC BEARING TO UHF STATION WHEN ADF SELECTED	DISTANCE TO SELECTED TACAN STATION	RAW LOCALIZER INFORMATION	HEADING SELECTED BY HEADING SET KNOB	DISPLAYS LOCALIZER COURSE BANK STEERING (EXCEPT 33)	DISPLAYS GLIDE SLOPE PITCH STEERING (EXCEPT 33)

Figure 1-42. (Sheet 1 of 2)

NAVIGATION INTERFACE CHART 62

SWITCH-INDICATOR(S) SELECTED	HSI BEARING POINTER #1	HSI BEARING POINTER #2	HSI RANGE INDICATOR	HSI CDI	HSI HEADING MARKER	ADI BANK STEERING BAR	ADI PITCH STEERING BAR
<div style="border: 1px solid black; padding: 5px; width: fit-content; margin: 0 auto;"> NAV CRS Δ </div>	TACAN BEARING *	STEERPOINT BEARING	DISTANCE TO STEERPOINT	DEVIATION FROM STEERPOINT COURSE	WIND CORRECTED STEERPOINT BEARING	STOWED OUT OF VIEW TO RIGHT	STOWED OUT OF VIEW TO BOTTOM
<div style="border: 1px solid black; padding: 5px; width: fit-content; margin: 0 auto;"> MAN Δ </div>	TACAN BEARING *	STEERPOINT BEARING	DISTANCE TO STEERPOINT	NON-FUNCTIONAL	WIND CORRECTED STEERPOINT BEARING	STOWED OUT OF VIEW TO RIGHT	STOWED OUT OF VIEW TO BOTTOM
<div style="border: 1px solid black; padding: 5px; width: fit-content; margin: 0 auto;"> HARS Δ </div>	TACAN BEARING *	SLAVED TO BEARING POINTER #1	DISTANCE TO SELECTED TACAN STATION	NON-FUNCTIONAL	HEADING SELECTED BY HEADING SET KNOB	STOWED OUT OF VIEW TO RIGHT	STOWED OUT OF VIEW TO BOTTOM
<div style="border: 1px solid black; padding: 5px; width: fit-content; margin: 0 auto;"> TCN Δ </div> (INS MODE)	TACAN BEARING *	STEERPOINT BEARING	DISTANCE TO SELECTED TACAN STATION	DEVIATION FROM TACAN COURSE	HEADING SELECTED BY HEADING SET KNOB	TACAN BANK STEERING	STOWED OUT OF VIEW TO BOTTOM
<div style="border: 1px solid black; padding: 5px; width: fit-content; margin: 0 auto;"> TCN Δ </div> <div style="border: 1px solid black; padding: 5px; width: fit-content; margin: 0 auto;"> HARS Δ </div>	TACAN BEARING *	SLAVED TO BEARING POINTER #1	DISTANCE TO SELECTED TACAN STATION	DEVIATION FROM TACAN COURSE	HEADING SELECTED BY HEADING SET KNOB	TACAN BANK STEERING	STOWED OUT OF VIEW TO BOTTOM
<div style="border: 1px solid black; padding: 5px; width: fit-content; margin: 0 auto;"> ILS Δ </div> (INS MODE)	TACAN BEARING *	STEERPOINT BEARING	DISTANCE TO SELECTED TACAN STATION	RAW LOCALIZER INFORMATION	HEADING SELECTED BY HEADING SET KNOB	DISPLAYS LOCALIZER COURSE BANK STEERING	DISLAYS GLIDE SLOPE PITCH STEERING

Figure 1-42. (Sheet 2 of 2)

* ADF BEARING IF UHF ADF SELECTED

TACAN CONTROL PANEL—AN/ARN-118(V)

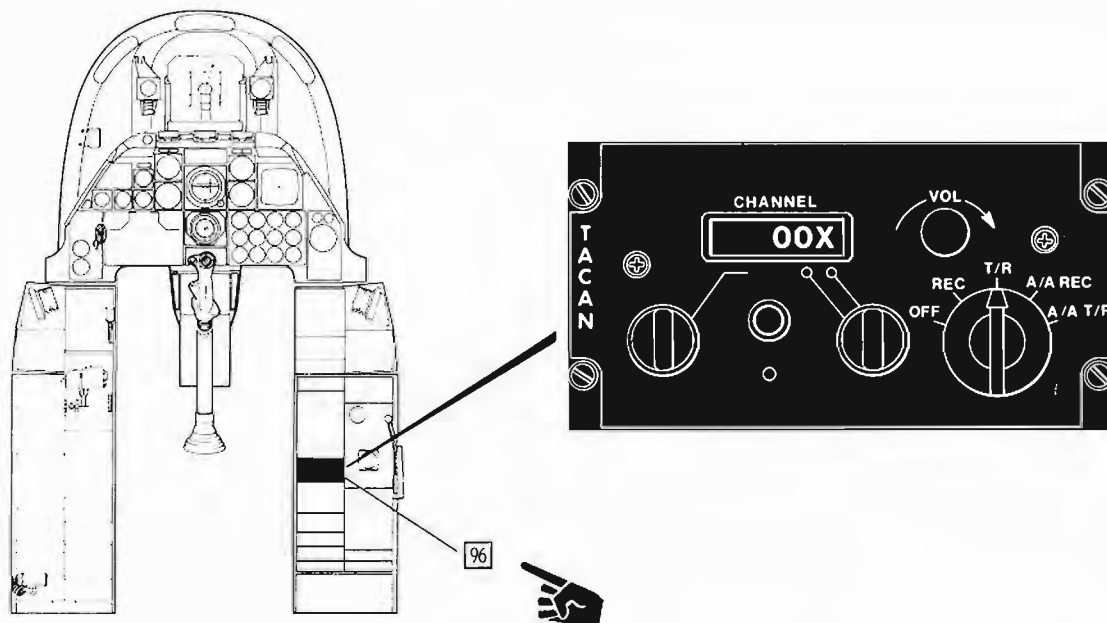

A 1-10A-1-58

<u>Control Indicator</u>	<u>Position or Display</u>	<u>Function</u>
CHANNEL digital display		Displays TACAN channel selected by the two channel selector switches.
X/Y pulse mode selector switch (outer ring CHANNEL units selector switch)		Permits selection of either X or Y pulse mode of operation.
VOL control		Controls the volume of the station identification.
Operating mode selector switch	OFF	Disconnects power to TACAN set.
	REC	TACAN set operates in receive mode only and provides bearing information, course deviation, and station identification.

Figure 1-43. (Sheet 1 of 2)

<u>Control Indicator</u>	<u>Position or Display</u>	<u>Function</u>
Operating mode selector switch (Cont)	T/R	TACAN set operates in both transmit and receive modes, providing bearing, range, deviation, and station identification information.
	A/A REC	TACAN set provides air-to-air bearing information when operating with a suitably equipped reference aircraft.
	A/A T/R	TACAN system provides range and relative bearing to a suitably equipped, cooperating aircraft. If the reference aircraft is not equipped with bearing producing equipment, only slant-range is provided. The A-10 is not equipped with bearing producing equipment. In this mode, the TACAN system provides distance replies to other aircraft when interrogated.
Channel selector control		Selects the desired TACAN channel.
TEST pushbutton	Pressed	Initiates TACAN self-test mode. In self-test mode, HSI indications are; distance shutter in view, course deviation flag in view, bearing pointers slew to 270° for nominal 7 seconds. After 7 seconds, distance shutter and course deviation flag go out of view, distance indicator indicates 000 miles, bearing pointers lock onto 180°. After nominal 15 seconds, distance and bearing flags come into view and bearing pointers rotate CCW.
TEST indicator		Lights when malfunction occurs during manual or automatic system self-test. Flashes at start of test cycle to check indicator lamp.

Figure 1-43. (Sheet 2 of 2)

3. Set X/Y switch to the desired X or Y mode. The X mode should be selected unless otherwise required by the appropriate flight publications.

4. Pull out the TCN monitor switch on intercom control panel and adjust VOL control on TACAN panel for desired audio level. Audio may also be controlled at the TCN monitor volume control on the intercom control panel.

5. At the navigation mode select panel, depress TCN pushbutton switch to provide TACAN data for presentation on the HSI (Δ is on).

INSTRUMENT LANDING SYSTEM 47

The ILS consists of a receiver (AN/ARN-108), control panel, and three antennas for the reception of localizer, glide slope, and marker beacon signals.

Localizer deviations are presented on the HSI and glide slope deviations on the ADI. Both the ADI and HSI have warning flags which come into view to indicate that the glide slope or localizer signal is unreliable. In addition to these visual signals, a localizer audio is available. The localizer receiver operates on 40 channels at a frequency range of

108.1 - 111.95 MHz. The radio receiver also provides audible and visual signals to indicate passage over a marker beacon. When this occurs, the MARKER BEACON signal light (15, figure FO-1) will come on and an audio tone will be heard in the headset. Localizer and marker beacon audio is enabled through the use of the ILS monitor switch on the INTERCOM control panel (figure 1-59). The VOL control on the ILS control panel varies the volume of the localizer audio only. The ILS monitor switch and VOL control on the INTERCOM control panel varies beacon and localizer audio signals.

The ILS control panel, on the right console, is described and illustrated in figure 1-44. The ILS is powered from the right AC and DC busses.

ILS ADI/HSI Display

To obtain ILS indications, the ILS switch-indicator on the navigation mode select panel (figure 1-41) is depressed. ILS localizer deviation signals are supplied to the CDI on the HSI (figure 1-38) and ILS glide slope deviations signals to the GSI on the ADI (figure 1-37). The TO-FROM indicator will be stowed out of view and the bearing validity flag will reflect localizer receiver status. After ILS selection and prior to localizer capture, the bank steering bar on the ADI will be out of view. Bank steering will not be available until the CDI is within an equivalent displacement of 2.6 dots. The CDI will move off the stops and begin displaying valid displacement information. If steering commands are satisfied, the aircraft will intercept the localizer inbound course. Maximum bank command during localizer intercept is limited to 30°. Prior to glide slope capture the pitch steering bar on the ADI is out of view. Glide slope capture occurs automatically when the aircraft is within 1/2 dot GSI deviation. Upon capture, the pitch steering bar comes into view at an initial 2° pitch down command position to facilitate glide slope capture, and then commands interception of the glide path. Maximum bank command after glide slope capture is 15°. Following localizer or glide slope capture, the steering bars will remain in view until a different switch-indicator (MAN, NAV, or LSS on [61], or NAV CRS, MAN, TCN, or LOC on [62]), is depressed or the ILS switch-indicator is depressed again to turn the ILS mode off.

NOTE

- During back course localizer approaches, the ADI steering command bars and glide slope deviation indicator present incorrect information. Stow the bank and pitch steering bars on the ADI by depressing the PT STOW switch-indicator on [46], or by setting PTR switch to STOW [62], on the navigation mode select panel, and disregard glide slope deviation indications.
- If localizer and glide slope capture occur at the same time, the commanded bank angle will be limited to 15° which may cause a significant localizer overshoot. In this case, disregard command steering, and fly the aircraft as required to intercept the localizer.

ILS OPERATION

1. INTERCOM control panel — Set.
 - a. VOL control knob — Midposition.
 - b. ILS monitor switch — Pull out and place in midposition.
2. ILS control panel — Set.
 - a. Frequency dial — Set in selected localizer frequency.
 - b. VOL control knob — Midposition.
 - c. PWR switch — PWR.
3. HSI course selector window — Set in published inbound localizer course.
4. Navigation mode select panel — Set.
 - a. ILS switch-indicator — Depress. Check ILS Δ comes on.

INERTIAL NAVIGATION SYSTEM [62]

The INS is the primary aircraft attitude system and provides a world-wide navigation capability. The INS measures aircraft acceleration and computes aircraft

ILS CONTROL PANEL 47

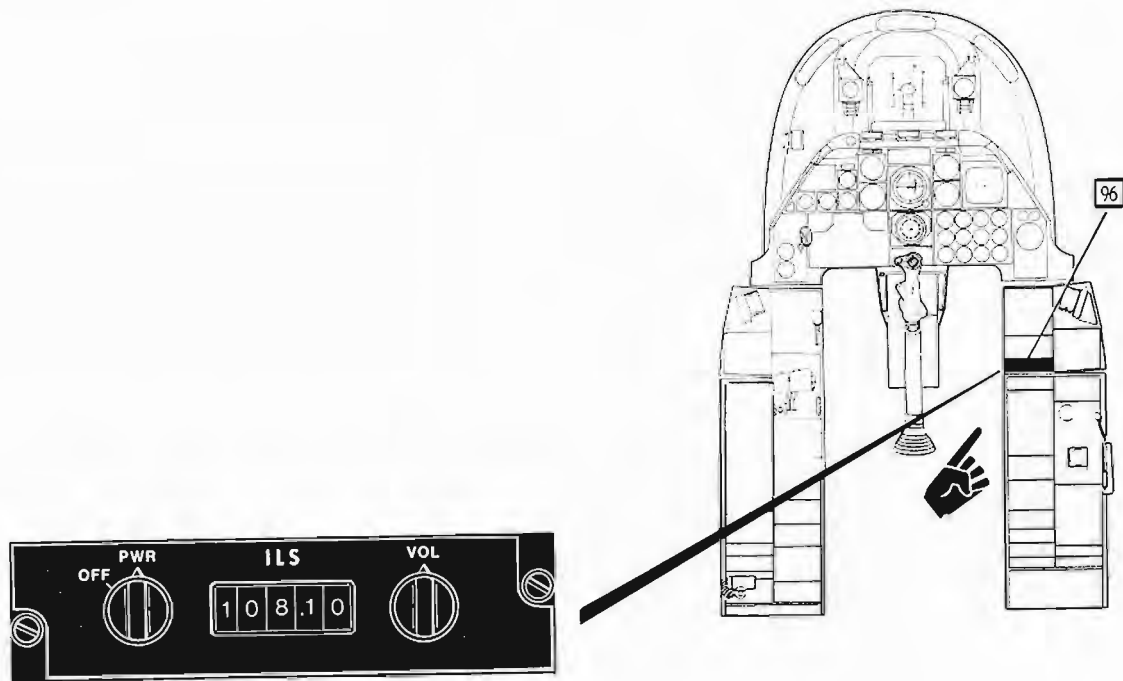

A1-10A-1-13

<u>Control or Indicator</u>	<u>Position</u>	<u>Function</u>
PWR control knob	OFF	Removes power from ILS.
	PWR	Applies power to ILS.
Frequency control knobs	—	Used to select the desired localizer frequency.
Frequency dial	—	Indicates the localizer frequency selected.
VOL control knob	—	Controls the volume of the localizer identifier audio signal.

Figure 1-44

track, ground speed, and present position (latitude/longitude). The INS, consisting of an INU, CDU, MBC, and CADC, interfaces with the HSI, ADI, and the HUD, when one of the INS modes is selected on the navigation mode select panel. The primary INS interface to the pilot is the HSI, providing the following:

- Magnetic heading
- Relative bearing of a selected steerpoint
- Distance to a selected steerpoint
- Relative direction of and deviation to a selected course.

A second INS interface to the pilot is the ADI, providing the following:

- Pitch
- Roll.

The other INS interface to the pilot is the HUD, providing the following displays:

- Pitch
- Roll
- Magnetic heading
- Time to go to steerpoint
- Distance to steerpoint
- Relative bearing to steerpoint
- Total velocity vector.

The INS provides point-to-point navigation with up to ten destinations and six mark points enterable before or during flight. If the system is found to be in error during flight, an update may be accomplished by overflying a known geographical point. If INS attitude is not valid, the backup (secondary) HARS automatically becomes the operating attitude reference system. The INS is powered by the right AC bus.

INS Steering Modes

There are two basic INS steering modes, GCS and SCS. The desired steering mode is selected via the CDU. The INU initializes to GCS at turn-on. GCS consists of two submodes, direct GCS and modified GCS. To use direct GCS, the HSI course set knob is used to center the CDI with the course arrow coin-

cident with bearing pointer number 2, which indicates computed magnetic bearing to the selected steerpoint. The HSI heading marker will indicate wind corrected desired magnetic heading to the selected steerpoint. Flying to keep the CDI centered will maintain the GCS course from present position to the selected steerpoint.

To use the modified GCS mode, the desired course is selected via the HSI course selector knob. Flying to intercept and track the desired course, either in-bound or out-bound may be done as if the selected steerpoint were a TACAN. Bearing pointer number 2 indicates magnetic bearing to the selected steerpoint, and the HSI heading marker will indicate desired magnetic heading direct to the steerpoint.

SCS, when selected via the CDU, provides desired magnetic course from present position at the time SCS is selected. The desired magnetic course must be set via the HSI course set knob to provide proper directional indications. HSI course arrow and course deviation displays will provide course information relative to the present position at the time of SCS selection. Bearing pointer number 2, heading set marker, and distance display are to the selected steerpoint, not the SCS point.

An alternate procedure for course entry is possible via the appropriate CDU page, and line select keys.

Inertial Navigation Caution Light

The INERTIAL NAV caution light (figure 1-65), located on the caution light panel, comes on when there is a failure in the CDU or INU, and is on while the INU is in an alignment mode.

Inertial Navigation Unit

The INU, located in the right avionics compartment, consists of a stabilized platform with two gyros and three accelerometers, a digital computer, power supplies, and an input/output function. The two gyros stabilize the platform, keeping it horizontal to the earth's surface, so the accelerometers sense only horizontal acceleration. The magnitude and direction outputs of the accelerometers are fed to the INU digital computer, where they are added vectorially and combined with starting point latitude and longitude. The computer then outputs present position latitude and longitude.

Master Bus Controller 62

The MBC is a processor that initiates, monitors, and controls data transfers over redundant data busses. The MBC selects which one of the two data busses will be used and examines the status words of both the transmitter and receiver terminals, as well as examining the data. The MBC is the primary bus controller, however, if an MBC malfunction occurs, the INU assumes control of the busses. When power is applied, the MBC clears, resets, and performs a start-up self-test to assume control of the data busses. A BIT feature provides a confidence check of all MBC circuitry, data bus line and terminal response on the data bus. BIT is initiated on the CDU. If a fault is detected, an MBC error message will be displayed on the CDU. The MBC receives power from the right AC bus.

Control Display Unit

The CDU, figure 1-45, provides the control and information interface between the pilot and the INS. The CDU controls the operating modes of the INS and indicates the INS operational status. The CDU contains alphanumeric displays, page and mode selectors, and the function pushbuttons. The CDU is powered by the right DC bus.

CDU Data Entry

The following paragraphs describe general procedures for entering data into the CDU for use by the INU.

Letters and Numbers

Each entry from the keyboard appears first in the scratchpad line of the CDU display. The scratchpad line is initially in number mode (1, 2, 3, etc.). Keyboard data is successively displayed from left to right in the scratchpad line. To enter letters, the LTR/USE key is pressed first and LTR appears to the right of the scratchpad line. Letter entry for latitude/longitude coordinate format only uses keys 2, 4, 6, and 8 and only the letters N, W, E, and S can be displayed in the scratchpad line. Once the desired letter appears in the scratchpad line, the LTR/USE key should be pressed again, causing LTR to clear from the scratchpad line and signal the CDU to use that letter. The CDU automatically reverts to the numeric mode after the letter has been entered. Numeric positions of latitude and longitude are entered directly.

In the UTM coordinate format, keys 2 - 9 each have three letters associated, excluding the letters I and O. To enter the first letter associated with a key, press the LTR/USE key so that LTR appears to the right of the scratchpad line, then press the character key once. To enter the second letter, press the character key twice. For the third letter, press the character key a third time. When the desired letter is displayed in the scratchpad line, press the LTR/USE key again to signal the CDU to use that alpha character. If a subsequent letter is required, repeat the above operation.

Clear Function

If an error is made in number or letter entry, pressing CLR once clears the last entry. Pressing CLR twice clears the entire scratchpad line.

Data Transfer

Once the desired data appears in the scratchpad line, it is entered by pressing the associated line select key (figure 1-46). When the line select key is pressed, the scratchpad line contents are checked by the CDU for proper range and format. If the entry is valid, it is transferred to the INU, transmitted from the INU back to the CDU, and displayed adjacent to the line select key. Completion of this cycle clears the scratchpad line.

Error Checking

Several checks are performed on entered data before it appears on the line and the scratchpad is cleared. Failure to pass these checks causes one of four messages to be displayed alternately with the unused entry. Entry errors indicate that the entered data has not passed format checks performed by the CDU.

1. **OUT OF RANGE** — Indicates the entered data has not passed range checks performed by the CDU (e.g., entry of longitude W84; the correct entry should be W084).
2. **ENTRY IGNORED** — Indicates that the entered data is inconsistent with INU operation (e.g., entry of MH or TH later than 1 minute after selecting FAST, or entry of present position later than 2 minutes after selecting FAST or NORM).

3. **ENTRY REJECTED** — The corresponding data output does not equal the operator's data input made via the CDU (e.g., entry of longitude W084° 06' 06'', but CDU display on line 7 is E073° 07' 07'').

4. **ENTRY ERROR** — Indicates that entered data has not passed format checks performed by the CDU (e.g., entry of N39° 43.8' latitude; correct entry is N39° 43' 48'').

CONTROL DISPLAY UNIT

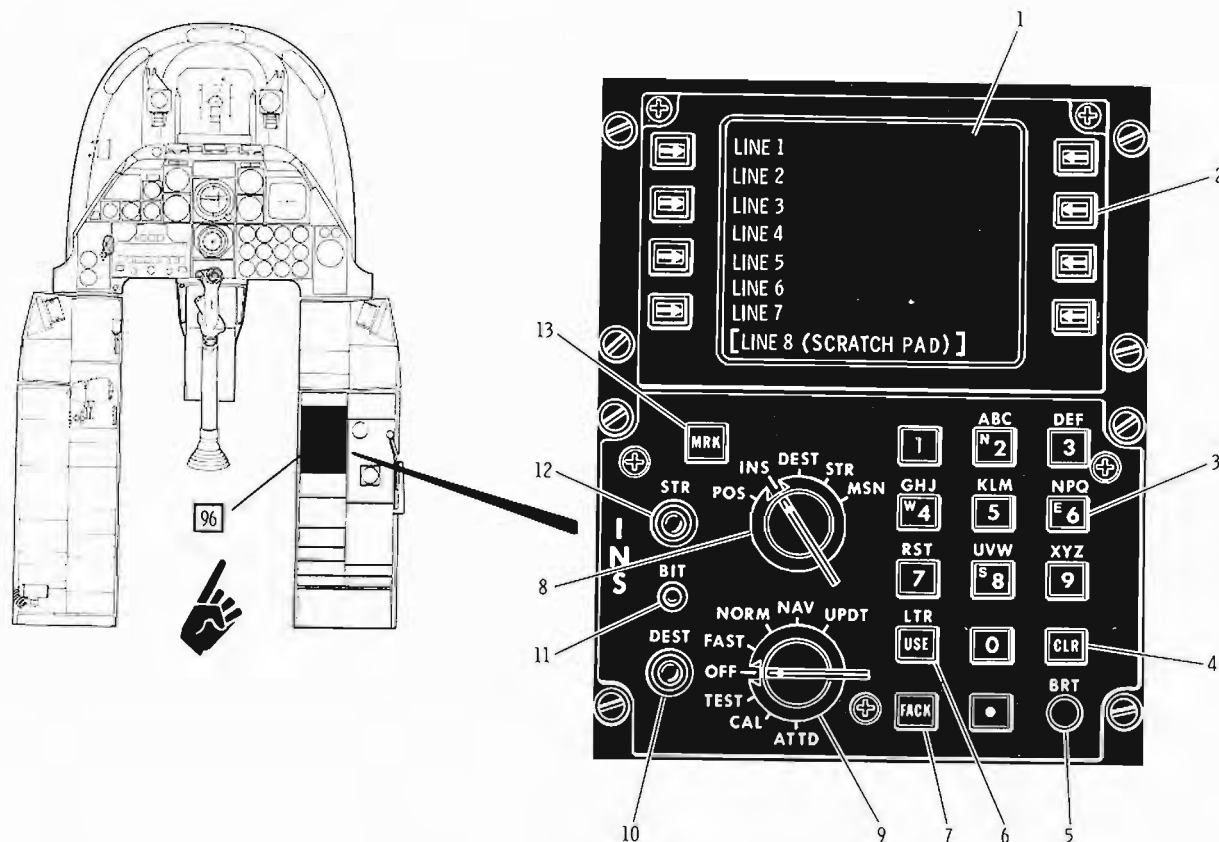

A 1-10A-1-1/8

Index No.	Control or Indicator	Position or Display	Function
1	CRT display	—	Provides for multiple pages of inertial navigation data to be displayed on seven data lines with up to 19 characters per line. One scratch pad occupies the eighth line of the display, with up to 14 enterable characters.
2	Line select keys	—	Eight keys, four on each side of display, when depressed, control data entry and subpage selection.
3	Keyboard pushbuttons	—	Used to insert data into the scratch pad line.

Figure 1-45. (Sheet 1 of 3)

<u>Index No.</u>	<u>Control or Indicator</u>	<u>Position or Display</u>	<u>Function</u>
4	CLR pushbutton	—	Clears scratch pad line. If depressed once, the last inserted character is cleared; if depressed twice, the entire scratch pad line is cleared.
5	BRT control	—	Provides brightness adjustment of CRT display.
6	LTR/USE pushbutton	—	Provides capability for inserting letter characters into the scratch pad line.
7	FACK pushbutton	—	Depressing fault acknowledge (FACK) causes any displayed fault indication to go off and signals system that the fault has been acknowledged.
8	Page selector knob	—	Selects one of five major display pages.
		POS	Selects the position page. See figure 1-46.
		INS	Selects the inertial page. See figure 1-47.
		DEST	Selects the destination page. See figure 1-48.
		STR	Selects the steer page. See figure 1-49.
		MSN	Selects the mission page. See figure 1-50.
9	Mode selector knob	—	Selects INU alignment and operational modes.
		OFF	Removes power from the INU and CDU.
		FAST	INU performs rapid alignment, either stored heading or BATH.
		NORM	INU performs a complete gyro-compass alignment.
		NAV	INU enters primary flight mode of operation.
		UPDT	Provides capability of overfly update of position (figures 1-54 and 1-55).
		Blank Positions (4)	Same as NAV mode.
		TEST	For maintenance purposes only.
		CAL	For maintenance purposes only.
		ATTD	INU initiates attitude reference mode. Navigation information is invalid, but INU continues to provide stable attitude reference to the ADI and HUD, and inertial platform heading reference to the HSI, if NAV CRS or MAN is selected. Once ATTD is selected, NAV cannot be selected.

Figure 1-45. (Sheet 2 of 3)

<u>Index No.</u>	<u>Control or Indicator</u>	<u>Position or Display</u>	<u>Function</u>
10	DEST toggle switch	Left/Right	Used to increase/decrease selected destination (0 - 9, A - F) on line one of display.
11	BIT indicator	White	Indicates a failure in the CDU.
		Black	Indicates no failures in the CDU.
12	STR toggle switch	Up/Down	Used to increase/decrease selected steerpoint (0 - 9, A - F) on line one of display.
13	MRK pushbutton	—	<p>Depressing MRK with mode selector knob set to NAV stores present position as a mark point. Mark point will be stored successively beginning with MARK A. With mode selector knob set to UPDT, the INU initiates position update. Mark points are entered manually, either by depressing the MRK button on the CDU or by depressing the designate switch when airborne. Using one of the last two methods listed, the value of the mark position (PPOS) is automatically inserted into the next available MARK point location. If the next MARK point location is the selected steerpoint, it is not available. In this case, the value of PPOS is inserted into the MARK point location following the selected steerpoint. Examples of MARK point entries:</p> <p>(1) Last MARK point A; current steerpoint C; pilot depressed MARK; PPOS is inserted into MARK point B.</p> <p>(2) Last MARK point B; current steerpoint C; pilot depresses MARK; PPOS is inserted into MARK point D, since C is the steerpoint.</p>
14	Scratchpad	Line 8	Allows data to be keyed in and verified by the operator without disrupting currently displayed data. When satisfied with the data, the operator presses the appropriate line key causing the data to be inserted into the INU and causing the scratchpad to be cleared. The INU transmits the inserted data back to the CDU which displays the data adjacent to the line key pressed.

Figure 1-45. (Sheet 3 of 3)

CDU DISPLAY, POSITION PAGE

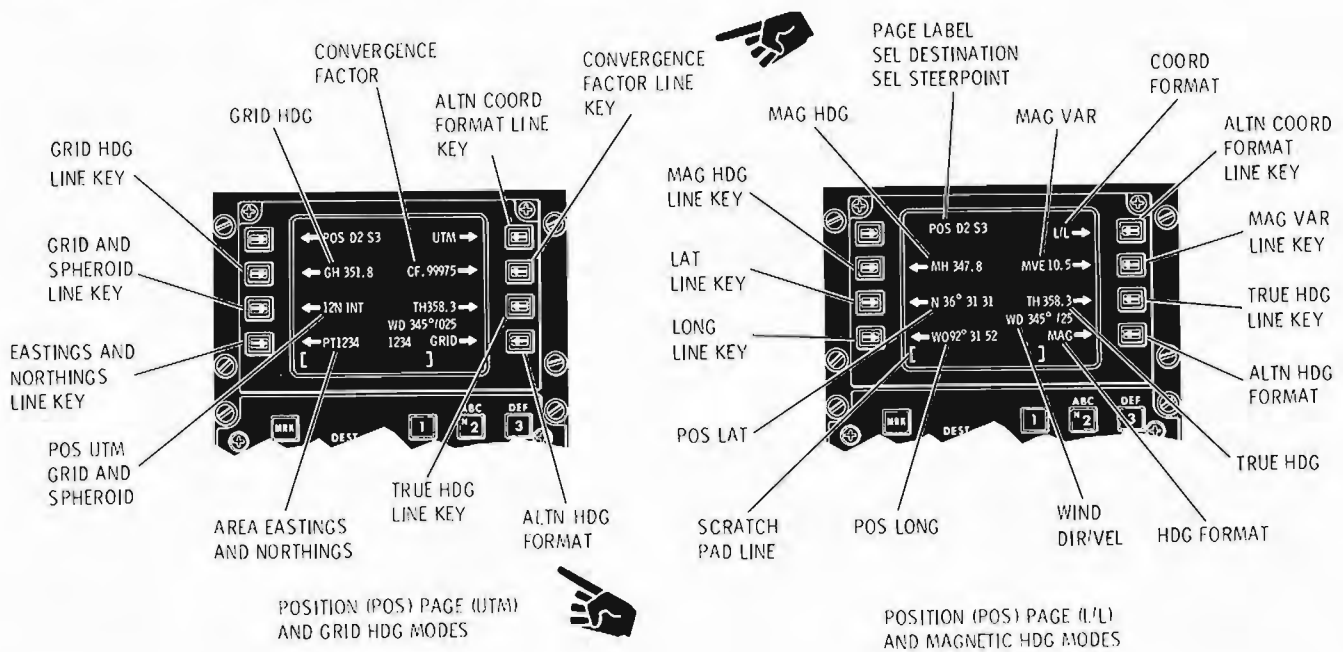

AI-10A-1-20

POSITION PAGE

LABEL/LINE SELECT KEY

FUNCTION

Page label,
Selected destination,
Selected steerpoint/selected mag course

Position page label, selected destination 2, selected steerpoint 3, line select key performs no function. DEST and STR toggle switches increment or decrement selected destination and steerpoint, respectively.

Coordinate format

L/L for latitude/longitude or UTM for universal transverse mercator.

*Alternate coordinate format line key

Allows selection of either L/L or UTM coordinates. Pressing this key when L/L is displayed results in UTM display format.

Magnetic heading line key

Allows entry of magnetic heading from the scratch pad. Entered magnetic heading is accepted only during the first 60 seconds of FAST alignment and results in a BATH alignment.

Grid heading

Grid heading in degrees and tenths. Displayed when grid heading format is selected.

Figure 1-46. (Sheet 1 of 3)

POSITION PAGE

<u>LABEL/LINE SELECT KEY</u>	<u>FUNCTION</u>
Grid heading line key	This key performs no function.
Magnetic variation	Magnetic variation direction in degrees and tenths. At turn-on, value is INU computed. Entered value is indicated by MV. Magnetic variation is computed between 72°N latitude and 60°S latitude.
**Magnetic variation line key	Allows magnetic variation entry from scratchpad (line 8). If the scratchpad is empty when the line key is pressed, the entered value is replaced with the computed value, and is indicated by MV.
Convergence factor	Convergence factor in 5 decimal places. Displayed when the grid heading format is selected.
**Convergence factor line key	Allows convergence factor (up to 5 decimal places) entry from the scratchpad. If a convergence factor is not entered, the INU assumes a value of 1.0.
Position latitude	Present position latitude in degrees, minutes, and seconds.
**Latitude line key	Allows latitude entry from the scratchpad only during the first 2 minutes of gyrocompass alignment or the first 2 minutes of BATH alignment after magnetic or true heading has been entered.
Position longitude	Present position longitude in degrees, minutes, and seconds.
**Longitude line key	Allows longitude entry from the scratchpad only during the first 2 minutes of gyrocompass alignment or the first 2 minutes of BATH alignment after magnetic or true heading has been entered.
Position UTM grid and spheroid	Present position UTM zone of up to two numerics and one alpha character and spheroid model in three alpha or alpha numeric characters.
**Grid and spheroid line key	Allows entry of grid and spheroid codes from the scratchpad.
Area, eastings & northings	Area in two alpha characters, eastings in 4 numbers and northings in 4 numbers indicating tens of meters.
**Eastings & northings line key	Allows UTM eastings and northings to be entered from the scratchpad. Same 2 minute entry limitation for present position LAT/LONG.

Figure 1-46. (Sheet 2 of 3)

POSITION PAGE

<u>LABEL/LINE SELECT KEY</u>	<u>FUNCTION</u>
True heading	True heading in degrees and tenths.
**True heading line key	Allows entry of true headings from the scratchpad. Entered true heading is accepted only during the first 60 seconds of FAST alignment and results in a BATH alignment.
Wind direction/velocity	Wind direction in degrees (magnetic) and velocity in knots.
Heading format	Heading format is in either MAG (magnetic) or GRID.
*Alternate heading format	Allows selection of either MAG or GRID heading formats.

*Denotes change of format or function.
**Denotes an insertable quantity. The small arrows on the display indicate that the corresponding line select key is active. Absence of an arrow indicates that the corresponding line key is inactive.

Figure 1-46. (Sheet 3 of 3)

CDU DISPLAY, INERTIAL PAGE

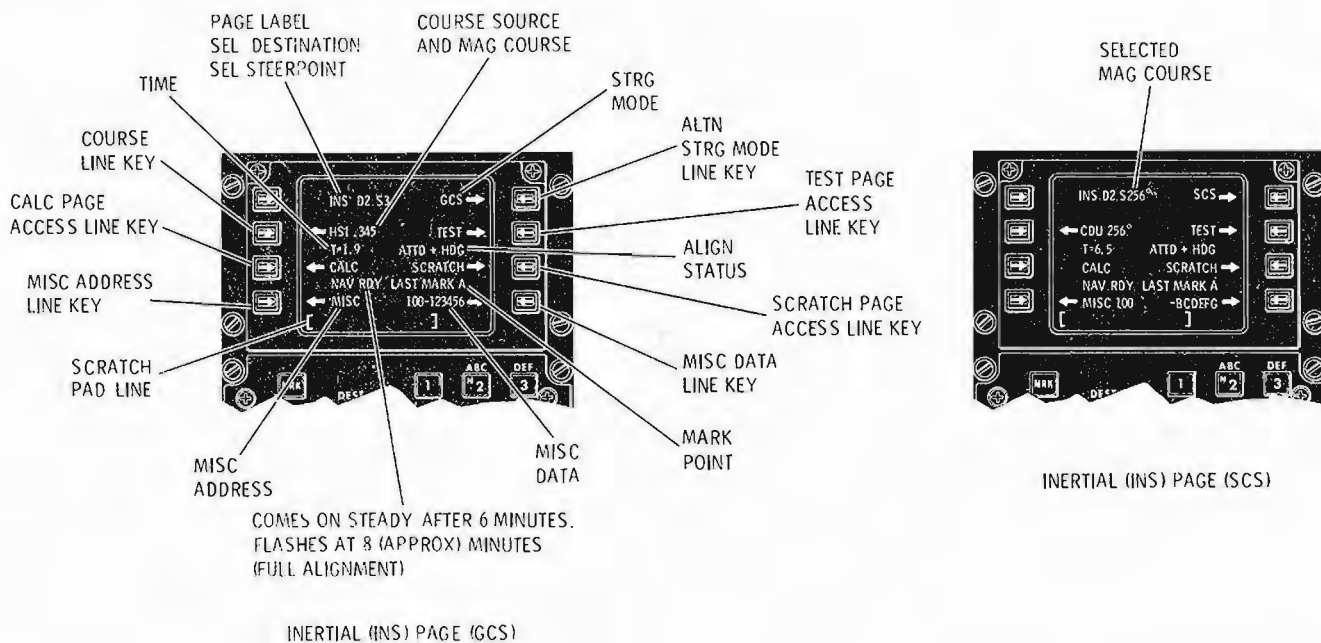

1-10A-1-81

INERTIAL PAGE

LABEL/LINE SELECT KEY

FUNCTION

Page label
 Selected destination
 Selected steerpoint/selected mag course

Inertial page label, selected destination 2, selected steerpoint 3, line select key performs no function. DEST and STR toggle switches increment or decrement selected destination and steerpoint, respectively.

Selected steering mode

GCS directs INU to provide magnetic course to the currently selected steerpoint. SCS directs the INU to navigate along a selected magnetic course as computed from the point of SCS entry.

*Alternate steering mode line key

Allows selection of either GCS or SCS STEERING modes.

Course source and magnetic course

Course source (HSI or CDU) and magnetic course in degrees. HSI course is input via HSI course set knob and is the initial source upon turn on. CDU course is input via scratch pad line entry.

Figure 1-47. (Sheet 1 of 2)

INERTIAL PAGE

<u>LABEL/LINE SELECT KEY</u>	<u>FUNCTION</u>
*Course line key	Allows course entry via the CDU.
**Test page access line key	Allows the operator to access the test page (figure 1-53).
Time	Time INU has been in an align mode (FAST or NORM). Selecting NAV mode freezes align time.
Align status	INU align status. Possible displays are: INIT (initialize) ATTD (attitude available) ATTD + HDG (attitude and heading avail) S = 8.0 - 0.8 relative measure of CEP (circle of error probability).
**Calculator page access line key	Allows the operator to access the calculator page (figure 1-51).
**Scratch page access line key	Allows the operator to access the scratch page (figure 1-52).
Mark point	Mark point location (A - F) in which the last mark was stored. If no mark point has been entered, this line is blank.
Miscellaneous address	INU miscellaneous data address in decimal format.
*Miscellaneous address line key	Allows the operator to enter miscellaneous data addresses from the scratch pad in decimal format.
Miscellaneous data	INU miscellaneous data associated with the miscellaneous address. Up to 6 alphanumeric characters with sign.
*Miscellaneous data line key	Allows the operator to enter the miscellaneous address data in. Primarily for maintenance use.
*Denotes an enterable quantity.	
**Denotes change of format or function.	

Figure 1-47. (Sheet 2 of 2)

CDU DISPLAY, DESTINATION PAGE

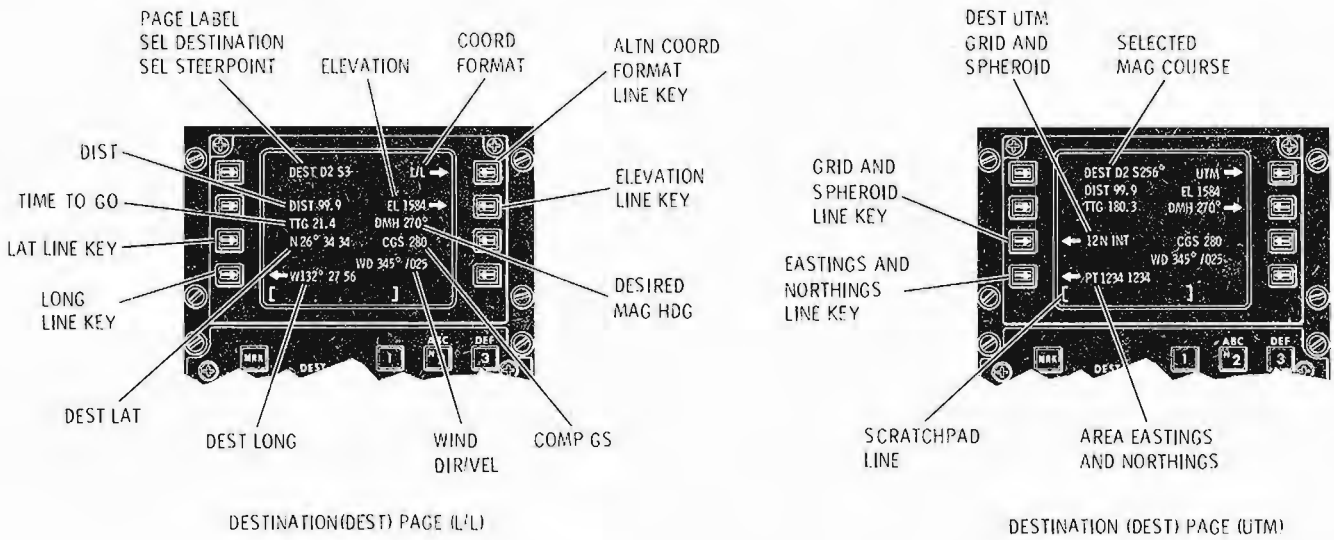

DESTINATION PAGE

LABEL/LINE SELECT KEY

FUNCTION

<p>Page label Selected destination Selected steerpoint</p> <p>Coordinate format</p> <p>*Alternate coordinate format line key</p> <p>Distance</p> <p>Elevation</p> <p>**Elevation line key</p>	<p>Destination page label, selected destination 2, selected steerpoint 3. Line select key performs no function. DEST and STR toggle switches increment or decrement selected destination and steerpoint, respectively.</p> <p>L/L for latitude/longitude or UTM for universal transverse mercator.</p> <p>Allows selection of either L/L or UTM coordinates.</p> <p>Distance to destination in nm and tenths for distances less than 100 nm; whole miles for distances 100 nm or greater.</p> <p>Elevation of destination in feet above sea level.</p> <p>Allows entry of elevation from the scratchpad line ($\pm 32,767$ feet).</p>
---	--

Figure 1-48. (Sheet 1 of 2)

DESTINATION PAGE

<u>LABEL/LINE SELECT KEY</u>	<u>FUNCTION</u>
Time to go	Time to destination in minutes and tenths for times 10 minutes or greater. Times less than 10 minutes are shown in minutes and seconds.
Desired magnetic heading	Desired magnetic heading in degrees (wind corrected) to selected destination.
Destination latitude	Destination latitude in degrees, minutes, seconds.
**Latitude line key	Allows entry of destination latitude.
Destination longitude	Destination longitude in degrees, minutes, seconds.
**Longitude line key	Allows entry of destination longitude.
Destination UTM grid and spheroid	Destination UTM zone of up to 2 numeric and one alpha character and spheroid model in three alpha or alpha numeric characters.
Grid and spheroid line key	Allows entry of grid and spheroid codes from the scratchpad.
Area, eastings & northings	Area in 2 alpha characters, eastings in 4 numbers and northings in 4 numbers indicating tens of meters.
**Eastings & northings line key	Allows UTM eastings & northings to be entered from the scratchpad. Latitude entries for UTM must be less than 80° N or S latitude.
Computed ground speed	Computed (predicted) ground speed in knots to selected destination. Based on last computed wind, assuming present true airspeed remains constant.
Wind direction/velocity	Wind direction in degrees and velocity in knots.
*Denotes change of format or function.	
**Denotes an enterable quantity.	

Figure 1-48. (Sheet 2 of 2)

CDU DISPLAY, STEER PAGE

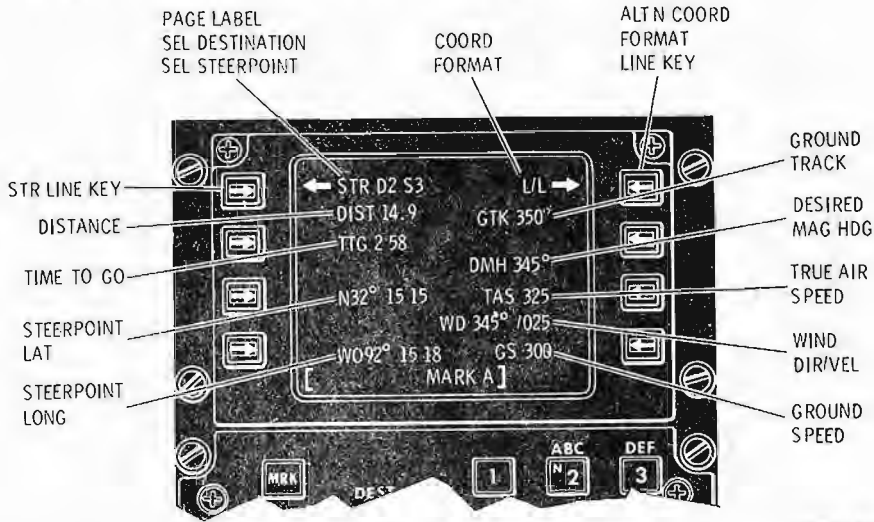

STEER (STR) PAGE (L/L)
GREAT CIRCLE STEERING (GCS)

SELECTED MAGNETIC COURSE

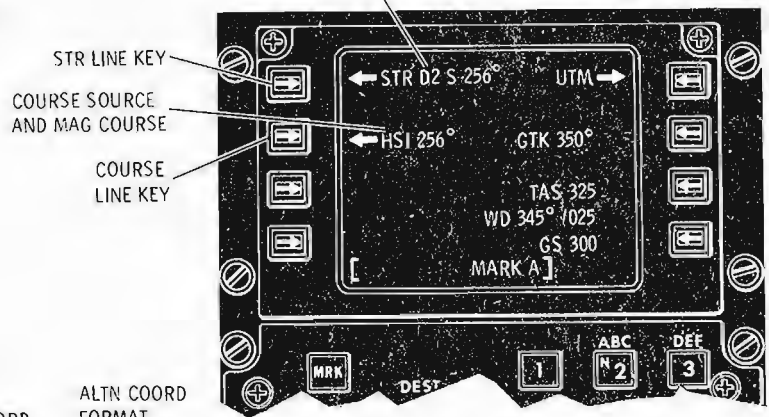

STEER (STR) PAGE (UTM)
SELECTED COURSE STEERING (SCS)

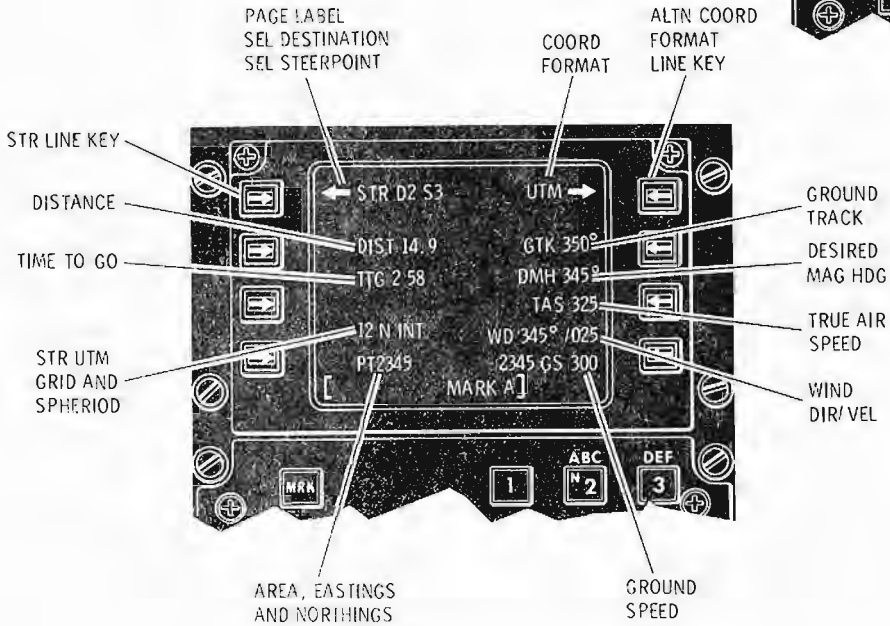

STEER (STR) PAGE UTM
GREAT CIRCLE STEERING (GCS)

1-10A-1-83

Figure 1-49. (Sheet 1 of 2)

STEER PAGE

<u>LABEL/LINE SELECT KEY</u>	<u>FUNCTION</u>
Page label	Steer page label, selected destination 2, Selected steerpoint 3;
Selected destination	Line select key performs no function. DEST and STR toggle
Selected steerpoint	switches increment or decrement selected destination and steerpoint, respectively.
*Steerpoint line key	Allows operator to select marked position (A – F in scratchpad) as new steerpoint; selection clears the scratchpad. If marked position is selected as steerpoint, GCS steering mode will automatically be selected.
Coordinate format	L/L for latitude/longitude or UTM for universal transverse mercator.
**Alternate coordinate format line key	Allows selection of either L/L or UTM coordinates.
***Distance	Distance to steerpoint in nm and tenths for distances less than 100 nm. Whole nm for distances 100 nm or greater.
Ground track	Aircraft magnetic ground track in degrees.
***Time-to-go	Time to steerpoint assuming constant velocity. Less than 10 minutes shown in minutes and seconds; greater than 10 minutes is shown in minutes and tenths.
Desired magnetic heading	Desired magnetic heading (wind corrected) to the steerpoint in degrees.
***Steerpoint latitude	Steerpoint latitude in degrees, minutes and seconds.
***Steerpoint longitude	Steerpoint longitude in degrees, minutes, and seconds.
***Steerpoint UTM grid and spheroid	Steerpoint UTM zone of up to 2 numeric and one alpha character and spheroid model in three alpha characters.
***Arca, eastings and northings	Area in 2 alpha characters, eastings in 4 numbers and northings in 4 numbers indicating tens of meters.
True airspeed	True airspeed in knots.
Course source and mag course	Same as INS page, displayed on STR page only if SCS steering mode selected on INS page.
Wind direction/velocity	Magnetic wind directions in degrees and velocity in knots.
Ground speed	Ground speed in knots.
*Denotes an enterable quantity	
**Denotes change of format or function.	
***Denotes data not displayed if SCS steering mode selected on INS page.	

Figure 1-49. (Sheet 2 of 2)

CDU DISPLAY, MISSION PAGE

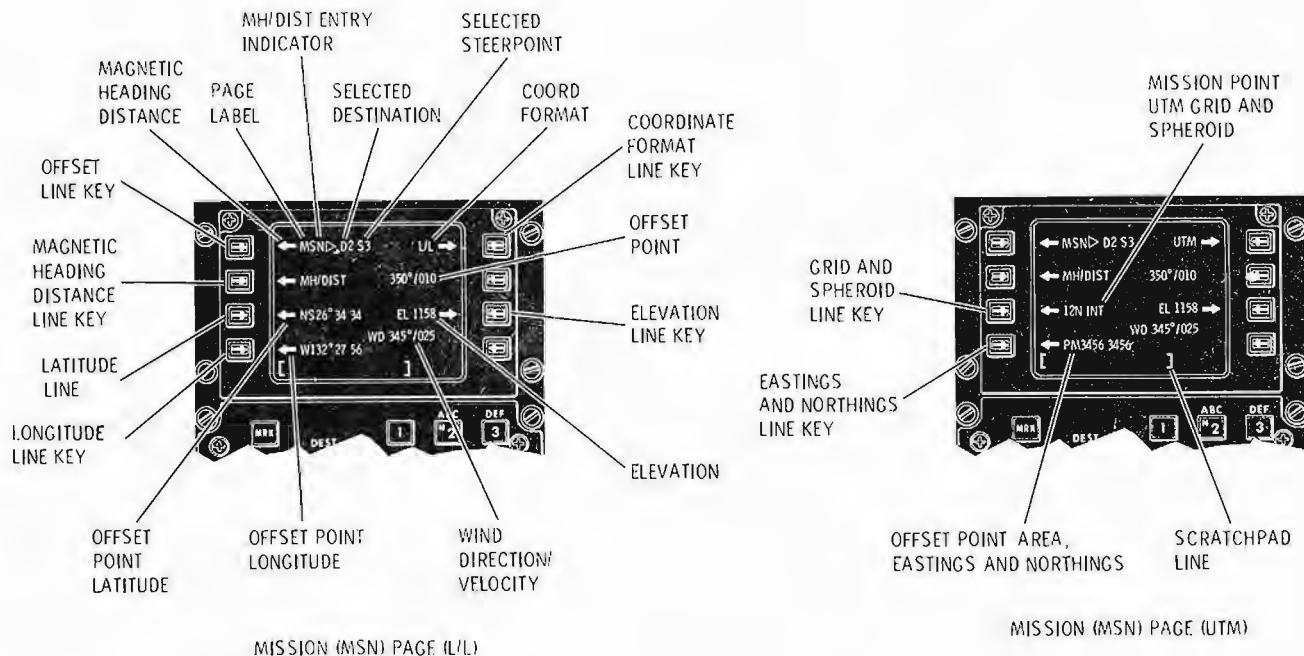

MISSION PAGE

LABEL/LINE SELECT KEY

FUNCTION

Page label
 Selected destination
 Selected steerpoint

Mission page label. Mission is from selected destination 2, selected steerpoint 3. Line select key performs no function. DEST and STR toggle switches increment or decrement selected destination and steerpoint, respectively.

MH/DIST entry indicator

Indicates last entry on MSN page was MH/DIST and will not appear when L/L-UTM coordinates are entered.

Offset line key

Allows entry of offset point as selected steerpoint. Offset point is selectable as steerpoint only after offset point bearing and distance or coordinates (L/L-UTM) are entered and arrow appears on page label line. If the offset point is selected as steerpoint, GCS steering mode will automatically be selected.

Coordinate format

L/L for latitude/longitude or UTM for universal transverse mercator.

*Alternate coordinate format line key

Allows selection of either L/L or UTM coordinates.

Figure 1-50. (Sheet 1 of 2)

MISSION PAGE

<u>LABEL/LINE SELECT KEY</u>	<u>FUNCTION</u>
Offset point magnetic heading distance	Heading is in whole degrees; distance is nm from selected destination to offset point.
**Magnetic heading/distance line key	Allows entry of heading and distance to a selected destination from scratchpad line. When this data is entered, computed offset point coordinates (L/L-UTM) appear in lines 5 and 7.
**Offset point UTM grid and spheroid	Offset point UTM zone of up to 2 numeric and one alpha character and spheroid model in three alpha characters.
**Grid and spheroid line key	Allows entry of grid and spheroid codes from scratchpad line. When entered along with area, eastings, northings, a magnetic heading and distance in nm from the selected destination to the offset point will be computed and displayed.
**Elevation	Elevation of offset point in feet. Pilot reference only and does not affect INU computations.
**Elevation line key	Allows entry of elevation from scratchpad line. Must be entered after offset point coordinates are entered/computed ($\pm 32,767$ feet).
Wind direction/velocity	Wind direction in degrees and velocity in knots.
**Area, eastings and northings	Area in 2 alpha characters, eastings in 4 numbers and northings in 4 numbers indicating tens of meters. Latitude entries for UTM must be less than 80° N or S latitude.
Eastings and northings line key	Allows entry of offset point eastings and northings from scratchpad line. When entered with UTM grid and spheroid model number, a magnetic heading and distance (nm) from the selected destination to the offset point will be computed and displayed in line 3.
Offset point latitude	Offset point latitude in degrees, minutes, seconds.
**Latitude line key	Allows entry of offset point latitude. When entered with longitude, a magnetic heading and distance (nm) from the selected destination to offset point will be computed and displayed in line 3.
Offset point longitude	Offset point longitude in degrees, minutes, seconds.
**Longitude line key	Allows entry of offset point longitude. When entered with latitude, a magnetic heading and distance from the selected destination to the offset point will be computed and displayed in line 3.

*Denotes change of format or function.

**Denotes an enterable quantity.

Figure 1-50. (Sheet 2 of 2)

CDU DISPLAY, CALCULATOR PAGE

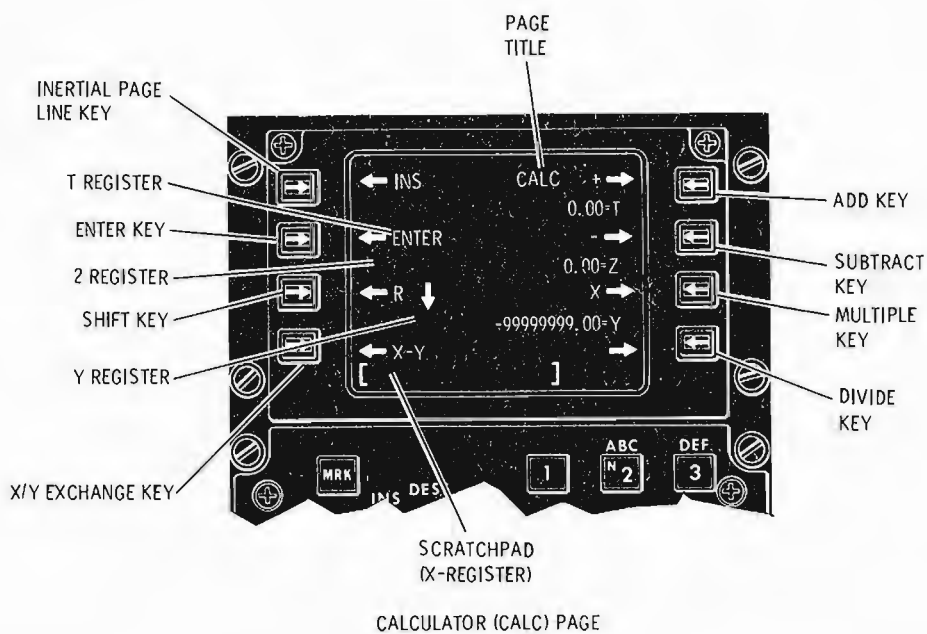

1-10A-1-86

CALCULATOR PAGE

<u>LABEL/LINE SELECT KEY</u>	<u>FUNCTION</u>
Inertial page line key	Allows return to INS page.
Page title	Calculator page title.
Add key	Performs addition. Adds X and Y registers.
T register	Fourth register.
Enter key	Enters data from X register (scratchpad line) to Y register. Pushes contents of Y to Z register, contents of Z to T register and contents of T register are lost.

Figure 1-51. (Sheet 1 of 2)

CALCULATOR PAGE

<u>LABEL/LINE SELECT KEY</u>	<u>FUNCTION</u>
Subtract key	Performs subtraction. Subtracts X register from Y register.
Z register	Third register.
Shift key	Enters data from X register into T register. Pushes T register contents to Z, Z contents to Y and Y contents to X.
Multiply key	Performs multiplication. Multiplies X register by Y register.
Y register	Second register.
X/Y exchange key	Performs an exchange of contents of X register and Y register.
Divide key	Performs division. Y register is divided by X register.
Scratchpad line (X register)	The first and active register.

Figure 1-51. (Sheet 2 of 2)

CDU DISPLAY, SCRATCH PAGE

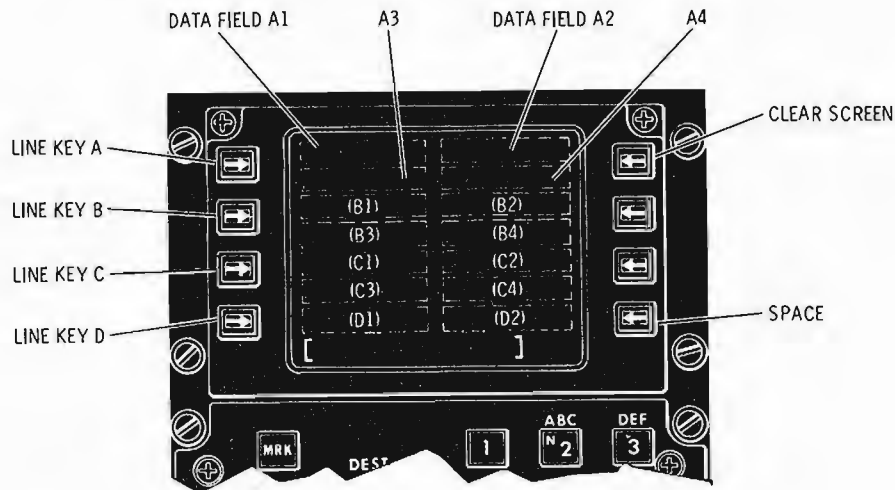

1-10A-1-87

SCRATCH PAGE

LABEL/LINE SELECT KEY

FUNCTION

Line key A	Enters scratchpad line contents (line 8) into next available data field, A1, A2, A3, or A4. On initial access after power up, scratch page is blank and next available data field is A1. If A1, A2, A3, and A4 contain data, next entry in A field will be written into A1 and former data in A1 is lost. If line key is pressed with scratchpad line empty, blanks are written into next available data field.
Data fields A1, A2, A3 and A4	Nine and ten character data fields; ten on left side of screen, nine on right side.
Line keys B, C, and D	Function the same as line key A with their respective data fields, except D is limited to two data fields (D1, D2).
Data fields B1, B2, B3, B4, C1, C2, C3, C4, D1, and D2	Nine and ten character data fields which correspond to line keys B, C and D.
Clear screen	Allows clearing of entire screen. Next available data fields are A1, B1, C1, and D1.
Space	Allows entry of a space in the scratchpad line.

Figure 1-52

CDU DISPLAY, TEST PAGE

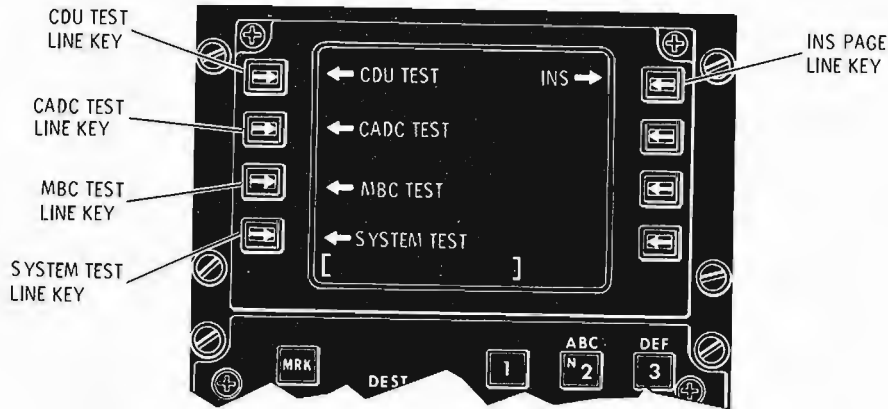

1-10A-1-88

TEST PAGE

LABEL/LINE SELECT KEY

FUNCTION

CDU test line key
 CADC test line key
 MBC test line key
 System test line key
 INS page line key

Initiates CDU self-test.
 Initiates CADC self-test.
 Initiates MBC self-test.
 Not operable.
 Allows return to INS page.

CDU Test

Pressing the line key adjacent to CDU TEST on the test page initiates an internal CDU test. Upon actuation, the INERTIAL NAV caution light comes on with the mode selector in NAV or UPDT, or the light goes off with the mode selector in FAST or NORM, and the CDU BIT indicator sets white. CDU TEST on line one is replaced by CDU GO or CDU NO GO. After approximately 5 seconds, the CDU BIT indicator resets black, CDU GO or CDU NO GO changes back to CDU TEST, and the INERTIAL NAV caution light goes off with the mode selector in NAV or UPDT, or comes back on with the mode selector in FAST or NORM. The unit has failed if CDU NO GO appears and/or the BIT indicator does not reset.

MBC Test

Pressing the line key adjacent to MBC TEST on the test page initiates a test of the MBC. Upon actuation, the MBC fail annunciation will appear on line 2 of the display indicating that the test is in progress. After 3 seconds the annunciation will extinguish indicating that tests are complete and the unit is go. If the annunciation fails to extinguish, the unit has failed its tests and may be unreliable. Pressing FACK will erase MBC; further test of the MBC will not indicate MBC failure.

CADC Test

Pressing the line key adjacent to CADC TEST on the test page initiates a test of the CADC. Upon actuation, the CADC and VV annunciation will appear on line 2 of the display indicating that the test is in progress. After 3 seconds the annunciation will extinguish indicating that tests are complete and the unit is go. If the annunciation fails to extinguish, the unit has failed its tests and is no go.

Figure 1-53

CDU DISPLAY, UPDATE PAGE

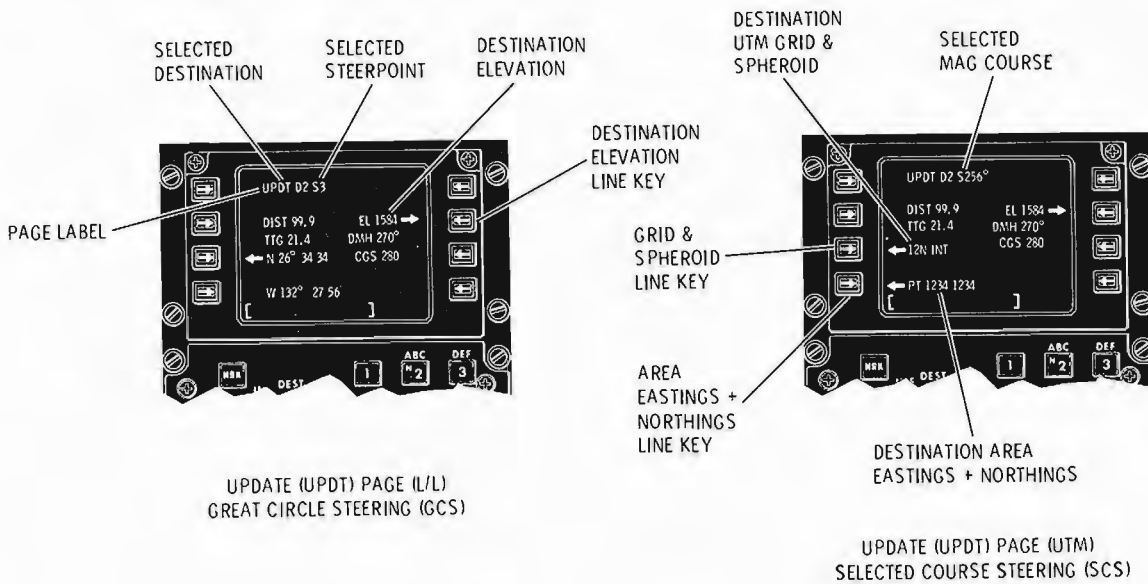

1-10A-1-89

UPDATE PAGE

LABEL/LINE SELECT KEY

Page label
 Selected destination
 Selected steerpoint/selected magnetic course

Distance

Elevation

*Elevation line key

Time to go

Desired magnetic heading

FUNCTION

Update page label. Selected destination and selected steerpoint selected magnetic course. Line select key performs no function. DEST and STR toggle switches increment or decrement selected destination and steerpoint, respectively.

Distance to destination in nm and tenths for distances less than 100 nm; whole miles for distances 100 nm or greater.

Elevation of destination in feet.

Allows entry of elevation from the scratchpad line ($\pm 32,767$ feet).

Time to destination in minutes and tenths for times 10 minutes or greater. Times less than 10 minutes are shown in minutes and seconds.

Desired magnetic heading in degrees (wind corrected) to selected destination.

Figure 1-54. (Sheet 1 of 2)

UPDATE PAGE

<u>LABEL/LINE SELECT KEY</u>	<u>FUNCTION</u>
Destination latitude	Destination latitude in degrees, minutes, seconds.
*Latitude line key	Allows entry of destination latitude.
Destination longitude	Destination longitude in degrees, minutes, seconds.
*Longitude line key	Allows entry of destination longitude.
Destination UTM grid and spheroid	Destination UTM zone of up to 2 numeric and one alpha character, and spheroid model in three alpha or alphanumeric characters.
*Grid and spheroid line key	Allows entry of grid and spheroid codes from the scratchpad.
Area, eastings & northings	Area in 2 alpha characters, eastings in 4 numbers and northings in 4 numbers indicating tens of meters.
*Eastings & northings line key	Allows UTM eastings & northings to be entered from the scratchpad.
Computed ground speed	Computed (predicted) ground speed in knots to selected destination. Based on last computed wind, assuming present true airspeed remains constant.
Wind direction/velocity	Wind direction in degrees and velocity in knots.
*Denotes an enterable quantity.	

Figure 1-54. (Sheet 2 of 2)

CDU DISPLAY, ACCEPT/REJECT PAGE

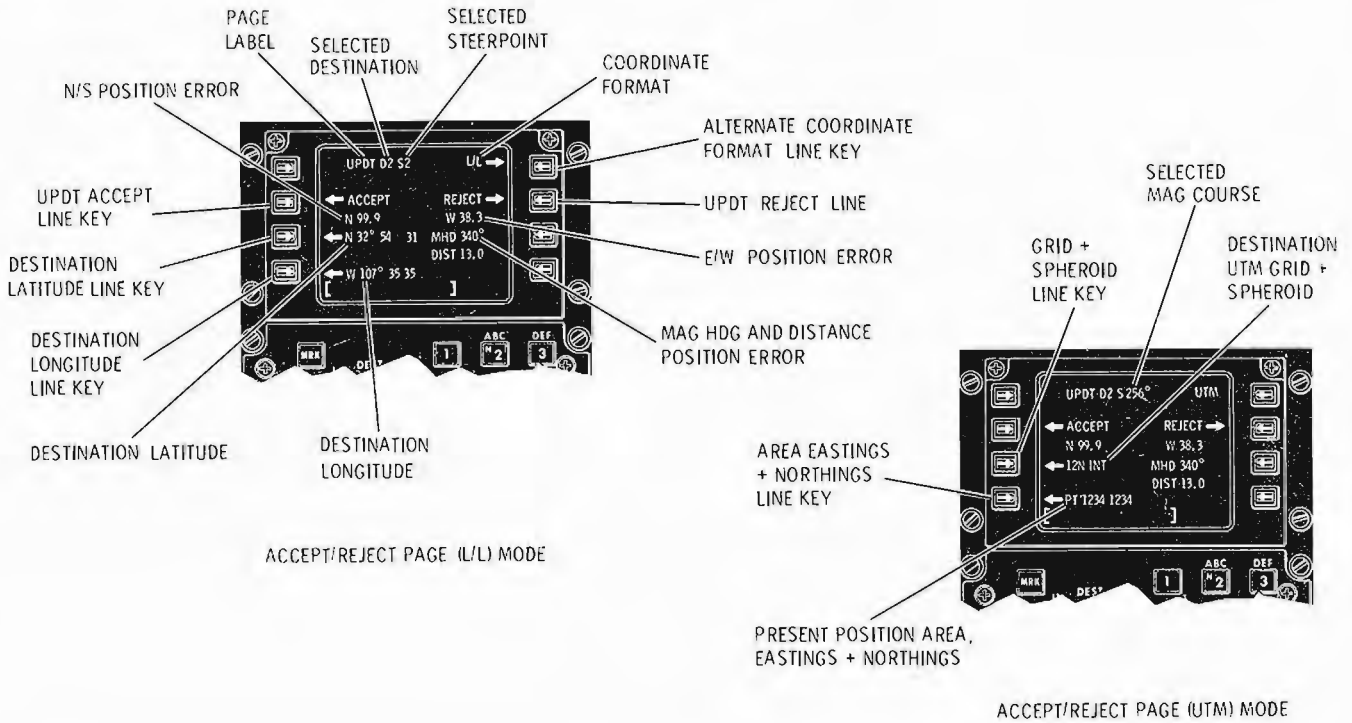

1-10A-1-90

UPDATE/ACCEPT-REJECT PAGE

LABEL/LINE SELECT KEY

FUNCTION

- Page label
- Selected destination
- Selected steerpoint/selected magnetic course
- Coordinate format
- *Alternate coordinate format line key
- *Update reject line key
- *Update accept line key
- N/S position error

- Update page label. Selected destination and selected steerpoint/selected magnetic course. Line select key performs no function. DEST and STR toggle switches increment or decrement selected destination and steerpoint, respectively.
- L/L for latitude/longitude or UTM for universal transverse mercator.
- Allows selection of either L/L or UTM coordinates. Pressing this key when L/L is displayed results in the display format in figure 1-45 (bottom) and vice-versa.
- Rejects overfly position update.
- Accepts overfly position update.
- Position update error north or south in nm.

Figure 1-55. (Sheet 1 of 2)

UPDATE/ACCEPT-REJECT PAGE

<u>LABEL/LINE SELECT KEY</u>	<u>FUNCTION</u>
E/W position error	Position update error east or west in nm.
Magnetic heading and distance position error	Position update error in magnetic heading and distance in nm.
Destination latitude	Destination latitude in degrees, minutes, and seconds.
**Destination latitude line key	Allows entry of destination latitude.
Destination longitude	Destination longitude in degrees, minutes, and seconds.
**Destination longitude line key	Allows entry of destination longitude.
Destination UTM grid and spheroid	Destination UTM zone of up to two numeric and one alpha character, and spheroid model in three alpha characters.
**Destination UTM grid and spheroid line key	Allow entry of destination grid and spheroid from the scratchpad.
Area, eastings & northings	Area in 2 alpha characters, eastings in 4 numbers and northings in 4 numbers indicating tens of meters.
**Eastings & northings line key	Allows UTM eastings & northings to be entered from the scratchpad.
*Denotes change in function or format.	
**Denotes an enterable quantity.	

Figure 1-55. (Sheet 2 of 2)

General Rules for Error Checking

Although error messages are an essential part of CDU operation, certain errors are not noted. Some general rules of operation along this line are as follows:

1. If a line key is pressed that performs no operation, no error message is given. For instance, on the destination page (DEST), if longitude is entered and the key adjacent to time-to-go is pressed, no error message appears.
2. Leading and trailing zeros and decimal points are not required unless the value is ambiguous without them. For instance, if 30° is entered as a latitude, the CDU enters 30°00'00".
3. If an illegal entry is made because the wrong line select key is pressed, it is entered and accepted by pressing the correct key. For instance, entering 125° as a latitude is an error; however, by pressing the line select next to longitude, the error is removed and the value used.

ALIGNMENT MODES

Normal and fast are the two alignment modes available in the INS. There is no capability for an inflight alignment. Alignment time is dependent on ambient temperature and type of alignment (see figure 1-56).

Full alignment is indicated by a flashing NAV RDY on the CDU. A degraded alignment in any mode is indicated when NAV RDY illuminates steady.

If an alignment is terminated or if the CDU is turned off, wait 30 seconds prior to beginning another alignment.

Normal Alignment

Normal alignment, also called gyrocompass alignment, provides the most accurate navigational data. The INU is designed to not more than 0.8 nm/hour CEP for the first hour and 1 nm/hour CEP for flights longer than 1 hour.

The degraded method of normal alignment (after NAV RDY indication on steady, approximately 6 minutes) provides navigational accuracy of 5 – 8 nm/hour CEP.

Fast Alignment

Stored heading and BATH are the two submodes of fast alignment. Either method provides a rapid means of aligning the INS; however, navigational accuracy is less than when using a normal alignment.

A stored heading alignment uses the heading derived by the INU as described in the Normal Alignment/Cocking Procedure, in this section. Using this procedure, the INS is allowed to complete a full normal alignment (CDU mode selector knob in NORM) and is switched off without ever going to NAV. The aircraft should not be moved nor should the INS be on again after the aircraft is cocked. When FAST align is subsequently selected, the INS retains all data from the previous NORM alignment. The resulting stored heading alignment produces accuracies of 3 nm/hour CEP for the full FAST alignment or 5 – 8 nm/hour CEP in the degraded mode.

A BATH alignment uses either a heading given to the INU by the pilot or the heading last stored in the INU memory. BATH alignment is dependent on the accuracy of the heading used. A BATH alignment is complete when NAV RDY illuminates steady.

INS OPERATIONS

Geographical Data Entry

To enter data into the CDU in the L/L format, proceed as follows:

1. CDU page selector knob — POS, DEST, or MSN, as required.

NOTE

- L/L data may be entered with the CDU mode selector knob in UPDT. UPDT page will appear regardless of CDU page selector knob position.

2. Keyboard pushbuttons — Depress for desired alphanumeric latitude readout on scratchpad.

NOTE

- If previous entry was same hemisphere (N or S), that letter need not be entered.

T.O. 1A-10A-1

3. CDU latitude line select key — Depress to enter.

4. Keyboard pushbuttons — Depress for desired longitude readout on scratchpad.

NOTE

- If previous entry was same hemisphere (E or W) , that letter need not be entered on the scratchpad.

5. CDU longitude line select key — Depress to enter.

To enter data into the CDU in the UTM format, proceed as follows:

1. CDU page selector knob — POS, DEST, or MSN, as required.

NOTE

- UTM data may be entered with the CDU mode selector knob in UPDT. UPDT page will appear regardless of CDU page selector knob position.

2. Keyboard pushbuttons — Enter required grid zone and spheroid on scratchpad line. Grid zone entries consist of one or two numerics followed by an alpha character. Spheroid model entries consist of a numeric code from 0 - 10 according to spheroid table. Grid zone and spheroid can be entered separately if desired.

3. CDU grid and spheroid line select key — Depress to enter.

4. Keyboard pushbuttons — Depress for desired area, eastings, and northings readout on scratchpad line. An even number of numerics up to 10 can be entered for eastings and northings in the scratchpad line; trailing zeroes will be automatically added by the CDU, if required.

NOTE

- If previous entry has same UTM alpha area, that area need not be entered.

5. CDU area, eastings, and northings line select key — Depress to enter.

NOTE

- A maximum of eight numerics will be displayed in the UTM eastings and northings.

Normal Alignment/Cocking Procedure

NOTE

- The aircraft should not be moved until alignment is completed. Before the aircraft is moved, the mode selector knob must be in the NAV mode. If the aircraft is moved, a realignment is necessary after a minimum shutdown period of 30 seconds.

1. CDU mode selector knob — NORM. CDU will take 20 - 30 seconds before display appears.

2. CDU page selector knob — POS.

<u>CODE</u>	<u>SPHEROID MODEL</u>	<u>CDU LINE 5 DISPLAY</u>
0	International	INT
1	Clark 1866	CL6
2	Clark 1880	CL0
3	Everest	EVR
4	Bessel	BSL
5	Australian National	AUS
6	Airy	ARY
7	Hough	HGH
8	South American	SAM
9	Modified Everest	MEV
10	WGS-72	WGS

3. CDU keyboard pushbuttons — Enter present position (L/L-UTM) within 2 minutes of selecting NORM.

NOTE

- Spheroid model used for destination coordinate entry should be the same as spheroid model used for present position entry.
- Failure to enter present position within the first 2 minutes after selecting NORM will cause the system to align to previously stored coordinates and may result in poor navigation performance. When present position is not entered, the CDU align status display will alternately flash between INIT and the achieved align status. Align status will not decrement below $S = 3.2$ and the NAV RDY annunciator will not flash. When $S = 3.2$ is achieved, the INS is ready to navigate, but degraded performance is probable (actual performance depends on proximity of stored position used to the actual position, and could be better or worse than 3.2 NM/hour).
- If there is a power interruption of more than 1.5 seconds to INS, CDU screen will go blank for approximately 30 seconds.
- Destination 0 will automatically be loaded with the present position when present position is entered during normal alignment. This occurs whether using L/L or UTM coordinates. If desired, destination 0 can be reprogrammed after the present position is entered.

4. CDU page selector knob — DEST, as required.

5. Destination toggle switch — Select destinations and enter as required.

Observe NAV RDY indication (CRT display line 6) on steady after 6 minutes and flashing at 8 - 12 minutes.

6. CDU mode selector switch — As desired.

a. OFF if cocking INS for future stored heading alignment.

b. NAV prior to taxi.

Stored Heading Alignment (FAST)

NOTE

- The aircraft must not have been moved or INS maintenance performed subsequent to the cocking procedure, as navigation data will be unreliable.

1. CDU mode selector knob — FAST. CDU will take 20 - 30 seconds before display appears.

NOTE

- Entry of magnetic or true heading during stored heading alignment will cause the INS to revert to a BATH alignment.

2. Enter destinations, as required.

Observe NAV RDY indication (CRT display line 6) flashing at 1.5 - 4.0 minutes.

NOTE

- At temperatures below -17°C , NAV RDY will come on steady after 2.0 minutes indicating a degraded navigation capability is available. See figure 1-56 for alignment time versus temperature chart.

3. CDU mode selector knob — NAV.

BATH Alignment (FAST)

1. CDU mode selector knob — FAST. CDU will take 20 - 30 seconds before display appears.

2. CDU page selector knob — POS.

3. CDU keyboard pushbuttons — Enter magnetic or true heading, if desired.

a. If aircraft has not been moved or INS maintenance performed subsequent to INS shutdown from NAV mode, heading entry is not required. System will align to previous true heading at shutdown.

ALIGNMENT TIME VS. TEMPERATURE

	NORMAL			FAST					
	-40°C	-17°C	21°C	STORED HEADING			BATH		
				-40°C	-17°C	21°C	-40°C	-17°C	21°C
FULL ACCURACY	12 Min.	9 Min.	8 Min.	4 Min.	2.5 Min.	1.5 Min.	—	—	—
DEGRADED ACCURACY	6 Min.	6 Min.	6 Min.	2 Min.	2 Min.	—	2 Min.	2 Min.	1.5 Min.

Figure I-56.

b. If aircraft has been moved or INS maintenance performed, magnetic or true heading must be entered within 1 minute of turn-on. Navigation quality is dependent upon the accuracy of the heading entered.

4. CDU keyboard pushbuttons — Enter present position.

NOTE

- Present position must be entered within 2 minutes and prior to selection of NAV.
- Failure to enter present position will cause INS to align to previously stored coordinates and may result in poor navigation performance. When present position is not entered, the align status display will alternately flash between INIT and the achieved align status. The achieved align status will not decrement to below $S = 2.4$.

5. Enter destinations; if required.

Observe NAV RDY indication (CRT display line 6) steady at 1.5 – 2.0 minutes.

6. CDU mode selector knob — NAV.

NOTE

NAV RDY will not flash after completion of a BATH alignment.

CADC Test

1. CDU page selector knob — INS.
2. Test page line select key — Depress.
3. CADC test line select key — Depress.
4. Observe that CADC does not remain on line 2 of display, and 5,000 feet altitude and 300 knots calibrated airspeed appear on the HUD (HUD must be in any mode except OFF and TEST).
5. If CADC remains on line 2, maintenance is required.

MBC Test

1. CDU page selector knob — INS.
2. Test page line select key — Depress.
3. MBC test line select key — Depress.
4. Observe MBC appears on line 2 of display for approximately 3 seconds and then goes off, indicating MBC and the data bus are good.
5. If MBC appears on line 2 steady, maintenance is required.

CDU Test

1. CDU page selector knob — INS.
2. Test page line select key — Depress.
3. CDU test button — Depress.

4. Line 1 of display TEST word changes to GO, CDU fault indicator is set and INS caution lamp is illuminated. After approximately 3 seconds caution lamp extinguishes, fault indicator resets, and word GO is replaced by TEST.

5. If NO GO appears and/or the fault indicator does not reset, maintenance is required.

Mark Function

1. CDU mode selector knob — NAV.

2. INS mark button on control stick or CDU MRK pushbutton — Depress at flyover. Position is stored and scratchpad line will display MARK A - F, corresponding to last mark point.

If mark point is to be used as a steerpoint:

3. CDU page selector knob — STR.

4. CDU steerpoint line select key — Depress. Mark point becomes steerpoint; scratchpad line will clear.

If mark point is not to be used as a steerpoint.

3. CDU CLR pushbutton — Depress. Scratchpad line clears.

NOTE

- There are 6 mark points available. If more than 6 mark functions are utilized, the original data will be replaced. For example, if 7 points are utilized the original data in A will be replaced. Any offset data entry on MSN page utilizes a mark point.
- If using the UTM mode, the correct spheroid model for the mission area should be entered into mark points A - F when entering destination coordinates (0 - 9). Otherwise, the new mark points may be located in an undesirable spheroid (the spheroid contained in INU memory at shutdown).

Offset Point Computations

Offset point computations are made when either the magnetic heading and distance or the coordinates (L/L-UTM) of an offset point from a selected destination are given. Given the magnetic heading and distance (nm) from a selected destination, the CDU will compute the offset point coordinates and store the coordinates in destination location A, B, C, D, E, or F. If coordinates of the offset point are given (L/L-UTM), the CDU will compute the magnetic heading and distance from the selected destination to the offset point. The destination locations are used for storing offset points in the sequence A, B, C, D, E, F, A, B, etc. To perform offset point computations, proceed as follows:

If offset coordinates are given:

1. CDU mode selector knob — NAV.

2. CDU page selector knob — MSN.

3. Destination toggle switch — Select desired destination.

4. CDU keyboard pushbuttons — Enter L/L or UTM coordinates. Observe magnetic heading and distance from selected destination to offset point.

5. Offset line key — Depress after arrow appears on page label line, if offset point is desired as immediate steerpoint.

If magnetic heading and distance to offset point are given:

1. CDU mode selector knob — NAV.

2. CDU page selector knob — MSN.

3. Destination toggle switch — Select desired destination.

4. CDU keyboard pushbuttons — Enter magnetic heading and distance. Observe offset point coordinates (L/L-UTM).

5. Offset line key — Depress after arrow appears on page label line, if offset point is desired as immediate steerpoint.

Position Flyover Update

To update position using the overfly method, proceed as follows:

1. CDU mode selector knob — UPDT. Update page is displayed.
2. Destination toggle switch — Select proper destination.
3. INS mark button on control stick or CDU MRK pushbutton — Depress at flyover. Update accept/reject page is displayed.

NOTE

- Destination selected can be changed after update is initiated and prior to accept/reject decision. The INU computes update position errors based on any selected destination.
 - The operator should insure that the selected destination coordinates (L/L or UTM) on which the update is performed are correct prior to accepting the position update.
4. CDU accept or reject line keys — Depress, as desired.

If update is to be entered in INU: Accept line select key — Depress.

If update is not to be entered in INU: Reject line select key — Depress.

Access to Miscellaneous Data

To access miscellaneous data, proceed as follows:

1. CDU page selector knob — INS.
2. CDU keyboard pushbuttons — Depress for desired miscellaneous data address. Address appears in scratchpad line.
3. Miscellaneous address line select key — Depress. Address appears on miscellaneous address line. Corresponding miscellaneous data is displayed following address.

Terminal Error Update

Provides a history of navigation performance, which is stored in the INU. To perform a terminal update, proceed as follows:

1. CDU page selector knob — DEST.
2. DEST toggle switch — Select terminal destination.

NOTE

- Destination selected must contain the geographic coordinates of the aircraft's location at the time the terminal update is performed.

3. CDU page selector knob — INS.
4. CDU keyboard pushbutton — Enter 19.
5. Miscellaneous address line select key — Depress.

MISC 019 appears in miscellaneous address line on left and RER X.X appears on right. (X.X is RER in nautical miles per hour.)

NOTE

- RER 9.9 will appear when RER equals or exceeds 9.9 NM/HR.
- RER NA will appear if:
 - BATH, stored heading, or degraded performance alignment was performed.
 - Present position was not entered during gyrocompass alignment.
 - Present ground speed exceeds 50 knots.
 - INS is in ATTD mode.
- RER 2.5 or greater may appear if destination selected (step 2) does not contain geographic coordinates of aircraft location when terminal update is performed.

If RER less than 2.5 NM appears, proceed to step 7.

6. If RER 2.5 or greater appears, verify selected DEST is correct. If selected DEST is incorrect, use the DEST toggle switch to select correct DEST. If terminal destination has not been programmed into the INU, select the DEST page, enter the DEST coordinates, and reselect INS page. If RER is still 2.5 or greater, write up INS for poor performance.

NOTE

- Selecting a new DEST or altering DEST coordinates will cause a new mission RER to be computed.
7. Record RER on INS DATA CARD.
 8. CDU keyboard pushbuttons — Enter 20.
 9. Miscellaneous address line select key — Depress.

MISC 20 appears in miscellaneous address line on left and X X.X appears on right. (First X is number of mission RER's included in cumulative CEP history, and is less than or equal to 8. First X is followed by two blank spaces, and X.X is cumulative CEP in nautical miles per hour.)

NOTE

- If the mission RER is equal to or greater than 2.5 NM/HR, "SQUAWK" will appear in place of cumulative CEP.
- If mission RER (MISC 19) was RER NA, entry of MISC 20 will not result in a new calculation of CEP. The last calculated CEP will be unaltered.

10. Complete INS DATA CARD.

Prior to engine shutdown:

11. CDU mode selector knob — OFF.

CAUTION

- Wait 30 seconds after turning CDU mode selector knob OFF before turning off or disconnecting power to avoid damaging INS gyros.
- If aircraft power is lost, turn CDU mode selector to OFF. Allow 5 minutes before reselecting CDU mode selector knob to any other position, otherwise damage may result to INS gyros.

12 through 19. Deleted.

Calculations

1. CDU page selector knob — INS.
2. Calculator page access line key — Depress.

NOTE

- Quantities must appear in the X and Y registers in the proper order before performing calculations.

3. The operation of the calculator function is shown in the following examples:

Problem 1: Solve $40 + 125 + (60 - 35)$

a. Key 40 into scratchpad line

Register contents:
 0.00 = T
 0.00 = Z
 0.00 = Y
 (40)

b. Press enter key

Register contents:
 0.00 = T
 0.00 = Z
 40.00 = Y
 ()

c. Key 125 into scratchpad line

Register contents:
 0.00 = T
 0.00 = Z
 40.00 = Y
 (125)

d. Press enter key

Register contents:
 0.00 = T
 40.00 = Z
 125.00 = Y
 ()

e. Key 60 into scratchpad line

Register contents:
 0.00 = T
 40.00 = Z
 125.00 = Y
 (60)

f. Press enter key

Register contents:
 40.00 = T
 125.00 = Z
 60.00 = Y
 ()

g. Key 35 into scratchpad line

Register contents:
 40.00 = T
 125.00 = Z
 60.00 = Y
 (35)

h. Press subtract key

Register contents:
 0.00 = T
 40.00 = Z
 125.00 = Y
 (25.00)

i. Press add key

Register contents:
 0.00 = T
 0.00 = Z
 40.00 = Y
 (150.00)

j. Press add key

Register contents:
 0.00 = T
 0.00 = Z
 0.00 = Y
 (190.00)

Problem 2: Solve $\frac{25 \times 4}{10}$

a. Key 10 into scratchpad line

Register contents:
 0.00 = T
 0.00 = Z
 0.00 = Y
 (10)

b. Press ENTER key

Register contents:
 0.00 = T
 0.00 = Z
 10.00 = Y
 ()

c. Key 25 into scratchpad line

Register contents:
 0.00 = T
 0.00 = Z
 10.00 = Y
 (25)

d. Press ENTER key

Register contents:
 0.00 = T
 10.00 = Z
 25.00 = Y
 ()

e. Key 4 into scratchpad line

Register contents:
 0.00 = T
 10.00 = Z
 25.00 = Y
 (4)

f. Press MULTIPLY key

Register contents:
 0.00 = T
 0.00 = Z
 10.00 = Y
 (100.00)

g. Press X-Y exchange key

Register contents:
 0.00 = T
 0.00 = Z
 100.00 = Y
 (10.00)

h. Press DIVIDE key

Register contents:
 0.00 = T
 0.00 = Z
 0.00 = Y
 (10.00)

IDENTIFICATION SYSTEM — IFF (AN/APX-101)

The identification system enables the aircraft to identify itself when interrogated by proper signals from appropriate radar. Modes 1, 2 and 4 are used for tracking and identification purposes. Modes 3/A and C are used for tracking and altitude reporting, respectively.

Mode 4 operation is provided by the transponder in conjunction with the transponder computer, KIT-1A/TSEC. The KIT-1A/TSEC is classified equipment and must be protected at all times in accordance with applicable security regulations.

The receiver-transmitter contains a BIT module which can monitor transponder responses to operational interrogations, or internally simulate any mode of interrogation by using the test positions of the switches available at the IFF control panel (figure 1-58).

IFF Antenna Switch

The IFF antenna switch (figure 1-57) is a three-position toggle switch, located on the antenna select panel on the left console. The switch is placarded IFF ANT, with positions UPPER, LOWER, and BOTH. UPPER and LOWER positions receive and transmit on the respective antenna. BOTH receives and transmits on the antenna receiving the strongest signal and is the normal position for this switch. The switch must be raised to move out of BOTH.

Mode 4 Caution Light

An IFF caution light (figure 1-65) located on the caution light panel, comes on whenever the IFF caution light circuitry detects an inoperative Mode 4 capability, provided that:

- The KIT-1A/TSEC computer is installed
- The aircraft power is on
- The IFF master switch is not OFF.

ANTENNA SELECT PANEL

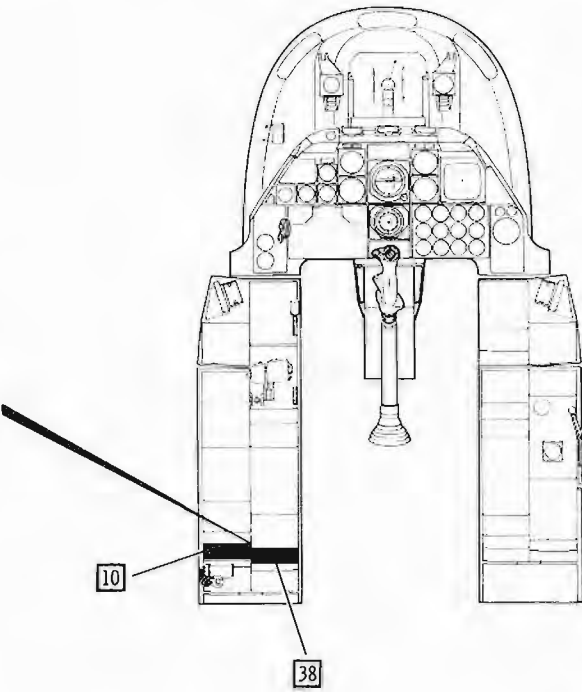
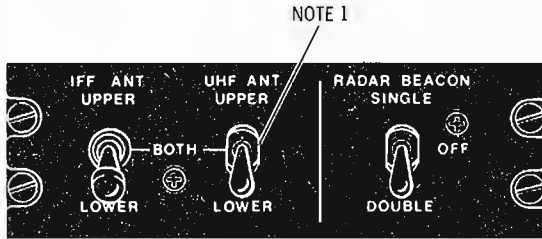

NOTE :

- 1. ON **10**, SWITCH ONLY HAS UPPER AND LOWER POSITIONS.

I-10A-1-59

Figure 1-57

Specific discrepancies monitored by the IFF caution light circuitry are:

- Mode 4 codes zeroed
- Transponder failure to reply to proper interrogation
- Failure of automatic self-test.

NOTE

- If the IFF Mode 4 caution light comes on, the equipment will not respond to Mode 4 interrogations, and the pilot should avoid operation in a known Mode 4 interrogating environment, or if already in one, take appropriate corrective or emergency action.

IFF Operation

The IFF system of the A-10 receives pulse-coded UHF radio signals. The radio signals are captured by antennas and processed. The encoded reply is routed to the antenna which received the strongest signal.

The system includes an “ident” function which is activated by momentarily placing the IDENT/OUT/MIC switch to IDENT, or placing the switch to MIC, which initiates a response each time the UHF radio is keyed. The response will continue for 15 – 30 seconds after initiation.

The emergency mode of operation is initiated by placing the master switch to EMER while in Mode 1, 2 or 3/A. During the ejection sequence a switch automatically enables Modes 1, 2, 3/A, plus emergency. In addition, the Mode 4 code is automatically zeroed.

The Mode 4 function provides a secure IFF capability. Mode 4 is activated by placing the MODE 4 ON/OUT switch to ON, with the master switch in any position except OFF or STBY. The desired code is selected by placing the CODE switch to A or B. The ZERO position of the CODE switch will zeroize the A and B codes if the master switch is at any position except OFF. The A and B codes are set on the ground. Both codes are zeroized when power is removed from the system after the aircraft has landed, unless holding has been executed. Holding is

IFF/SIF CONTROL PANEL

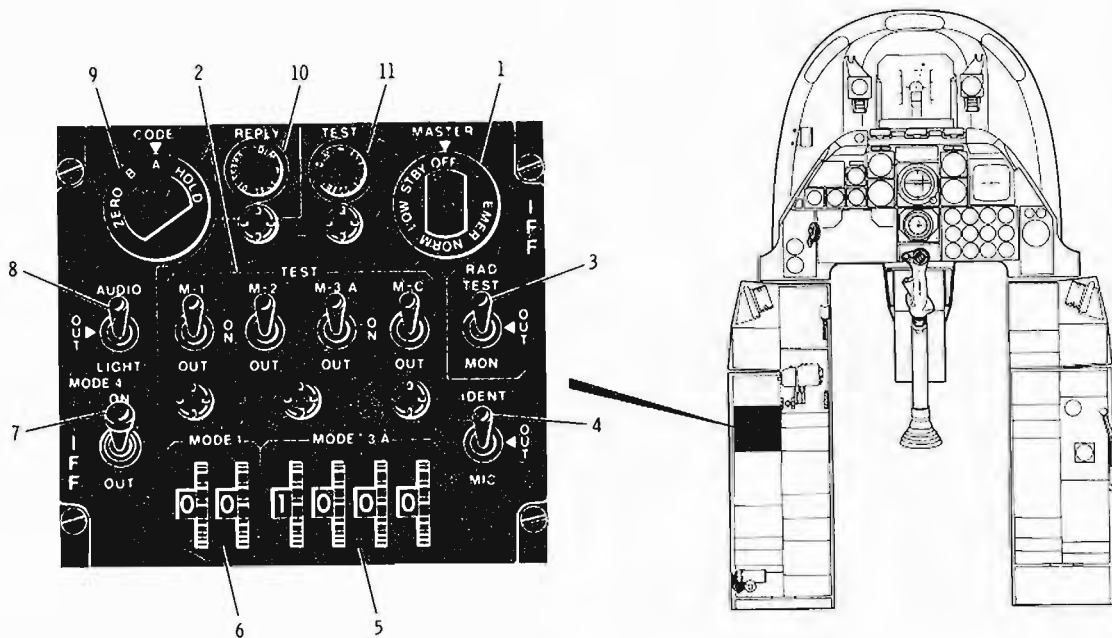

1-10A-1-60

<u>Index No.</u>	<u>Control or Indicator</u>	<u>Position or Display</u>	<u>Function</u>
1	MASTER switch	OFF	IFF system deenergized. The switch must be pulled out to rotate it from STBY to OFF.
		STBY	System in warmup (standby) condition.
		LOW	System operative but at reduced receiver sensitivity.
		NORM	System operative at normal receiver sensitivity.
		EMER	System operative and will respond to interrogations in Modes 1, 2, and 3/A. The reply for Modes 1 and 2 is the code selected on the applicable dials, while Mode 3/A transmits code 7700. The switch must be pulled out to rotate it from NORM to EMER.

Figure 1-58. (Sheet 1 of 4)

<u>Index No.</u>	<u>Control or Indicator</u>	<u>Position or Display</u>	<u>Function</u>	
2	M-1 switch	ON	Selects Mode 1 transponder operation.	
		TEST	Initiates BIT of Mode 1 capability. Go condition indicated by the green TEST lamp coming on.	
		OUT	Disables reply to Mode 1 interrogations.	
	M-2 switch	ON	Selects Mode 2 transponder operation.	
		TEST	Initiates BIT of Mode 2 capability. Go condition indicated by the green TEST lamp coming on.	
		OUT	Disables reply to Mode 2 interrogations.	
	NOTE			
	<ul style="list-style-type: none"> • Mode 2 four-digit reply code is selected on front panel of the receiver/transmitter unit located behind panel F103 (see figure 1-40). 			
	M-3/A switch	ON	Selects Mode 3/A transponder operation.	
TEST		Initiates BIT of Mode 3/A capability. Go condition indicated by the green TEST lamp coming on.		
OUT		Disables reply to Mode 3/A interrogations.		
M-C switch	ON	Enables the transponder set to reply to Mode C interrogations.		
	TEST	Initiates BIT of Mode C circuits in the transponder. Go condition of transponder is indicated by the green TEST lamp coming on.		
	OFF	Disables the reply to Mode C interrogations.		
3	Radiation test monitor switch	RAD TEST	Not used.	
		MON	Permits the BIT circuitry to monitor external interrogation rate versus reply rate of the transponder. Green test lamp will come on if the transponder is being interrogated and replying normally in Modes 1, 2, 3/A, and C.	
		OUT	Disables monitoring capability. Normal position for self-test in Modes 1, 2, 3/A, and C.	

Figure 1-58. (Sheet 2 of 4)

<u>Index No.</u>	<u>Control or Indicator</u>	<u>Position or Display</u>	<u>Function</u>
4	Identification of position switch	IDENT	When momentarily actuated (switch has spring-loaded return) enables identification of position reply for approximately 15 - 30 seconds.
		OUT	Prevents triggering of identification of position reply.
		MIC	Initiates identification of position reply simultaneously with the keying of the UHF radio.
5	MODE 3/A code select switches		Provides coding selection of the Mode 3 reply. Each digit may be set from 0 - 7.
6	MODE 1 code select switches		Provides coding selection of the Mode 1 reply. The digits may be set from 00 - 73.
7	MODE 4 switch	ON	Selects Mode 4 transponder operation.
		OUT	Disables reply to Mode 4 interrogations.
8	Audio light switch	AUDIO	Enables Mode 4 audio operation even when MASTER switch is set to STBY or when Mode 4 switch is set to OUT. Permits audio tone when Mode 4 interrogations are received. Operation of the REPLY light is identical to that described for the LIGHT position. AUDIO is the preferred operating position since an audio tone indicates the presence of Mode 4 interrogations. IFF audio level is adjustable on the INTERCOM panel by rotating the IFF volume control, but the on-off function of this control is nonfunctional.
		LIGHT	When Mode 4 replies are satisfactorily transmitted, the REPLY light will come on. If no replies are being generated to Mode 4 interrogations, the REPLY light will not come on; and, the IFF Mode 4 CAUTION LIGHT/MASTER CAUTION LIGHT will come on. No audio is obtained in this switch position.
		OUT	Disables AUDIO and REPLY light monitoring of Mode 4 interrogations and replies.
9	CODE switch	ZERO	Permits zeroing of Mode 4 code. The switch must be pulled out to rotate it from Code B to zero.
		A/B	Code provided by KIT-1A/TSEC computer.

Figure 1-58. (Sheet 3 of 4)

<u>Index No.</u>	<u>Control or Indicator</u>	<u>Position or Display</u>	<u>Function</u>
9 (Cont)	CODE switch (Cont)	HOLD	Locks in Mode 4 code setting after landing and before power is turned off.
NOTE			
			<ul style="list-style-type: none"> The switch is spring-loaded in HOLD and will return to Code A after release. Code B must be reselected if necessary.
10	REPLY light	On	Indicates presence of Mode 4 replies.
11	TEST light	On	Indicates transponder responding properly to a Mode 1, 2, 3/A, and C test. Light will also come on when depressed.

Figure 1-58. (Sheet 4 of 4)

accomplished by momentarily placing the CODE switch to HOLD after landing, but prior to removal of power from the system. System power should be maintained for at least 15 seconds after the CODE switch is placed in HOLD. The receiver-transmitter will respond to Mode 4 interrogations only if the interrogations are coded the same as the code selected on the CODE switch. Placing the audio light switch to AUDIO enables an audio signal in the pilot's headset when valid Mode 4 interrogations are being received, and the Mode 4 REPLY light (green) coming on indicates when replies are transmitted. In the LIGHT position, the Mode 4 REPLY light will come on when Mode 4 replies are transmitted. The level of the Mode 4 audio is adjustable on the INTERCOM control panel by rotating the IFF volume control. In the OUT position on the IFF control panel, both light and audio indications are inoperative. The REPLY light will not press-to-test when the switch is in OUT.

If the Mode 4 caution light comes on, the pilot should place the IFF MASTER control switch to NORM, check the Mode 4 ON-OUT toggle switch is ON, and proper code, A or B, has been selected for the current code time period. If the IFF Mode 4 caution light stays on, the pilot should then employ the applicable flight procedures which are operationally directed for inoperative Mode 4 or avoid the Mode 4 environment.

In addition to the operational modes, the system has a BIT capability for confidence testing on a go/no-go basis. The BIT can monitor transponder responses to operational interrogations, or internally stimulate any mode of interrogation by placing the M-1, M-2, M-3/A or M-C switch on the control panel to TEST. A correct reply to the interrogation will cause the TEST light to come on on the control panel indicating a go condition. If a no-go response is made with the IFF ANT switch in BOTH, the test shall be repeated in UPPER and LOWER. A go response in either UPPER or LOWER indicates an operational IFF system on that antenna.

X-BAND RADAR BEACON SYSTEM

The AN/UPN-25 X-band beacon system, if installed, consists of an encoder-transponder, control switch, and antenna. The AN/UPN-25 provides the aircraft with an increased radar cross section. Power from the left DC system bus is applied when the control switch is moved from OFF.

The encoder-transponder may be operated in single pulse or double pulse mode. One of nine double pulse codes is preselected by ground crew, but the option of a single or double pulse reply is made by the pilot through the radar beacon control switch.

Radar Beacon Control Switch

The radar beacon control switch (figure 1-57), placarded RADAR BEACON, is located on the antenna select panel. It is a three-position toggle switch. The switch positions are SINGLE, DOUBLE, and OFF. In SINGLE, the transponder will transmit one reply pulse for each interrogating pulse received. In DOUBLE, the transponder will transmit one of nine preselected double-spaced codes for each interrogating pulse received. The system is powered by the left DC bus.

INTERCOM SYSTEM

The intercommunications system provides the audio interface between the pilot and the onboard communication and radio navigation equipment. The intercom system also interfaces with the inflight refueling system to provide for direct communications with the tanker aircraft. The system consists of an intercommunication set control located on the left console, and the pilot's headset/microphone assembly. An external interphone station enables communication with the ground crew.

The intercommunications set control (figure 1-59), includes both headset and microphone amplifiers. Each audio input has a separate switch and volume control. A master volume control adjusts the volume level of all audio inputs simultaneously. The landing gear warning signal bypasses the electronics of the control set and is coupled directly to the pilot's headset.

In addition to the audio monitoring capability, a rotary selector switch on the intercommunications control panel permits the pilot to select the interphone or transmitter keying circuits for up to four receiver/transmitters.

Electrical power is supplied by the DC essential bus.

MIC Switch

A three-position sliding MIC switch is located on the right throttle. The functions of the positions are as follows:

- Center position — Receive.
- UP position — Enables radio as selected by the rotary selector switch on the intercom control panel.
- DOWN position — Enables the UHF radio.

UHF RADIO SYSTEM

The UHF radio system consists of a panel-mounted UHF radio [AN/ARC-164(V) Radio Set], and an associated antenna system. The UHF radio (figure 1-60) is located in the left console.

Some UHF radios (HQ UHF) have a jam-resistant frequency hopping capability when operating in the active mode.

The UHF radio is capable of maintaining two-way line-of-sight communications over a normal operational range of 220 nm depending on the frequency and aircraft altitude. Communications may be conducted in one of 20 preset channels, or in any one of 7,000 manually selected frequencies spaced 25 KHz apart throughout the 225.0 – 399.975 MHz frequency range.

In addition, the UHF radio is capable of simultaneously monitoring the UHF guard channel (243.0 MHz) through a separate receiver. The pilot can monitor both guard and working channels, or monitor the working channel only. For transmitting purposes, guard channel may be selected by placing the MANUAL-PRESET-GUARD switch on the control panel to GUARD. This automatically shifts the main receiver and transmitter to the guard channel. The UHF radio is powered by the DC essential bus.

The UHF radio is fully compatible with secure communications equipment KY-28 or KY-58 (when installed).

UHF Automatic Direction Finding

The ADF capability is activated by placing the UHF radio function selector in ADF. The ADF provides relative bearing to any steady signal received on the UHF main receiver. This information is displayed on the HSI number 2 bearing pointer on 61 and on the HSI number 1 bearing pointer for all other aircraft. The guard receiver is disabled when ADF is selected. For HQ UHF radios, in the active mode, ADF will function, but accuracy will be degraded. Voice reception may be degraded in ADF. Selecting ADF also causes the navigation mode select panel UHF homing light to come on. The UHF/ADF is powered by the right DC bus.

UHF Radio Antenna System

The UHF radio system has two antennas, upper and lower, shared with the TACAN navigation system. The antenna system provides automatic or manual selection of either antenna.

INTERCOM CONTROL PANEL

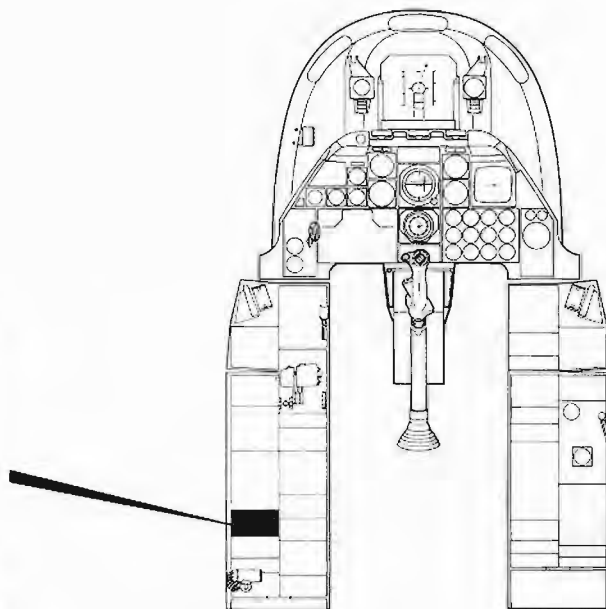
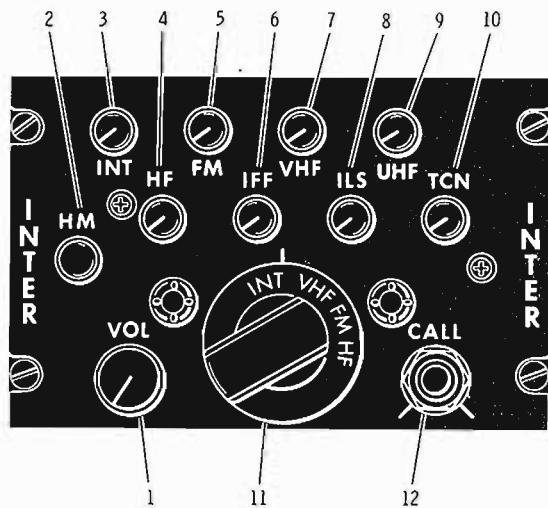

1-10A-1-61

<u>Index No.</u>	<u>Control</u>	<u>Function</u>
1	VOL control	Adjusts volume level of all audio inputs simultaneously.
2	HM switch	<p>Switch in the pulled-out position enables hot mic interphone operation, allowing communication with the tanker during air refueling or with ground crew without using the mic button. Rotary selector switch (11) must be set to INT, or INT monitor switch (3) must be in the pulled-out (enable) position for hot mic operation.</p> <p>HM switch in the pushed-in position disables hot mic operation.</p>
3	INT monitor switch	<p>Switch in pulled-out position enables interphone operation allowing communication with the tanker during air refueling, or with the ground crew when HM switch is also in the pulled-out position; or interphone audio to be monitored from the tanker during air refueling or from the ground crew regardless of the position of the intercom rotary selector switch (11). An integral volume control permits individual control of the interphone audio level.</p>

Figure 1-59. (Sheet 1 of 3)

<u>Index No.</u>	<u>Control</u>	<u>Function</u>
		Switch in the pushed-in position disables the interphone audio from being monitored unless it is selected via the intercom rotary selector switch.
4	HF monitor switch 103	An audio tone is provided to the headset through the INTERCOM CONTROL PANEL when the AIM-9 MODE SWITCH is in the SELECT position. To receive missile audio, the HF switch on the INTERCOM CONTROL PANEL must be pulled out to its active position. The audio level is controlled by rotating the switch to the desired level.
5	FM monitor switch	Switch in pulled-out position enables VHF/FM receiver audio to be monitored regardless of the positions of the intercom rotary selector switch. An integral volume control permits individual control of the VHF/FM receiver audio level. Switch in the pushed-in position disables the VHF/FM receiver audio from being monitored unless it is selected via the intercom rotary selector switch.
6	IFF monitor switch	Nonfunctional as an on-off control. Volume control permits individual control of the IFF receiver audio level.
7	VHF monitor switch	Same as item 5 except controls VHF/AM receiver audio.
8	ILS monitor switch 47	Switch in the pulled-out position enables localizer and marker beacon identifier audio to be monitored in the headset. Switch in the pushed-in position disables localizer and marker beacon identifier audio.
9	UHF monitor switch	Same as item 5 except controls UHF receiver audio.
10	TCN monitor switch	Switch in pulled-out position enables TACAN receiver audio to be monitored regardless of the position of the intercom rotary selector switch. An integral volume control permits individual control of the TACAN receiver audio level. Switch in the pushed-in position disables the TACAN receiver audio from being monitored unless the intercom rotary selector switch is rotated to the extreme CCW position.
11	Rotary selector switch	Provides for the selection of interphone and radio transmitter microphone and keying circuits, and automatically enables the selected audio.

Figure 1-59. (Sheet 2 of 3)

<u>Index No.</u>	<u>Control</u>	<u>Function</u>
11 (Cont)	INT	Provides intercommunications with ground crew. If HM is disabled, the mic button on the throttle must be pressed for the pilot to talk to the ground crew. If the INT monitor switch is in the enable position, the ground crew may call the pilot regardless of the position of the rotary selector switch. For the pilot to answer, the selector switch must be in INT or the HM switch must be in the enable position.
	VHF	Provides microphone input to the VHF/AM transmitter, and permits keying of the transmitter when the press-to-talk switch on the throttle is pressed.
	FM	Same as VHF except controls VHF/FM radio.
	HF	Not used.
	Unplacarded (full CCW position)	Enables the TACAN receiver audio to be monitored regardless of TCN monitor switch position.
12	CALL switch	Not used.

Figure 1-59. (Sheet 3 of 3)

UHF Antenna Select Switch

The antenna select switch (figure 1-57), placarded UHF ANT, is a three-position toggle switch, located in the center of the antenna select panel on the left console. The antenna select switch enables the pilot to select either the UPPER or LOWER antenna for optimum radio performance. If BOTH is selected, the system will cycle between both antennas and select the first one receiving a signal above a preselected level. In the event of power loss to the antenna circuit, a switching circuit automatically selects the lower antenna. On [10], the antenna select switch is a two-position switch, with positions placarded UPPER and LOWER. The BOTH position has been deleted. On [54], select LOWER when ADF is selected on the UHF radio panel. The antenna select switch is powered by the DC essential bus through the UHF COMM circuit breaker.

UHF Radio Operation (Normal Mode)

Frequency selection can be accomplished in one of three modes: PRESET, MANUAL, and GUARD.

OPERATION IN PRESET MODE

1. Set function selector to MAIN or BOTH.
2. Place MANUAL-PRESET-GUARD switch to PRESET.
3. Set desired channel with preset channel selector knob.

OPERATION IN MANUAL MODE

1. Set function selector to MAIN or BOTH.
2. Place MANUAL-PRESET-GUARD switch to MANUAL.
3. Set desired frequency by manually tuning the frequency selector switches.

UHF RADIO CONTROLS

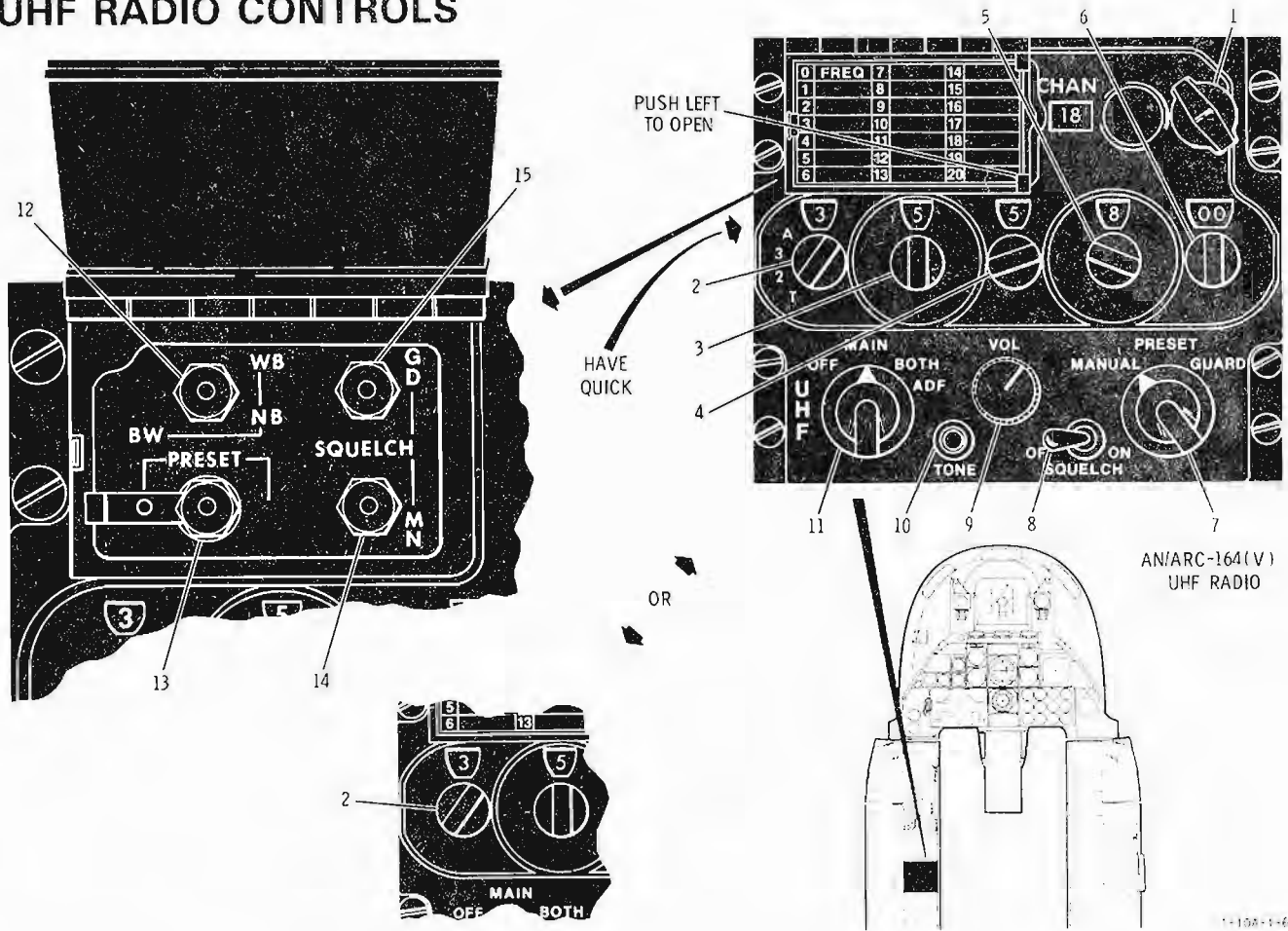

<u>Index No.</u>	<u>Switch/Control</u>	<u>Function</u>
1	Preset channel selector	Selects preset channel frequencies or a net number stored in the nonvolatile memory.
	Manual frequency selectors	
2	100 MHz selector switch (A-3-2-T switch on HQ UHF)	Selects 100s digit of desired frequency (either a 2 or 3) in the normal mode. The A position selects the active mode and displays an A preceding the net number. The T is a momentary, spring-loaded position. The T position enables the radio to receive a new TOD. The A and T positions override the 100s digit in both MANUAL and PRESET frequency mode of operation.
3	10 MHz selector switch	Selects 10s digit of frequency (0 - 9). Selects first digit of net number in active manual mode.
4	1 MHz selector switch	Selects units digit of frequency (0 - 9). Selects second digit of net number in active manual mode.

Figure 1-60. (Sheet 1 of 2)

<u>Index No.</u>	<u>Switch/Control</u>	<u>Function</u>
5	0.1 MHz selector switch	Selects 10s digit of frequency (0 - 9). Selects third digit of net number in active manual mode.
6	0.025 MHz selector switch	Selects 100s and 1000s digits of frequency (00, 25, 50, or 75).
7	MANUAL-PRESET-GUARD	Selects mode of frequency selection.
	MANUAL	Frequency is manually selected using the five frequency selector switches.
	PRESET	Frequency is selected using the preset channel selector switch; also used when programming preset channels.
	GUARD	The main receiver and transmitter are automatically tuned to 243.000 MHz guard frequency and the guard receiver is disabled.
8	SQUELCH ON-OFF	Enables and disables squelch of main receiver.
9	VOL	Adjusts audio level.
10	TONE	Transmits TOD 1667 Hz signal when pressed if the radio TOD clock has been started. If the radio TOD clock has not been started, and on non-HQ UHF radios, only a 1020 Hz tone will be transmitted. The 1020 Hz tone also follows a TOD transmission.
11	Function selector	Selects operating mode.
	OFF	Shuts down equipment.
	MAIN	Enables main receiver and transmitter.
	BOTH	Enables main receiver and transmitter and guard receiver.
	ADF	Enables ADF or homing system (if installed) and main receiver/transmitter. Disables guard receiver and TONE transmit function.
12	Bandwidth (BW) (NB-WB)	Maintenance adjustment.
13	PRESET	Stores selected data in specified preset channel non-volatile memory.
14	SQUELCH-MN (main squelch)	Maintenance adjustment.
15	SQUELCH-GD (guard squelch)	Maintenance adjustment.

Figure 1-60. (Sheet 2 of 2)

OPERATION IN GUARD MODE

1. Set function selector to MAIN or BOTH.
2. Place MANUAL-PRESET-GUARD switch to GUARD.

NOTE

- When operating in the GUARD mode, the main receiver and transmitter are tuned to the guard frequency automatically. The guard receiver is disabled.

ENTERING PRESET FREQUENCIES

1. Place MANUAL-PRESET-GUARD switch to PRESET.
2. Set manual frequency using manual frequency selectors.
3. Set preset channel selector to desired channel.
4. Depress PRESET button.

HAVE QUICK I UHF SYSTEM (JAM-RESISTANT)

The HQ UHF system provides normal and jam-resistant UHF communications. The usual operating mode for the HQ UHF radio is normal mode where the radio uses 1 of 7,000 frequencies. The jam-resistant (active) mode enables a frequency hopping scheme. Because the particular frequency used at any instant depends on the precise TOD, participating HQ UHF radios must be synchronized. In addition, the HQ UHF radio must have a WOD and net number to achieve jam-resistant communications.

Word-of-Day Entry

WOD is entered by using one or more of the six preset channels 15 - 20. For a new WOD entry, use the same method as in entering preset frequencies in the normal mode. Once WOD is entered, it remains stored in the applicable preset channels in the same manner as preset frequencies are stored. However, the radio will not operate in the active mode until the WOD is transferred to volatile memory.

WOD Transfer to Volatile Memory

To transfer WOD, select PRESET, channel 20, and listen for a single or double beep. A single beep indicates that channel 20 WOD data has been transferred. Select remaining preset channels (19 - 15) in the same manner and listen for a single or double beep at each channel. When a double beep is heard, WOD transfer is complete. WOD transfer must be accomplished any time power to the radio has been interrupted, the radio has been turned off, or if channel 20 is selected.

Time-of-Day Reception

TOD reception is possible in both normal and active modes. The radio automatically accepts only the first TOD message received after the radio is turned on. Subsequent messages are ignored unless the T position is momentarily selected with the A-3-2-T knob. The radio then accepts the next TOD update in either normal or active mode, provided TOD arrives within 1 minute of the time the T position has been selected. To receive time in the normal mode, rotate the A-3-2-T knob to T position and return to a normal frequency in either manual or preset mode. To receive a time update in active mode, rotate the A-3-2-T knob to the T position and then back to the A position. A TOD update (time tick) can now be received on the selected active net.

Time-of-Day Transmission

A synchronized radio (TOD entered) can transmit timing information in both normal and active modes, by momentarily pressing the TONE button. In the normal mode, a complete TOD message is transmitted, while in the active mode only an updating time tick is used. Active mode time transmission allows a time update if a participant has drifted out of synchronization.

Net Number

After TOD and WOD have been entered, and WOD has been transferred to volatile memory, any valid active net number can be selected by using the manual frequency knobs or preset channel selector (1 - 14).

Conference Capability

In the active mode, the radio has the ability to receive and process two simultaneous transmissions on the same net. The receiver will read both transmissions without the interference normally associated with two radios transmitting on the same frequency simultaneously. Three simultaneous transmissions will result in garbled reception. Conferencing is disabled when the net number is followed by 25.

Guard Operation

The guard receiver is not affected by operations in the active mode. Guard frequency may be monitored regardless of what mode the radio is in as long as the function selector is in BOTH. Selecting guard on the MANUAL-PRESET-GUARD switch disables the active mode and puts the main receiver/transmitter on frequency 243.000 MHz.

Jam-Resistant (Active) Mode Operation

To operate the HQ UHF radio in the active mode, proceed as follows:

1. Set function selector to MAIN or BOTH.
2. Place MANUAL-PRESET-GUARD switch to PRESET.
3. Enter WOD (if necessary) in preset channels 15 - 20 and then, starting with channel 20, rotate the preset channel knob CCW until a double beep is heard.
4. Enter TOD by selecting the frequency on which the TOD is being transmitted, or by requesting a TOD transmission from a synchronized radio.
5. Set A-3-2-T knob to A.
6. Select an active net number either with the manual frequency knobs or any preset channel (1 -14) designated for active net use.

TOD and WOD may be entered in any order once the radio is turned on. A tone is heard in the headset if TOD has not been initially received, or if WOD has not been transferred/entered.

UHF Remote Frequency/Channel Indicator

The indicator displays the frequency, channel, net, or WOD being utilized by the main receiver/transmitter (22, figure FO-1).

<u>MODE</u>	<u>DISPLAY</u>
Normal manual	Six digit frequency
Normal preset	Two digit channel number
Guard	G

MODE

DISPLAY

Active manual	"3" plus three digit net number, plus last two digits
Active preset	Six digit nonvolatile preset memory
T manual	"3" plus five remaining frequency numbers
T preset	Six digit nonvolatile preset memory

UHF COMMAND RADIO (AN/ARC-164) [109]

HAVE QUICK II (HQ II) SYSTEM OPERATION

There are four separate COMMAND CODE functions associated with the activation of a HQ II radio. These command codes are used to access memory locations and process instructions without unnecessarily consuming preset storage or necessitate switch modifications. The operator enters a six digit command code into PRESET channel 20 to begin the unique initialization procedure. Thereafter, all other switch actions are performed with the radio in the MANUAL mode, but using switch actions normally associated with loading preset channels.

HQ II COMMAND CODES	
COMMAND CODE	FUNCTION
220,000	VERIFY/OPERATE
220.025	MWOD LOAD
220.050	MWOD ERASE
220.075	FMT-NET FREQUENCY LOAD

FREQUENCY MANAGED A-NETS (FMA-Nets)

The geographical area of operation will determine which net number is to be selected from the available frequency tables or hopsets. These active nets are identified as FMA-Nets. One large hopset has been coordinated for use in NATO-Europe and another large hopset for employment in non-NATO countries. The frequency table to be employed is determined by the last two digits of the net numbers A00.0XX to A99.9XX. Active nets are selected in accordance with ABB.BCC where:

1. A = A (Active)
2. BB.B = Desired net
3. CC = 00 for Basic HAVE QUICK
25 for NATO-Europe
50 for Non-NATO
75 Non-operational

HQ II FREQUENCY MANAGED TRAINING (FMT) NETS

To expand the number of training nets available to HQ users, HQ II provides 16 FMT-nets including the 5 T-nets already in the HQ system. To use the FMT-nets, 16 training frequencies must be loaded into the radio. Ideally, a 4 MHz frequency separation is maintained to reduce interference between collocated radios. Unlike basic HQ, these frequencies are not part of the training Word-of-Day. The procedure for loading FMT-net frequencies need only be repeated if the authorized training frequencies change. Sixteen frequencies that maintain 4 MHz minimum separation have been approved for CONUS training.

To use FMT-Nets, a basic training Word-of-Day must first be entered. The frequencies loaded into presets 19 through 15 during training Word-of-Day entry will have no effect on the FMT-nets but will determine the frequencies used when a basic HQ T-net is selected. The 6 digit training WOD loaded into preset 20, as with basic HQ, cause the radio, when active, to operate in the training mode. The hop rate (same as basic HQ) is determined by the last two digits loaded into preset 20.

The 16 FMT-nets are selected the same as other active nets. They are numbered A00.025 through A01.525 and they do not repeat. All six characters in the net designator must be selected and the last two digits must be 25. Selection of an FMT-net greater than A01.525 or ending in 50 or 75 will result in an audio alarm (interrupted tone).

BASIC T-NETS

Basic T-nets are selected the same as in basic HQ except that all six digits are now read and the last two must have 00. The T-nets are numbered A00.000 through A00.400 and they do not repeat. All six characters in the net designator must be selected. Selection of a T-net greater than A00.400 or ending in 50 or 75 will result in an audio alarm (uninterrupted tone). Selection of a T-net ending in 25 will result in HQ II FMT-net operation. The conversion of the Basic T-Net to a HQ II net is indicated in Figure 2 below.

T-NET CONVERSION	
BASIC T-NET	HQ II T-NET
A00.0 (same net as A00.5)	A00.000
A00.1	A00.100
A00.2	A00.200
A00.3	A00.300
A00.4	A00.400
A00.5	A00.500

The following are step-by-step instructions on enabling HQ II features.

VERIFY/OPERATE

To conserve radio presets, the MWOD Load, MWOD Erase and FMT-Net frequency load switch actions are performed using switch actions very similar to those used to load channel presets, but with the radio in the MANUAL mode. The VERIFY/OPERATE command alerts the radio that the above MWOD/FMT-Net functions have been completed and restores the radio to the normal operating condition where channels are related to PRESET switch actions. This mode is also used to verify that current MWODs are loaded. The radio will not transmit (not even normal UHF) until radio is returned to the VERIFY/OPERATE mode.

VERIFY/OPERATE command is entered as follows:

1. Set channel selector switch to 20.
2. Set function selector switch to PRESET.
3. Set frequency selector switches to 220.000 (VERIFY/OPERATE).
4. Press and release PRESET load button. (Listen for single beep).

NOTE

- High pitched continuous tone indicates WOD or TOD not loaded. An Interrupted tone indicates invalid net selected.
- An HQ II radio must be in the VERIFY/OPERATE mode to transmit. Enter the VERIFY/OPERATE command (220.000) after all MWOD Loads/Erases and FMT-Net Frequency Loads. The radio will power up in the same mode it was in when powered down. If the radio does not function as expected at power up, enter the VERIFY/OPERATE command.

MULTIPLE WORK-OF-DAY LOADING.

1. Set channel selector switch to 20.
2. Set function selector switch to PRESET.
3. Set frequency selector switches to 220.025 (MWOD Load).
4. Press and release PRESET load button. (Listen for single beep).
5. Set function selector switch to MANUAL.
6. Set frequency selector switches to element 20 of the WOD.

7. Press and release TONE button (Listen for single beep).
8. Set channel selector switch to 19.
9. Set frequency selector switches to element 19 of the WOD.
10. Press and release TONE button (Listen for single beep).
11. Repeat steps 8 through 10, decreasing the channel and WOD element numbers by one for each WOD element through 15.
12. Set channel selector switch to 14.
13. Set frequency selector switches to element 14 (Day-of-Month Tag) of the WOD.

NOTE

- Multiple WODs must be linked with an associated day-of-month. This "date tag" element has been added to every operational and training segment in basic HQ and need only be loaded when MWOD is used.
14. Press and release TONE button (Listen for double beep).
 15. To load additional MWODs, set channel selector switches to 20 and repeat steps 6 through 14 above. The six most recently entered MWODs will be stored in the radio.
 16. Set channel selector switch to 01.
 17. Set frequency selector switches to current day-of-month. The format is 3AB.000, where A is the 10's digit and B is the 1's digit of the current day-of-month. For example, if today were 26 June, then select 326.000.
 18. Press and release TONE button (Listen for single beep).
 19. Set function switch to PRESET.
 20. Set channel selector switch to 20.
 21. Set frequency selector switches to 220.000 (VERIFY/OPERATE).
 22. Press and release PRESET load button (Listen for single beep). The radio is now ready to receive Time-of-Day and then operate in the active mode.

NOTE

- HQ II radios are designed to transmit and receive date information in the Time-of-Day signal (MICKEY). A future modification to the Reference

Signal Generator (RSG) will result in date information being transmitted in all MICKEYS. This will alleviate the need to perform steps 16 through 18 above. In the meantime, HQ II radios can append date information to their MICKEY if they are manually loaded with Day-of-Month (steps 16 through 18 above), are self-started, and then receive a basic MICKEY. This expanded MICKEY may then be passed to other HQ II radios using MWODs. The appended date information is transparent (not usable) to basic HQ radios.

- When using MWOD procedures (radio in VERIFY/OPERATE mode), the operator must load the current date into the radio prior to receiving TOD or receive a TOD with a date appended. Without date information, the radio cannot select the current Word-of-Day from memory. This results in an alarm (steady tone) when the active mode is selected.

VERIFYING AN MWOD IS LOADED.

With the radio in the VERIFY/OPERATE mode (220.000 entered into preset channel 20) the operator may verify the storage of a particular days WOD as follows:

1. Set function switch to MANUAL.
2. Set channel selector switch to 20.
3. Set frequency selector switches to Day-of-Month to be verified. The format is 3AB.000, where A is the 10's digit and B is the 1's digit of the Day-of-Month (5 May would be 305.000).
4. Set channel selector momentarily to 19 and return to 20. A single beep indicates WOD for that day is loaded. No beep indicates WOD for that day is not loaded. Repeat for each day to be verified.

MWOD OPERATION.

Once the operator has been assured or has verified the loading of current MWOD (steps 1 through 4 above) the radio must be provided the current Day-of-Month so that radio can transfer the correct MWOD segment from memory into the radio's processor. There are two ways to enter Day-of-Month information into a HQ II radio, by receiving a MICKEY from a HQ II radio loaded with current Day-of-Month or by entering it manually.

Receiving a HQ II MICKEY is the preferred method of initializing a radio loaded with MWODs. A HQ II MICKEY consists of date information

(day-of-month and year) appended to Time-of-Day and will originate from an AN/TRC-187 HQ II Time Signal Set which will append manually supplied date information to Time-of-Day supplied by the TRANSIT satellite system. Date information will be supplied to the Time Signal Set once and need only be reinitialized following a power interruption. Upon receipt of a HQ II MICKEY, a HQ II radio will set its clock to the correct Time-of-Day and Day-of-Month (derived from the date information) and transfer the correct MWOD segment into its processor. With these actions completed, the radio is ready for active net selection. If a mission should run into the next zulu day, the radios clock will update to the next day and, if it has been loaded, the correct WOD will be transferred into the radios processor. If the next days WOD has not been loaded, the current days WOD will be repeated.

NOTE

- Because HQ II radios do not experience midnight madness, they cannot communicate with a basic HQ radio that has passed through 2400Z until the basic HQ radio is reinitialized.

If a HQ II MICKEY (date information appended to Time-of-Day) is not available, the operator will have to manually enter the current Day-of-Month. With a manually loaded Day-of-Month, the radio is ready for active net selection as if date information were received from a HQ II MICKEY. A HQ II radio can append date information to its MICKEY, but this requires the operator to manually enter Day-of-Month and then self-start the radios clock. When this procedure is completed, the radio appends the Day-of-Month into the Day-of-Year slot of the MICKEY and sets the year of the MICKEY to 80. Since the clock has been self-started (arbitrary time), the radio should further receive a true MICKEY (zulu time) in order to correctly align its Time-of-Day. Because manual entry of Day-of-Month requires many switch actions, consider using this procedure to load a master TOD source (a HQ II equipped RSG) and then using the procedure described previously to initialize all other radios. Once loaded, the master radio need only be reinitialized following a power interruption or at the beginning of the next month. The steps for manual entry of Day-of-Month are as follows:

1. Set function switch to PRESET.
2. Set channel selector switch to 20.
3. Set frequency selector switches to 220.025 (MWOD LOAD).

4. Press and release PRESET load button (Listen for single beep).

5. Set function switch to MANUAL.

6. Set channel selector switch to 01.

7. Set frequency selector switches to current Day-of-Month. The format is 3AB.000, where A is the 10's digit and B is the 1's digit of the current Day-of-Month. For example, 23 July would be 323.000.

8. Press and release TONE button (Listen for single beep).

9. Set function switch to PRESET.

10. Set channel selector switch to 20.

11. Set frequency selector switches to 220.000 (VERIFY/OPERATE).

12. Press and release PRESET load button (Listen for single beep).

13. Set channel selector switch to MANUAL.

14. Self-start the radios clock.

15. At this point the radio is ready to receive a normal MICKEY (request MICKEY, momentarily select T, tune to MICKEY frequency and wait for TOD signal). When the radio receives the MICKEY, it will load the MWOD segment matching the Day-of-Month entered into the radio. The radio is also now capable of passing HQ II MICK-EYs to other radios.

MWOD ERASE. The MWOD memory can be erased as follows:

1. Set function switch to PRESET.

2. Set channel selector switch to 20.

3. Set frequency selector switches to 220.050 (MWOD Erase).

4. Press and release PRESET load button (Listen for single beep).

5. Set function selector to MANUAL.

6. Press and release TONE button (Listen for single beep).

7. At this point all MWODs have been erased and transmit is disabled. To enable transmit or, in non-emergency situations, to return the radio to its normal configuration continue as follows:

a. Set function switch to PRESET (Channel 20 is still selected).

b. Set frequency selector switches to 220.000 (VERIFY/OPERATE).

c. Press and release PRESET load button (Listen for single beep). The radio will now transmit in normal UHF.

FMT-NET FREQUENCY LOADING.

The following are general instructions for loading FMT-NET frequencies.

1. Set function switch to PRESET.
2. Set channel selector switch to 20.
3. Set frequency selector switches to 220.075 (FMT-Net Freq. Load).
4. Press and release PRESET load button (Listen for single beep).
5. Set function switch to MANUAL.
6. Set frequency selector switches to training frequency #1.
7. Press and release TONE button (Listen for single beep).
8. Set channel selector switch to 19.
9. Set frequency selector switches to training frequency #2.
10. Press and release TONE button (Listen for single beep).
11. Repeat steps 8 through 10, decreasing the channel number by one for each training frequency until all 16 frequencies are loaded.
12. Set function switch to PRESET.
13. Set frequency selector switches to 220.050 (VERIFY/OPERATE).
14. Press and release PRESET load button (Listen for single beep). The FMT-net frequencies are now loaded and need not be reloaded until the approved training frequencies change.

NOTE

- When selecting FMT-Net frequencies, a 4 MHz minimum frequency separation should be maintained. Additionally, the radio will accept the frequencies in any order, but they must be loaded in the same order in all radios to maintain interoperability.

With an understanding of the previous section, the following can be used as a checklist for loading CONUS FMT-net training frequencies. The frequencies are in the order suggested for use throughout the CONUS.

1. Select PRESET and CHANNEL 20.
2. Select 220.075.

3. Press and release PRESET load button.
4. Select MANUAL.
5. Load (using the TONE button) 235.050 into channel 20.
6. Load 225.150 into channel 19.
7. Load 252.925 into channel 18.
8. Load 239.950 into channel 17.
9. Load 271.950 into channel 16.
10. Load 267.850 into channel 15.
11. Load 262.450 into channel 14.
12. Load 257.250 into channel 13.
13. Load 314.450 into channel 12.
14. Load 308.750 into channel 11.
15. Load 303.275 into channel 10.
16. Load 298.650 into channel 09.
17. Load 293.550 into channel 08.
18. Load 289.050 into channel 07.
19. Load 284.150 into channel 06.
20. Load 279.750 into channel 05.
21. Select PRESET and CHANNEL 20.
22. Select 220.000 (VERIFY/OPERATE).
23. Press and release PRESET load button.

To verify that a radio is EMB modified, the following operational checks may be performed. The first procedure is preferred because the second procedure removes any WOD element stored in preset channel 20.

1. If the radio is already successfully operating in the active mode, select any active net ending in 75 (i.e., A52.275). If a fault tone (interrupted tone) is heard, the radio is EMB modified. Nets ending in 75 have been reserved for a future faster hopping modification (HQ IIA) and are not used with HQ II.
2. If the radio is powered but has not been initialized for active operation the following procedure may be used to verify that a radio is EMB modified:
 - a. Set function selector switch to PRESET.
 - b. Set channel selector switch to 20.
 - c. Set frequency selector switches to 220.000 (VERIFY/OPERATE).
 - d. Press and release the PRESET load button. A single beep may be heard (indicating the

EMB radio was not in the VERIFY/OPERATE mode or the non-EMB radio has accepted 220.000 as a WOD element) or there may be no beep (indicating the radio is EMB modified and was already in the VERIFY/OPERATE mode).

e. If a beep was heard at step d, set the channel selector switch to 19. If there is no beep, the radio is EMB modified. A basic HQ radio will beep once (if the first digit of the number stored in preset 19 is a 2) or twice (if the first digit of the number stored in preset 19 is a 3).

OPERATING HQ II RADIOS IN THE BASIC HQ MODE.

When a basic HQ net (except T-Net) is selected on a HQ II radio, the Word-of-Day will determine which algorithm is used. Because basic HQ radios are not programmed with the improved algorithm, operational and training Word-of-Day material is designed to select the original algorithm in HQ II radios to maintain interoperability with basic HQ radios.

NOTE

- When using a HQ II radio to communicate on basic HQ nets, the hundredths/thousandths frequency selector switch must be set to double zero. The conferencing option previously controlled by this switch is determined by the Word-of-Day element loaded into preset 19.

B. With the information provided the following checklist should be sufficient to guide an operator through the necessary switch actions to operate a HQ II radio.

ABBREVIATED HQ II CHECKLIST

RECEIVE TOD (Same switch actions as basic HQ).

1. Select TOD frequency - Request TOD.
2. A-3-2-T Switch - Momentarily to T and return to TOD frequency.
3. Listen for one or two step tone within 60 seconds.

SEND TOD (Same switch actions as basic HQ)

1. Radio contact - ESTABLISH.
2. Tone button - PRESS.

VERIFICATION OF MWOD LOADING (COMBAT MODE)

1. VERIFY/OPERATE (Radio in COMBAT MODE).
 - a. Mode Selector - PRESET.

- b. Channel select - 20.
- c. Frequency select - 220.000.
- d. PRESET button - PRESS.

2. CHECK DAY.

- a. Mode Selector - MANUAL.
- b. Frequency select - 3XX.000 (Where XX=day to verify).
- c. Channel Selector - Momentarily to 19 then return to 20 (A beep upon returning to channel 20 indicates an MWOD is loaded for date checked).

TRAINING MODE OPERATIONS

Radio Set-up: FMT-Net or training WOD frequencies not previously entered.

1. Activate FMT-Net frequency load or change.
 - a. Mode Selector - PRESET.
 - b. Channel select - 20.
 - c. Frequency select - 220.075.
 - d. PRESET button - PRESS (Hear beep).
2. LOAD FMT-Net Frequencies (channels 20 - 5)
 - a. Mode Select - MANUAL.
 - b. Channel select - PRESET to be loaded (20,19. . .)
 - c. Frequency select - Set frequency for selected PRESET.
 - d. TONE button - PRESS (Hear beep).
 - e. Repeat b through d as necessary.
3. Load basic HQ training WOD (Channels 20 - 15)
 - a. Mode Select - PRESET.
 - b. Channel selector - PRESET to be loaded (20, 19. . .)
 - c. Frequency select - Set WOD segment for PRESET selected.
 - d. PRESET button - PRESS.
 - e. Repeat b through d as necessary to complete frequencies and enter training WOD in memory.
4. WOD - LOAD
 - a. Mode Selector - PRESET.

- b. Channel selector - PRESET to be loaded (20-15) (Hear single beep after each channel 20 through 16 and double beep at 15).
- 5. RECEIVE TOD (Dated TOD not required with single WOD)
- 6. Mode Select - MANUAL.
- 7. Select Net - ABB.BCC where:
 - a. A = A (Active)
 - b. BB.B = Desired Net
(000-004 for Basic HQ,
000-015 for HQ II,
Other numbers invalid -
Hear interrupted tone)
 - c. CC = 00 for Basic HQ
25 for HQ II
50 and 75 invalid (Hear interrupted tone)

COMBAT OPERATIONS MODE (MWODs NOT USED)

- 1. WOD/TOD - Same switch actions as Basic HQ
- 2. Select Net - ABB.BCC where:
 - a. A = A (Active)
 - b. BB.B = Desired Net
 - c. CC = 00 for Basic HQ
25 for HQ II
50 and 75 invalid (Hear interrupted tone)

COMBAT OPERATIONS MODE (MWODs not in memory)

- 1. MWOD function - ACTIVATE
 - a. Mode Selector - PRESET
 - b. Channel Select - 20
 - c. Frequency Select - 220.025
 - d. PRESET button - PRESS (Hear beep)
- 2. MWODs - ENTER.
 - a. Mode Select - MANUAL.
 - b. Frequency Select - Enter elements starting with channel 20.
 - c. TONE button - PRESS (Hear beep).
 - d. Repeat b and c for WOD elements 19 - 15.
 - e. Channel Select - 14.
 - f. Frequency Select - Set date tag for WOD.

- g. TONE button - Press (Hear double beep).
- h. Repeat b through g for each additional WOD (up to six total).

3. VERIFY/OPERATE.

- a. Mode Selector - PRESET
- b. Channel Select - 20
- c. Frequency Select - 220.000
- d. PRESET button - PRESS (Hear beep)

4. MWOD Loading - completed.

WOD/TOD Update (WOD in memory and date is part of TOD)

- 1. Request MICKEY - Same switch actions as Basic HQ.
- 2. Current WOD and TOD are now loaded if radio was in VERIFY/OPERATE mode (220.000 in PRESET 20). An alarm (steady tone) upon going active could indicate the TOD did not have date tag as required or WOD is not current.

WOD/TOD Update (TOD not part of TOD)

- 1. ACTIVATE MWOD - Load mode
 - a. Mode Select - PRESET.
 - b. Channel Select - 20.
 - c. Frequency Select - 220.025.
 - d. PRESET button - PRESS (Hear beep).
- 2. CURRENT DATE - SET.
 - a. Mode Select - MANUAL.
 - b. Channel Select - 01.
 - c. Frequency Select - 3XX.000.
 - d. PRESET button - PRESS (Hear beep).
- 3. VERIFY/OPERATE.
 - a. Mode Select - PRESET.
 - b. Channel Select - 20.
 - c. Frequency Select - 220.000.
 - d. PRESET button - PRESS (Hear beep).
- 4. SELF-START RADIOS CLOCK.
 - a. Mode Select - MANUAL.
 - b. A-3-2-T Switch - Hold in T.
 - c. TONE button - PRESS.
 - d. A-3-2-T Switch - RELEASE.
- 5. REQUEST MICKEY - Same switch actions as Basic HQ

COMBAT OPERATIONS NET SELECTION

1. Mode Select - MANUAL.
2. Select Net - ABB.BCC where:
 - a. A = A (Active)
 - b. BB.B = Desired Net
 - c. CC = 00 for Basic HQ
25 for HQ II
50 and 75 invalid (Hear interrupted tone)

VHF/AM RADIO SYSTEM 56

The VHF/AM radio system consists of a Wilcox 807a transceiver, a control panel and a VHF antenna. The frequency range is from 116.000 - 149.975 MHz. The control panel is located on the left console.

The VHF/AM radio system operates on power from the right DC bus.

VHF/AM Control Panel

The VHF/AM radio control panel, placarded VHF COMM, is located on the left console. For a description of controls and indicators, see figure 1-61.

VHF/AM Radio Operation

To operate the VHF/AM radio, proceed as follows:

1. Set OFF/PWR switch to PWR.
2. Using the center portions of both the OFF/PWR and the VOL controls, set the desired frequency up as displayed in the frequency indicator.

VHF/AM CONTROL PANEL 56

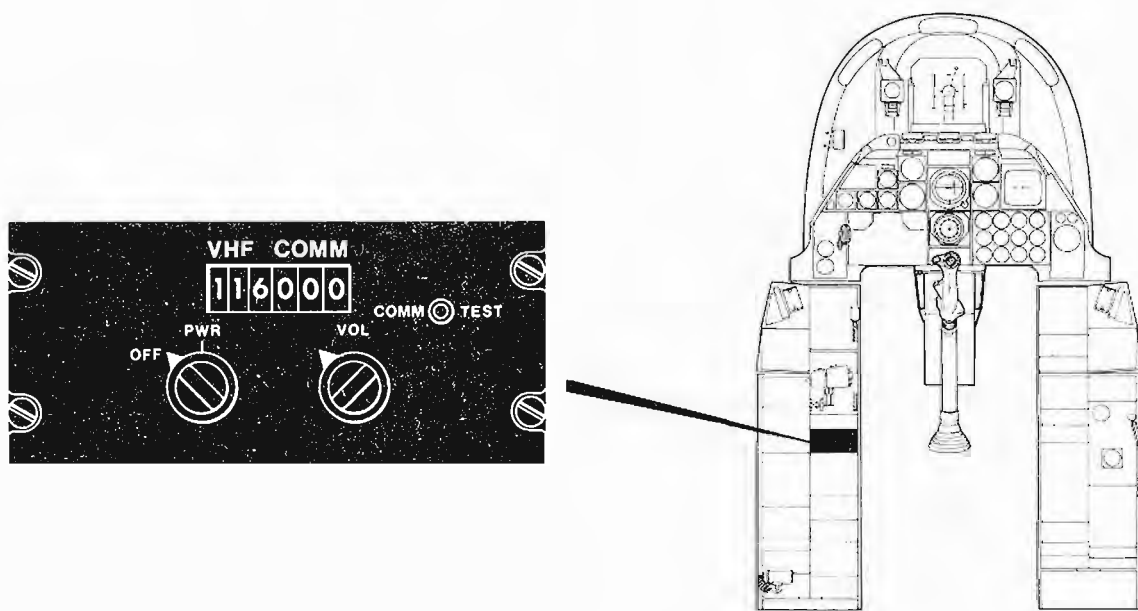

1-10A-1-26

<u>Control</u>	<u>Function</u>
Frequency indicator	Displays selected VHF frequency.
COMM TEST button	Disables the receiver squelch circuit.
VOL control	Adjusts the output level of the receiver.
Frequency selector knobs	Sets the transceiver to a desired frequency.
OFF/PWR switch	Mounted concentrically with the megahertz frequency selector knob, is used to control the application of right DC bus power to the VHF/AM transceiver.

Figure 1-61

3. At the intercom panel, set the rotary selector switch to VHF.

4. If signals are not being received on the selected frequency (channel), depress COMM TEST button and listen to the frequency briefly. When the COMM TEST button is pressed, the receiver's squelch is disabled and receiver background noise and weak signals below the squelch cut off (if present) will be heard. The COMM TEST does not test transmitter operation.

5. Adjust VOL control to a desired level.

VHF/FM RADIO SYSTEM 56

The VHF/FM radio system provides two-way voice communications between air-to-air and air-to-ground VHF/FM radio stations. The system also provides homing information on the ADI. The system can be tuned to any one of 920 channels, spaced 50 KHz apart, from 30 - 75.95 MHz and is fully compatible with secure communications equipment (KY-28). The VHF/FM radio system consists of a receiver/transmitter, a control panel and two antennas, one for communications and the other for homing. Power is supplied by the right DC bus.

VHF/FM Control Panel

The control panel (figure 1-62) contains a mode selector switch for tuning the radio, and for selecting either the TR or HOME mode, four frequency (channel) selectors, a volume control, and squelch mode selector.

The normal transmit/receive mode is operative when the mode selector on the control panel is set to TR.

FM Homing Capability

When the mode selector switch is in HOME, the FM HOMING light on the navigation mode select panel (figure 1-41) comes on. LSS 33, or LSS, MAN, NAV, or ILS 46 modes on the navigation mode select panel override the FM homing mode because the same display on the ADI is used. In the homing mode, FM signals are analyzed to determine signal strength and direction. If the received signals are insufficient to open the squelch circuits (carrier or tone), the course warning flag on the ADI will remain in view. When the received signals are adequate to open the squelch, the course warning flag is driven from view. When the SQUELCH switch is in DIS,

the course warning flag is always in view. FM homing displays on the ADI are described under FM Homing ADI Display, in this section.

VHF/FM Radio Operation

To operate the VHF/FM radio, proceed as follows:

1. Set the intercom rotary selector switch to FM.
2. Set the function selector knob on VHF/FM control panel to TR.
3. Adjust the frequency controls for the desired operating frequency; a channel changing tone should be heard in the headset during tuning.
4. Set squelch control to DIS; noise will be received in headset.
5. Set squelch control to CARR; squelch will open only when a carrier signal is received by the radio set.
6. Set squelch control in TONE; squelch will open when a carrier signal modulated by a 150 Hz tone is received.
7. After a 2-second warmup, slide the MIC switch to UP and talk into the microphone. Sidetone is heard in the headset. Adjust VOL control for comfortable volume level.

AN/ARC-186(V) VHF/AM AND VHF/FM RADIOS 57

The two AN/ARC-186 (V) radios installed in the aircraft to provide VHF/AM and VHF/FM capability are identical. Each radio has been preset to provide dedicated VHF/AM and VHF/FM operation and this cannot be changed by the pilot. If the wrong frequency band is selected on the control panel a tone will be heard.

AN/ARC-186(V) VHF/AM RADIO SYSTEM 57

The AN/ARC-186(V) VHF/AM radio system consists of an AN/ARC-186(V) receiver-transmitter, a control panel, and a VHF/AM antenna. The normal frequency range of the VHF/AM system is from 116.000 - 151.975 MHz. However, the VHF/AM will operate in receive only mode between 108.000 - 115.975 MHz but a slight reduction in reception range may be experienced. The control panel has a

VHF/FM CONTROL PANEL 56

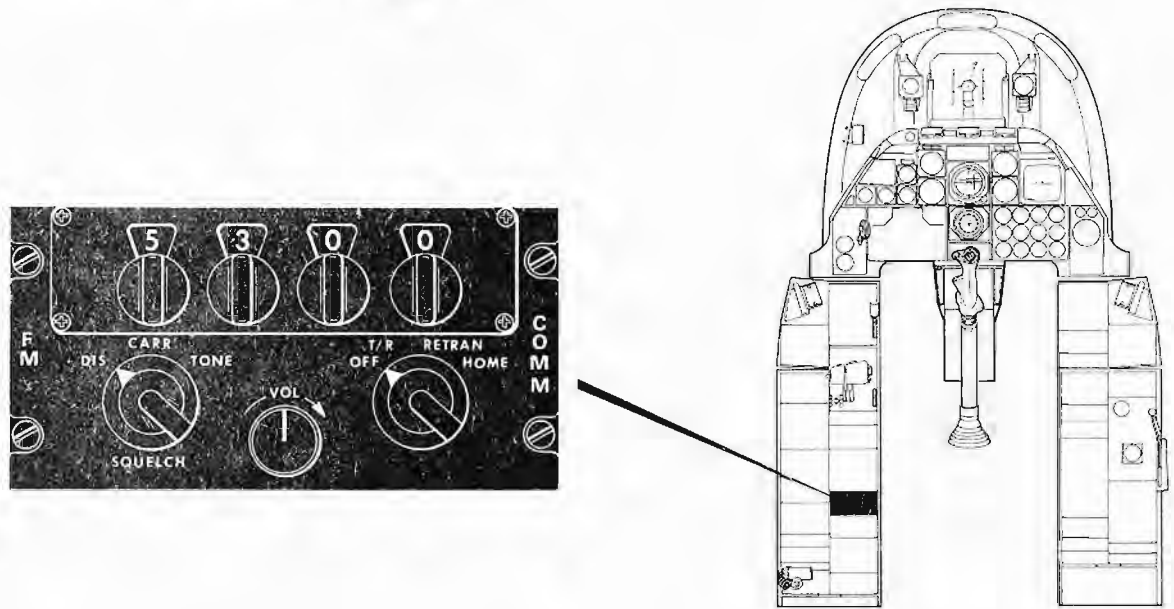

1-10A-1-27

<u>Control</u>	<u>Position/Display</u>	<u>Function</u>
Frequency selectors	—	Select and display associated digit of the operating frequency.
Mode selector	—	Applies power to the radio and selects mode of operation.
	OFF	Turns off primary power.
	TR	Applies power. Radio operates in normal (transmit/receive) communications mode.
	RETRAN	Not used.
	HOME	Applies power. Radio operates in the homing mode.
VOL control	—	Adjusts level of audio output.
SQUELCH switch	—	Selects desired squelch mode.
	DIS	Squelch circuits are disabled and the squelch remains open (audio is heard).
	CARR	Squelch circuits open in presence of any carrier.
	TONE	Squelch opens only on selected signals with tone modulation.

Figure 1-62

20-channel preset capability with an emergency (guard) channel provision. The VHF/AM radio system operates on power from the right DC bus.

AN/ARC-186(V) VHF/FM RADIO SYSTEM 57

The AN/ARC-186(V) VHF/FM radio system provides two-way voice communications between air-to-air and air-to-ground VHF/FM radio stations, and an emergency (guard) channel provision with an automatic switchover from FM CIPHER to FM PLAIN communications whenever the VHF/FM emergency mode is selected. The system also provides homing data relative to the selected station in the form of visual displays on the ADI. The system can be tuned within the tactical FM band of 30 - 76 MHz. Operation above 76 MHz may be possible, but should not be attempted due to the design limits of the VHF/FM antenna. The VHF/FM radio system consists of an AN/ARC-186(V) receiver-transmitter, a control panel having a 20-channel preset capability, and two antennas, one for communications and the other for homing. Power is supplied by the right DC bus.

VHF/AM and VHF/FM Radio Control Panels

The VHF/AM and VHF/FM radio control panels are located on the left console, and described and illustrated in figure 1-63.

VHF/AM and VHF/FM Common Radio Operations 57

MANUAL FREQUENCY SELECTION

Manual frequency selection is accomplished as follows:

1. Mode selector knob — TR.
2. Frequency control/emergency select knob — MAN.
3. Frequency selector knobs — Set desired frequency.

LOADING PRESET CHANNELS

Frequencies can be preset for 20 channels. Loading of a preset channel is accomplished as follows:

1. Mode selector knob — TR.
2. Frequency control/emergency select knob — MAN.

3. Frequency selector knobs — Rotate until desired frequency is obtained.

4. Preset channel selector — Rotate until the desired channel number is obtained.

5. Load pushbutton — Depress.

PRESET CHANNEL SELECTION

Selection of a preset channel is accomplished as follows:

1. Mode selector knob — TR.
2. Frequency control/emergency select knob — PRE.
3. Preset channel selector — Rotate until the desired channel number is obtained.

EMERGENCY GUARD OPERATION

1. Mode selector knob — TR.
2. Frequency control/emergency select knob — EMER AM (121.5 MHz) or EMER FM (40.5 MHz).

VHF/AM AND VHF/FM RADIO TURN-ON PROCEDURE

1. Mode selector knob — TR.
2. On intercom control panel, set rotary selector switch to VHF or FM, as desired. Adjust VOL control and appropriate monitor volume control to a desired level.
3. Frequency control/emergency select knob — MAN. Manually select a frequency. Check for warning tone in the headset. Adjust VOL control for a desired level.
4. Squelch disable/tone select switch — SQ DIS. Noise will be received in headset.
5. Squelch disable/tone select switch — Center position (receiver noise in headset disappears). Squelch will open only when a carrier signal is received by the receiver-transmitter.
6. Load preset channels as required or manually set in required frequency.
7. After a 2-second warmup, slide the MIC switch to UP and talk into the microphone; sidetone is heard in the headset. Adjust VOL control for comfortable volume level.

AN/ARC-186(V) VHF/AM AND VHF/FM CONTROL PANEL 57

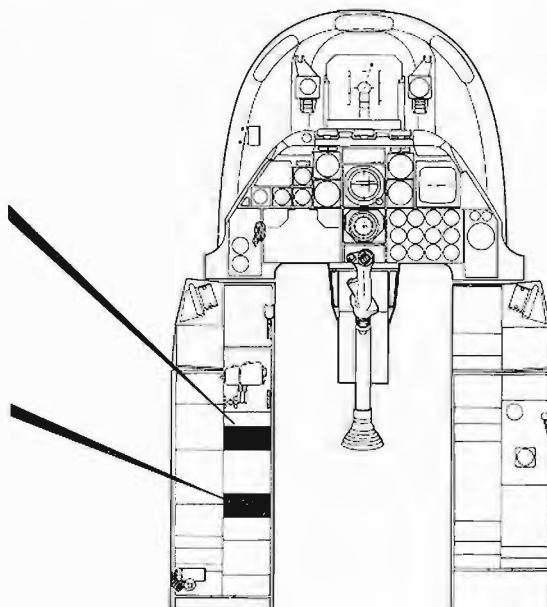
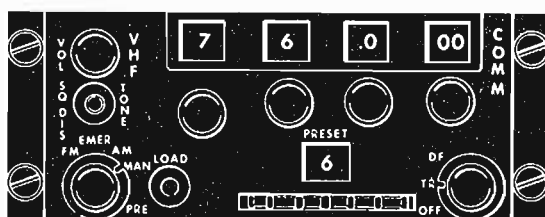
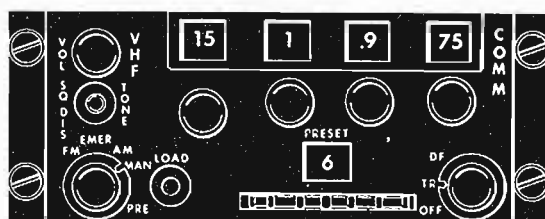

1-10A-1-29

<u>Control or Indicator</u>	<u>Position or Display</u>	<u>Function</u>
VOL control knob	—	Adjusts the audio output.
Frequency selector knobs	—	Select receiver-transmitter frequency.
Frequency indicator	—	Indicates frequency selected by the frequency selector knobs.
Mode selector knob	OFF	Disables the receiver-transmitter.
	TR	Enables the transmit/receive modes.
	DF	Enables FM homing (VHF/FM radio only).
Preset channel selector	—	Selects preset channel from 1 - 20.

Figure 1-63. (Sheet 1 of 2)

<u>Control or Indicator</u>	<u>Position or Display</u>	<u>Function</u>
Load pushbutton	Depress	Inserts manually selected frequency into selected preset channel.
Frequency control/ emergency select knob	EMER FM	Selects a prestored guard channel (VHF/FM radio only).
	EMER AM	Selects prestored guard channel (VHF/AM radio only).
	MAN	Enables manual frequency selection.
	PRE	Enables preset channel selection.
Squelch disable/ tone select switch	SQ DIS	Disables squelch.
	Center	Enables squelch.
	TONE	Transmits tone of approximately 1000 Hz. Switch is spring-loaded to the center position.

Figure 1-63. (Sheet 2 of 2)

FM Homing Capability (VHF/FM Radio Only)

When the mode selector knob on the VHF/FM control panel is in DF, the receiver-transmitter switches to the home mode, and the FM HOMING light on the navigation mode select panel (figure 1-41) comes on if the LSS, MAN, NAV, or ILS [46]; or TISL [62] modes on the navigation mode select panel have not been selected. The LSS, MAN, NAV, and ILS [46]; or TISL [62] modes override the FM homing mode because they use the same display on the ADI. If the received signals are insufficient to open the squelch circuit, the course warning flag on the ADI will remain in view. When the received signals are adequate to open the squelch, the course warning flag is driven from view. When the squelch disable/tone select switch on the VHF/FM control panel is in SQ DIS, the course warning flag is always in view.

FM Homing ADI Display

The bank steering bar of the ADI will indicate course deviation to the left or right of the centerline, relative to the selected station. Turning the aircraft toward the bank steering bar will correct the deviation. Initially, the pitch steering bar will line up (approximately) with the second dot below the centerline as marked on the left side of the ADI. As the aircraft approaches the station, the pitch steering bar will move up toward the

centerline in accordance with the increasing strength of the received signal. If the station is in the opposite direction (aircraft flying away from station), the pitch steering bar will move down from the centerline towards the second dot. When not in the DF mode, the ADI bank and pitch steering bars and course warning flag are stowed out of view.

SECURE VOICE COMMUNICATIONS SYSTEM

The KY-28 or KY-58 secure voice system (15, FO-2) provides for either plain or cipher communications on the UHF and the VHF/FM radios. The KY-28 is not compatible with the active mode of HQ whereas the KY-58 can be used either in the active mode or the inactive (non HQ) mode of the HQ UHF radio system. The KY-28 or KY-58 will switch over from CIPHER TO PLAIN COMMUNICATIONS whenever GUARD is selected on the UHF radio or whenever EMER is selected on the VHF/FM radio [57].

Operation of the KY-28 or KY-58 System

1. KY-28 or KY-58 daily key – Set.
2. UHF and FM radios – Set.
3. Interphone panel – Set.
 - a. FM monitor switch – Pull out.
 - b. UHF monitor switch – Pull out.

4. Ciphony panel — Set.
 - a. Power switch — ON.
 - b. Mode switch — PLAIN (indicator light on).
 - c. Delay switch — OFF.
5. Make test transmissions.
6. Mode switch — C/RAD 2-(FM) or C/RAD 1-(UHF) (corresponding light will come on).

When the mode switch is set to C/RAD 2 or C/RAD 1, an automatic alarm procedure is initiated. A constant tone is heard in the headset, and after approximately 2 seconds, the constant tone will change to an interrupted tone.

7. Mic switch — UP or DOWN as required, then release.

The interrupted tone will no longer be heard. The system is now in standby condition ready to transmit and receive.

8. To transmit — Mic switch UP or DOWN as required.

Do not talk for approximately 1/2 second. At that time a beep will be heard which indicates the receiving station is capable of receiving.

LIGHTING SYSTEM

EXTERIOR LIGHTS

The exterior lighting system is comprised of the lights used for navigation (formation and position lights), landing, taxi, and air refueling. Controls are provided for mode of operation and intensity of the lights.

Master Exterior Light/Missile Video Polarity Switch

The master exterior light/missile video polarity switch (figure 1-4), is a three-position switch mounted on the left engine throttle grip. The forward position controls the following:

- Retention of illumination level set on panel for formation lights, nose floodlights and nacelle floodlights
- Changes position lights from bright to dim steady
- Removes power from the anti-collision solenoid switch so that the switch automatically returns to OFF.

The centered position of the master exterior light switch turns off position lights, formation lights, nose floodlights, nacelle floodlights, and anti-collision lights regardless of control panel settings. To reactivate the anti-collision lights following turnoff by the master exterior light switch, the master exterior light switch must be moved aft and the anti-collision switch on the lighting control panel must be reset. The aft position allows for operations of the lights as set on the control panel.

The switch is also used during AGM-65 missile launches, and becomes dedicated to the missile video polarity selection capability whenever an AGM-65 missile loaded station is selected. The state of the position, formation, nose floodlights, nacelle floodlights, and anti-collision lights existing at the time of AGM-65 missile station selection will be maintained, regardless of any subsequent repositioning of the master exterior lighting/missile video polarity switch. Any alteration of the position, formation or anti-collision lighting conditions must be made on the lighting control panel (figure 1-64), whenever AGM-65 missile stations are selected. The exterior lighting conditions in existence prior to, and during AGM-65 missile station selection will be altered upon missile station deselection whenever the master exterior light/video polarity switch is left in a position (as a result of video polarity selections) other than that position setting initially existing for master lighting control. The switch is powered by the right DC bus.

Landing and Taxi Lights

The landing and taxi lights consist of two separately powered lights located on the nose gear strut. The landing light is mounted on the upper, nonrotating section of the strut. The taxi light is mounted on the steerable section of the strut to provide directional lighting for taxiing. Electrical circuits to the lights are interlocked to insure operation only when the nose gear is down and locked. Both lights are used as landing lights, but on the ground only the taxi light is necessary. The lights are controlled by the landing/taxi light switch on the instrument panel, above the landing gear handle. The landing light is powered by the right AC bus. The taxi light is powered by the left AC bus.

Landing/Taxi Lights Switch

The landing/taxi lights switch (31, figure FO-1), is a three-position toggle switch, located on the instrument panel, and placarded LIGHTS, with positions

LIGHTING CONTROL PANEL

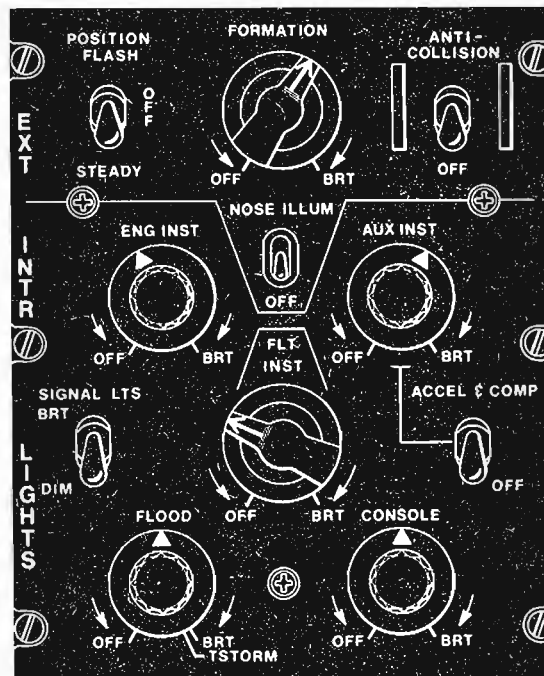
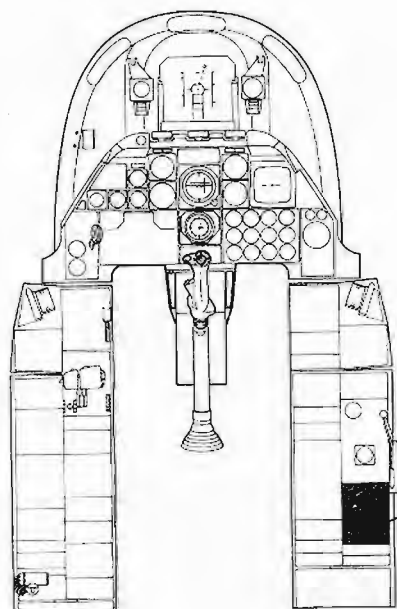

Figure 1-64

1-10A-1-63

TAXI, LAND, and OFF. Placing the switch in TAXI causes the lower light on the nosewheel strut to come on. In LAND position, both lights come on. The OFF position removes power from both lights.

Position Lights

The position lights consist of red (left side) and green (right side) lights in the wing tips, and a white light at the fuselage tail. A dimmer control and a steady/flash/off control switch are provided to activate and control the position lights. In addition, the position lights may be overridden by the master exterior lighting control switch on the left throttle grip (figure 1-4). The position lights are powered by the right DC bus.

Position Lights Switch

The position lights switch, placarded POSITION (figure 1-64), is located on the lighting control panel on the right console. The switch has three positions, placarded FLASH, STEADY, and OFF. The position lights may be turned off with either the position light switch or by the master exterior lighting control

switch. In addition, the position lights may be dimmed with the master exterior lighting control switch.

Strobe Anti-Collision Lights

The strobe anti-collision lights are white, high intensity lights, mounted at each wing tip and on the fuselage tail. The strobe lights are powered by the left DC bus, and are synchronized to flash simultaneously.

Strobe Anti-Collision Lights Switch

The wing tip and tail strobe anti-collision lights are controlled by a two-position toggle switch, on the lighting control panel. The switch is placarded ANTI-COLLISION and OFF (figure 1-64). The switch is solenoid-held in ANTI-COLLISION. In ANTI-COLLISION, left DC bus power operates the strobe lights.

Formation Lights

White formation lights are installed on the lower outside of each vertical fin and at the top and bottom of

the fuselage aft of the cockpit, to serve as a reference for formation flying. The formation lights are powered by the left AC bus.

FORMATION LIGHTS **106**

On **106** aircraft, white formation lights are installed on the lower outside of each vertical fin and at the top and bottom of the fuselage aft of the cockpit. Green electroluminescent formation lights are installed on the outside of each vertical fin, at top and bottom of aft fuselage between vertical fins, behind and both sides below the cockpit on the fuselage and wing tips. These lights serve as a reference for formation flying. The formation lights are powered by the left AC bus.

Formation Lights Switch

The formation lights are controlled by a rotary dimmer control, placarded FORMATION (figure 1-64), located on the lighting control panel. The formation switch has two placarded range positions, with OFF position at the extreme CCW position, and BRT in extreme CW position. The switch is powered by the left AC bus.

Nose Floodlights

A lighting fixture is installed in each aileron actuator fairing to illuminate both sides of the fuselage nose section. These lights are used as formation lights and during air refueling, and are controlled by the formation lights switch. A separate switch is provided for turning off the nose floodlights only.

Nose Floodlights Switch

The nose floodlights switch (figure 1-64), is a two-position switch, placarded NOSE ILLUM and OFF. The nose floodlights come on when the formation lights switch is out of OFF and the nose floodlights switch is in NOSE ILLUM. OFF position is used when reflective light may be disturbing to the pilot. The switch is powered by the left DC bus.

Nacelle Floodlight

A nacelle floodlight is incorporated with the top fuselage formation light. This light floodlights the engine nacelle area during air refueling. The nacelle floodlight is controlled and dimmable by the air fueling light switch. So that the light will also be available during formation flying, it is not interlocked with the air refuel control. The second lamp functions as the formation light and is controlled by the formation lights switch.

Nacelle Floodlight Control

The nacelle floodlight on-off capability and lighting intensity are controlled by the rotary selector switch, placarded RCVR LT, located on the fuel system control panel (figure 1-10) on the left console. The switch is powered by the left DC bus.

Air Refueling Lights

Air refueling (slipway) lights, consisting of two flush lamp assemblies, are located on each side of the UARRSI slipway to illuminate the slipway and receptacle. The slipway lights are powered by the left DC bus.

Air Refueling Lights Switch

The air refueling (slipway) and nacelle floodlights are controlled by a rotary selector switch, placarded RCVR LT, located on the fuel system control panel (figure 1-10) on the left console. With the RCVR LT switch, the pilot may select any desired level of illumination, from OFF to BRT. The switch is powered by the left DC bus.

INTERIOR LIGHTING

Primary interior lighting is provided for instruments, control panels, and information placards. Secondary interior lighting is provided by low-intensity floodlights for the instrument panel, left and right consoles and controls. A utility light fixture (19, figure FO-2), with a plug-in attachment, is installed at the aft portion of the left console for general utility purposes. Thunderstorm lights are provided to illuminate the instrument panel and consoles.

Separate cockpit controls are provided for variable control of illumination levels by areas. These controls are located on the lighting control panel (figure 1-64). The standby compass and accelerometer lights are controlled with the auxiliary instruments through a separate switch. A bright-dim switch is provided for the warning/caution/advisory signal lights with automatic return to dim. Variable illumination of the armament control panel, HUD panel, TV monitor and TISL panel is accomplished by an independent control located on the armament control panel. A signal lights test button is provided to test certain warning/caution/advisory signal lights.

To achieve balanced illumination levels between adjacent instruments, control panels, etc., screw-driver adjustable controls are provided. These controls are located in the left electrical system load center.

Engine Instrument Lights Control

The ENG INST lights control (figure 1-64), powered by the auxiliary AC essential bus, controls the intensity level of the panel lights for the following:

- Left and right ITT indicators
- Left and right engine oil pressure indicators
- Left and right engine fuel flow indicators
- Left and right engine core speed indicators
- Left and right engine fan speed indicators
- APU tachometer
- APU temperature indicator

Flight Instruments Light Control

The FLT INST light control (figure 1-64), powered by the auxiliary AC essential bus, controls the intensity level of the panel lights for the following:

- ADI
- HSI
- Airspeed indicator
- VVI
- AOA indicator
- Clock
- Navigation mode select switch identifiers
- Altimeter

The flight instrument light control must be rotated CW of the 9 o'clock position for the signal light switch to function.

Auxiliary Instrument Lights Control

The AUX INST lights control (figure 1-65), powered by the left AC bus controls the intensity level of the panel lights for the following:

- Hydraulic pressure indicators

- Flap position indicator
- Fire extinguisher panel
- Fuel quantity panel and indicator
- Emergency jettison lighting plate
- Radio call number
- Standby compass
- SAI
- Accelerometer
- Landing gear control panel

Accelerometer and Compass Lights Switch

The accelerometer and compass lights are controlled by a two-position toggle switch, placarded ACCEL & COMP and OFF (figure 1-64). The switch is powered by the left AC bus.

Floodlights Control

The floodlights control (figure 1-64), provides variable intensity level to the low-intensity floodlights. These lights are powered by the auxiliary DC essential bus when the emergency floodlight switch is in OFF. There are low-intensity floodlights arranged along each side of the cockpit. The intensity level of each floodlight increases when the floodlights control is turned CW. In addition to the low-intensity floodlights, thunderstorm lights are provided. The thunderstorm lights come on when the floodlights control is turned beyond the maximum BRT detent to TSTORM. The thunderstorm lights are powered by the auxiliary DC essential bus. All low-intensity and thunderstorm floodlights are shaded to prevent glare.

Emergency Floodlights Switch

The emergency floodlights switch (figure 1-11), is a two-position switch, placarded EMER FLOOD and OFF. EMER FLOOD causes the cockpit floodlights to come on full bright using power from the battery bus. In this position the floodlights control is inoperative. In OFF, the floodlight intensity is controlled by the floodlights control.

CAUTION LIGHT PANEL

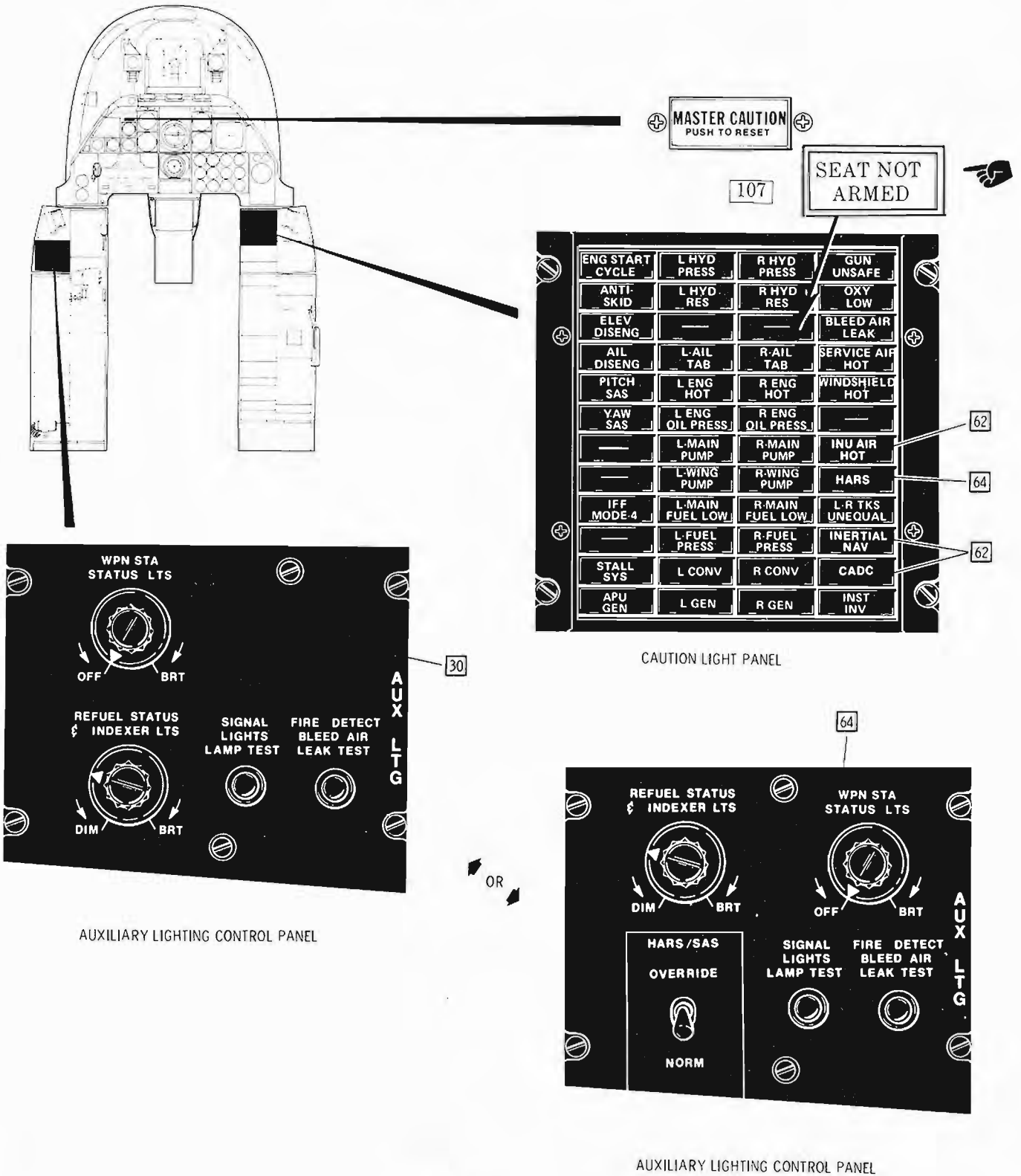

Figure 1-65.

Console Lights Control

The console lights control (figure 1-64), powered by the left AC bus, controls the intensity level of the lights of the following:

- Emergency flight control panel
- Throttle quadrant panel
- SAS panel
- Fuel system control panel
- Canopy control switch lighting plate
- Seat control switch lighting plate
- UHF radio panel
- VHF/AM radio panel
- VHF/FM radio panel
- Antenna select control panel
- Intercom control panel
- IFF control panel
- Circuit breaker panel
- Electrical power control panel
- Chaff/flare control panel [45]
- ILS control panel [47]
- TACAN control panel
- HARS control panel
- Oxygen control panel
- Environment control panel
- Lighting control panel
- CDU [62]
- CTVS/AVTR control panel [69]

Signal Lights Switch

The signal lights switch (figure 1-64), placarded SIGNAL LTS, is a two-position spring-loaded toggle

switch, powered by the auxiliary DC essential bus that provides for either of two illumination levels, BRT and DIM, for warning, caution and advisory signal lights, except for approach indexer and air refuel status lights. The warning, caution, and advisory signal lights are reset to bright automatically when the FLT INST lighting control is initially turned on. As the control is turned the lights will return to dim. All signal lights are reset to bright automatically when the thunderstorm lights circuit is energized, or the signal lights bus power is lost.

Signal Lights Test Button

The signal lights test button (figure 1-65), placarded SIGNAL LIGHTS LAMP TEST, on the auxiliary lighting control panel, is a press-to-test button. The signal lights test button is powered by the auxiliary DC essential bus. Only those test circuits with the appropriate electrical power available will be activated when the button is depressed. Those items below, which operate when only battery power is available, are marked with an asterisk (*); all others require power from the generators, converters, or some external source. Depressing the button tests the landing gear audio warning and lights the lamps in the following signal lights:

Instrument panel:

- Gun ready
- *Steering engaged
- Marker beacon
- *Marker beacon [33]
- *Canopy unlocked
- *Master caution press-to-reset
- *Landing gear condition (L-SAFE, N-SAFE, R-SAFE)
- *Landing gear handle
- Navigation mode select panel TCN and ILS [33] ; PT STOW, TCN, ILS, NAV, LSS, MAN, UHF, and FM [46] ; TCN, NAV CRS, MAN, ILS, LOC, TISL, UHF and FM [62]

HUD malfunction (only when the HUD mode selector switch is out of OFF).

Windshield bow:

Approach indexers-test bright only, regardless of signal light switch position.

Air refuel READY, LATCHED, DISCONNECT-test bright only, regardless of signal light test switch position.

Pedestal:

TISL (TISL/AUX, OVERTEMP, DET/ACD, TRACK) (if pod installed and on).

Left console:

*Emergency control panel (L-AIL, R-AIL, L-ELEV, R-ELEV)

*SAS control panel (TAKEOFF TRIM)

TV monitor BIT light

Right console:

*Caution light panel

*Chaff/flare control panel ready lights 45

When the SIGNAL LIGHTS LAMP TEST button is released, all signal lights not already activated through normal system operation will go off. The SIGNAL LIGHTS LAMP TEST button does not test the fire warning lights or armament control panel lights.

Cockpit Utility Light

The cockpit utility light (19, figure FO-2) is a standard light fixture with self-contained brightness control installed at the aft portion on the left console. It functions as a general utility light and as an emergency lighting source. The plug-in type attachment and extensible cord permits removal and movement of the fixture by the pilot to direct light to any desired area within the cockpit. An additional plug-in retainer base is affixed to the left canopy bow to permit directing light to any desired area without the need for the pilot to hold the utility light. The cockpit utility light is powered by the auxiliary DC essential bus.

Armament System Lights Control**PANEL LIGHTS CONTROL**

A lighting control on the armament control panel (figure 1-66), placarded PNL LTS, powered by the AC armament bus, adjusts the intensity level of the panel lights on the following armament system lighting placards.

- Armament control panel
- HUD control panel
- TV monitor control panel
- TISL control panel

ARMAMENT LAMP TEST PUSHBUTTON

The armament LAMP TEST pushbutton on the armament control panel (figure 1-66) simultaneously illuminates all armament control panel status displays and electric fuzing HV test indicator to check the lamps. The pushbutton switch is powered by the right AC bus.

Approach Indexer and Air Refueling Status Lights Control

A lighting control, on the auxiliary lighting control panel (figure 1-65), placarded REFUEL STATUS & INDEXER LTS, is provided for controlling the intensity level of the AOA indexer, and air refuel signal lights (3 and 6, figure FO-1) located in the windshield area. The AOA indexer lights are powered by the right DC bus, and the air refuel lights are powered by the left DC bus. The control has no OFF position; it is only possible to achieve a dim level.

Master Caution and Caution Panel Lights

The caution light panel (figure 1-65), on the right console, consists of a series of yellow fault identity display lights. The master caution light is placarded MASTER CAUTION PUSH TO RESET. The first indication of malfunction will be a light on the caution light panel flashing simultaneously with the MASTER CAUTION light.

ARMAMENT CONTROLS

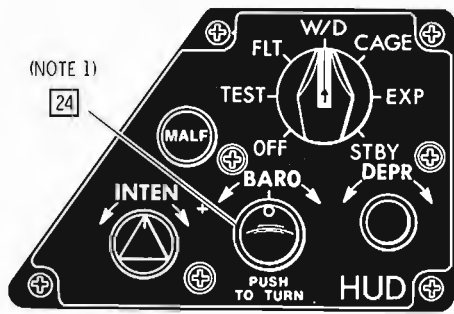

HUD CONTROL PANEL



TV MONITOR

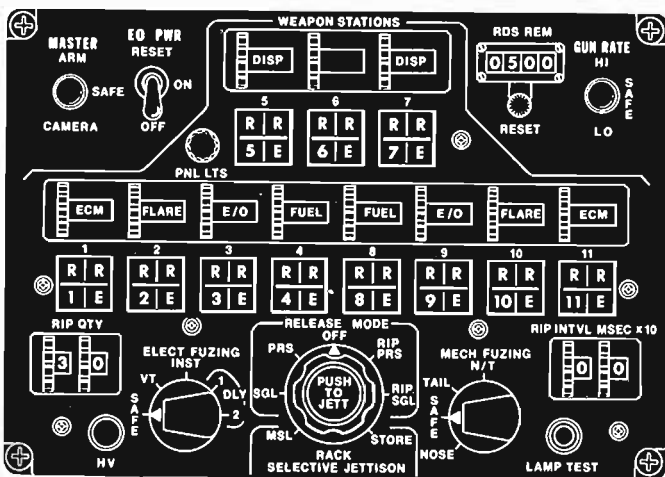

ARMAMENT CONTROL PANEL

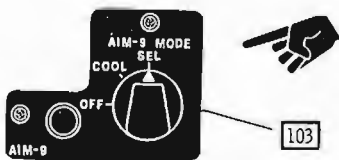

103

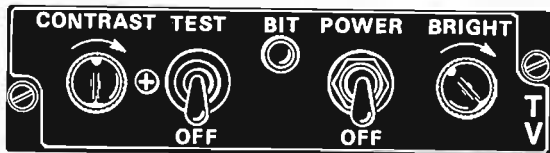

TV MONITOR CONTROLS

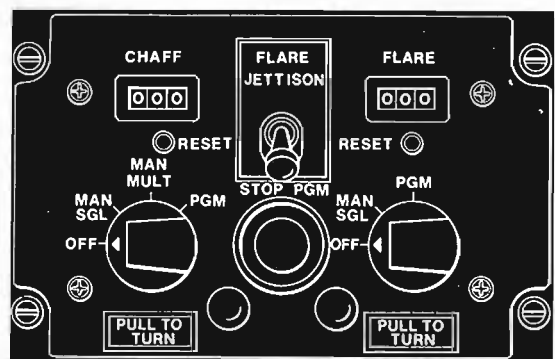

CHAFF/FLARE CONTROL PANEL

45

NOTE:

- ON 25 THE BARO SETTING CONTROL IS ON THE AAU-341A ALTIMETER.

Figure 1-66. (Sheet 1 of 2)

ARMAMENT CONTROLS

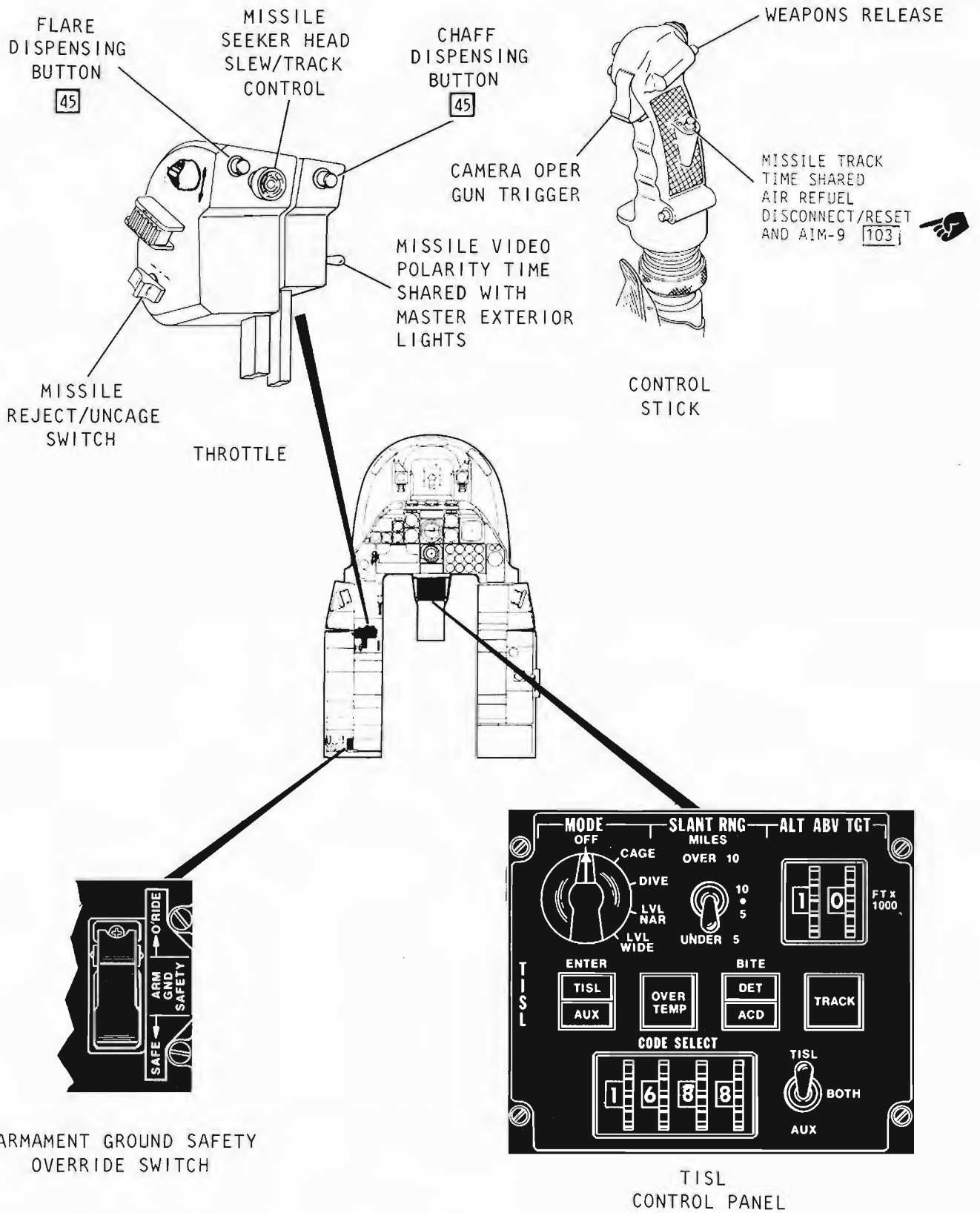

Figure 1-66. (Sheet 2 of 2)

1-10A-1-4.2

Each light on the caution light panel will change from flashing to steady illumination when the master caution light is reset, at which time the master caution light will go off. The caution lights will remain on until the fault has been corrected. Each of the caution light panel lights is described in the applicable system description. The master caution and the caution lights are powered by the DC essential bus, except the GUN UNSAFE light, which is powered by the DC armament bus.

NOTE

- Upon initial application of power, all faults present at the time will come on steady and the master caution light will not come on. Any new fault(s) thereafter will come on flashing and the master caution light will come on. After acknowledging the new fault(s) by resetting the master caution light, the legend(s) will become steady and the master caution light will go off.
- Intermittent faults will cause flashing lights and the master caution light will come on. When fault disappears, the panel light and the master caution light go off automatically.
- To change bulbs, depress individual light fixture and allow to release. The fixture will extend 1/16-inch. Using the finger grips on either side of the legend cap, carefully pull the light assembly housing to the fully extended position. Rotate the fixture to expose the lamp bases and remove and replace lamps as required. Reset fixture in panel and fully depress assembly until flush with panel using one continuous motion.

CAUTION

- Removing caution panel legends with power applied may cause a power surge that will damage the annunciator panel. When this happens, all caution lights will be inoperative. The master caution light should still function.

ARMAMENT SYSTEM

For detailed information on the Armament System, refer to TO 1A-10A-34-1-1.

STORES CARRIAGE CAPABILITY

The aircraft has eleven nonjettisonable external pylon stations, three of which have the capability of carrying external fuel tanks. Forward firing ordnance may be carried on pylon stations 2 thru 10. [103] AIM-9 missiles may be carried on stations 1 and/or 11. Conventional munitions may be carried on all pylons. Seven of the pylons house a bomb rack, which has both 14- and 30-inch suspension hooks. The two most outboard wing pylons on each wing contain a bomb rack which has 14-inch suspension hooks. Each ejection rack assembly has provisions for bomb arming, release, and a forced ejection mechanism. This provides for carriage of multiple bomb loads at those stations which are structurally capable of the load requirements. On [45], four chaff/flare dispensers are installed in each main landing gear pod and each wing tip such that the payloads are dispensed in a downward direction.

30MM GUN SYSTEM

The gun subsystem consists of a seven-barrel GAU-8/A 30mm Gatling gun and a double-ended linkless feed system with capacity up to 1,350 rounds of percussion primed ammunition. Most aircraft have a helix installed in the drum assembly which limits the system capacity to 1,174 rounds of percussion primed ammunition. The gun system retains all spent cases or dud rounds. The gun system is electrically controlled and hydraulically driven. The gun-drive motors provide dual firing rate and are pressurized from the two independent hydraulic systems. If one aircraft hydraulic system fails or one hydraulic drive motor is inoperable, low-rate operation can be obtained with the operative hydraulic drive motor by selecting high rate. On [82], there is no LO gunfire rate, the GUN RATE switch is placarded HI and SAFE.

The system is safed by a single safing pin which prevents the firing pins from striking the rounds of ammunition.

CAUTION

- Flight testing has shown that engine disturbances can be caused by gun gas ingestion during gunfiring. If an engine disturbance does occur during gunfiring the only cockpit indication may be a momentary drop in fan speed. When firing it may be possible for multiple engine disturbances to occur causing an engine stall/overtemperature. In this condition, refer to Engine Malfunction emergency procedures in Section III.

NOTE

On [82] aircraft firing missions are authorized with existing muzzle clamp assembly installed in lieu of the gun gas diverter device. The firing rate with this configuration is 3900 (+200, -600) rounds per minute with gun rate HI.

Gun Ready Light

The gun ready light, placarded GUN READY (13, figure FO-1), is a green light located on the instrument panel. Refer to TO 1A-10A-34-1-1 for operation of the GUN READY light.

The gun unsafe light, placarded GUN UNSAFE (figure 1-65), is located on the caution light panel. This light will come on approximately 2.5 seconds after release of trigger if the clearing cycle is not completed. The GUN UNSAFE light coming on indicates the possibility that the gun could inadvertently fire. The GUN UNSAFE light is powered by the DC armament bus.

CAUTION

- The trigger should not be depressed when the GUN UNSAFE light is on. Doing so may cause serious damage to the gun system and aircraft.

ARMAMENT GROUND SAFETY OVERRIDE SWITCH

The armament ground safety override switch (22, figure FO-2), is a guarded two-position switch, placarded ARM GND SAFETY with positions SAFE and ORIDE. The ORIDE position overrides the ground safety circuit for maintenance purposes.

The ground safety circuit, activated by the DOWN position of the landing gear handle, prevents normal release or arming of ordnance and gun firing circuits.

ARMAMENT CONTROL PANEL

The armament control panel (figure 1-66) is located on the instrument panel. The armament control panel provides switches for selection of weapons stations, control of gun firing rate, arming of selected weapon and gun sight camera circuits, mechanical bomb fusing, AIM-9 mode, selective jettison and release modes, and ripple quantity and interval controls. In addition, the armament control panel contains an ammunition rounds remaining display, an external stores loading display, and readiness indicators. A description of the controls and indicators on the armament control panel is contained in TO 1A-10A-34-1-1.

Weapon Station Select Switches

Eleven weapons station select pushbutton switches on the armament control panel (figure 1-66) allow pilot selection of a particular weapon station. Three different colored alphanumeric lights indicate the status of each weapons station. The selected station ready light(s) will show steady green for selective jettison and normal release modes to indicate the master arm switch is in ARM, station is selected, and store is "armed". The selected station ready light(s) will flash in selective store jettison

mode to indicate the master arm switch is in ARM, station is selected, and store is "safe". Selected station ready light(s) will flash whenever the master arm switch is in ARM, station is selected, and the release mode is MSL or RACK jettison.

On [103], with Master Arm switch in SAFE, AIM-9 Mode switch OFF, and station 1 or 11 selected, steady green ready lights indicate the AIM-9 missile system is in a LIVE fire mode of operation. A steady amber "E" light indicates the AIM-9 Training mode of operation and a blinking amber "E" indicates AIS mode of operation.

Weapon Station Select Switches Dimmer Control

The weapon station select switches dimmer control (figure 1-65) is placarded WPN STA STATUS LTS, with positions OFF and BRT. Rotating the control adjusts the brightness of the weapon station select switches from OFF to full bright. The switch is powered by the right AC bus.

EMERGENCY JETTISON BUTTON

The emergency jettison button (figure 1-66), placarded EXT STORES JETT, is located on the glare shield. Emergency jettison is dual-powered from the DC essential bus with automatic backup from the battery bus. When the EXT STORES JETT button is pressed, external stores on pylon stations 1 - 11 are released in the following sequence:

- Simultaneous with switch actuation -- stations 1, 2, 10, and 11
- 0.5 second after switch actuation -- stations 3, 4, 8, and 9
- 1.0 second after switch actuation -- stations 5, 6, and 7.

NOTE

- The emergency jettison button, once powered, will function with weight-on-wheels regardless of the position of the ground override switch.
- On [45], chaff/flare payloads may be installed in each main landing gear pod and each wing tip. Flare payloads are jettisoned through the use of the FLARE JETTISON switch on the chaff/flare control panel. Chaff payloads cannot be jettisoned.

Refer to TO 1A-10A-34-1-1 for selective jettison procedures.

TRIGGER SWITCH

The trigger switch (figure 1-66) is mounted on the forward upper surface of the control stick grip. The trigger works in conjunction with the MASTER ARM switch on the armament control panel. When the MASTER ARM switch is in CAMERA, the gun camera will be activated by depressing the trigger to the first or second detent. When the MASTER ARM switch is in ARM, the camera will operate when the trigger is depressed to the first or second detent, and the internal and/or external gun pods will fire when the trigger is depressed to the second detent. On **3**, ignition is provided to both engines while the gun trigger is depressed to the second detent and for 30 seconds after gun trigger release. On **4**, ignition is provided to both engines while the trigger is depressed to the second detent and for 1 second after gun trigger release. The gun will not operate unless the landing gear handle is UP or the armament ground safety override switch is in ORIDE (guard up).

WEAPONS RELEASE BUTTON

The weapons release button (figure 1-66) is located on the control stick grip. Depressing the button will release stores from selected pylons which show a green ready light on the armament control panel.

HEAD-UP DISPLAY SYSTEM

The HUD system provides the pilot with a primary and a standby weapon delivery capability, and simplified data display mode as a visual aid for normal flight operation. The HUD system is controlled from the HUD control panel (figure 1-67) on the instrument panel.

All HUD displays are presented on the optical combiner above the instrument panel. The optical combiner is an optical reflecting surface that reflects HUD symbols, projected from a remote CRT, into the pilot's line of vision.

WARNING

- The HUD is not a primary flight instrument; and should not be used as a substitute for the airspeed indicator and altimeter for takeoff and landing.

HUD CONTROL PANEL

The controls and indicators on the HUD control panel are described and illustrated in figure 1-67.

HUD DISPLAY SYMBOLOGY **61**

The HUD display consists of an aiming reticle, pipper, a standby (backup) reticle and pipper, airspeed scale, altitude scale, pitch angle, roll bars, target identification set, TISL diamond and line, gun cross, and depression readout. All HUD display symbols are illustrated in figure 1-68. In all CRT modes of operation, all display symbology, except the TISL diamond, a portion of its associated line, and the gun cross are depressed with the aiming reticle. Altitude data from the altitude computer and pitch and roll data from the HARS are removed from the HUD display when the respective systems sense inaccurate data.

Aiming Reticle and Pipper

The aiming reticle is a 50 mil diameter circle with a 2 mil solid pipper dot at its center. This reticle is caged in azimuth and manually depressible in elevation over a range of +10 to -300 mil referenced to the aircraft armament datum line as governed by the HUD control panel DEPR knob setting.

Gun Cross

When the aiming reticle is positioned to a depression of greater than -61 mil in W/D mode or -183 mil in EXP mode, a gun cross (figure 1-68) positioned at -41 mil will appear.

Standby Reticle

The standby reticle is identical to the primary aiming reticle in size and depression range.

Indicated Airspeed Tape

The indicated airspeed tape (figure 1-68), is a moving scale with a fixed index. The operational range is from 50 - 550 KIAS. The moving portion of this display represents a total of 100 knots full scale with increment marks at each 5-knot interval, and elongated markings at 25-knot intervals.

HUD CONTROL PANEL

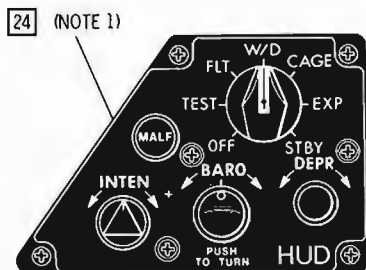

OR

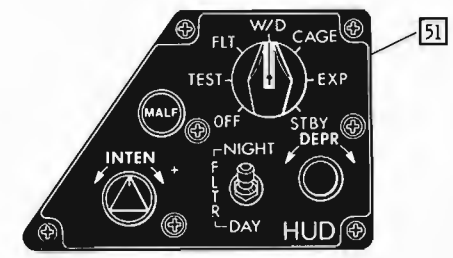

OR

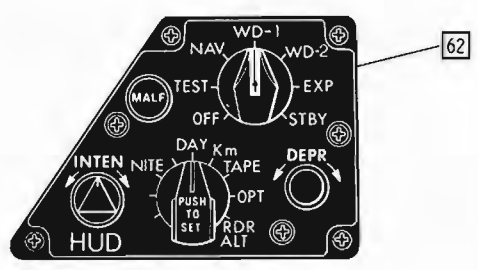

NOTE :

- 1. ON 25 THE BARO SETTING CONTROL IS ON THE AAU - 34/ A ALTIMETER

1-10A-1-15

Control or Indicator	Position or Display	Function
Mode selector switch	OFF	The HUD is completely deenergized.
	TEST	Selects a visual self-test to exercise all HUD functions and the appropriate symbology to detect a subsystem malfunction. See figure 1-68 or 1-69, as applicable.
	FLT 61	Provides a manually depressible pipper, a mil readout, and aircraft pitch, roll, altitude, and indicated airspeed data. Within limits, the flight symbology will follow the pipper depression position. See figure 1-68.

Figure 1-67. (Sheet 1 of 4)

<u>Control or Indicator</u>	<u>Position or Display</u>	<u>Function</u>
Mode selector switch (Cont)	NAV 62	Used during normal point-to-point flight. The display is centered in azimuth and the flight path ladder rotates at the 41 mil depression to display roll. There are two NAV mode displays, INS and HARS. Symbols displayed in the INS NAV (normal) mode are flight path ladder, destination index, TVV, distance to go, time to go, TISL diamond and line, airspeed, altitude, mil depression, pipper, steerpoint, and the heading scale. Setting the function knob to OPT and depressing once (option A) adds vertical velocity to the normal display. Depressing twice (option B) adds vertical velocity, but deletes the destination index, time to go, and distance to go. Symbols displayed in the HARS NAV mode are airspeed, altitude, pipper, TISL diamond and line, pitch angle (boxed), roll bars, and the mil depression. See figure 1-69.
	W/D 61	Provides the same parameters and display format as in FLT mode with the addition of a 50 mil diameter reticle centered about the depressible pipper. A gun cross is provided at -41 mil. If the TISL has achieved a lock on to a laser illuminated ground target, a TISL diamond and line are provided to indicate its relative angular position. When the TISL diamond is close to the aiming reticle, the line is inhibited. See figure 1-68.
	WD-1 62	Designed for forward firing ordnance. There are two WD-1 mode displays, INS and HARS. Symbols displayed in the INS WD-1 (normal) mode are the same as in the NAV (normal) mode, with the addition of a gun cross and aiming reticle. Setting the function knob to OPT and depressing once (option A) adds the flight path angle numeric and deletes the TVV and the destination index. Depressing twice (option B) further deletes heading scale, time to go, and distance to go. For all options the gun cross appears only at reticle depressions of 50 mil or greater. Symbols displayed in the HARS WD-1 mode are the same as the HARS NAV mode with the addition of the gun cross and the aiming reticle. 103 TISL diamond appears when AIM-9 is selected to indicate missile seekerhead position. The gun cross appears only at reticle depressions of 50 mil or greater. See figure 1-69.
	WD-2 62	Designed for dive bombing. There are two WD-2 mode displays, INS and HARS. Symbols displayed in the INS WD-2 (normal) mode are the same as in the WD-1 (normal) mode with the addition of reticle eyebrows, which appear at reticle depressions of 100 mil or greater. All symbology except the destination index, TISL diamond and line, and gun cross drifts in azimuth with the TVV. The pitch ladder rotates at the total velocity vector to display roll attitude. Setting the function switch to OPT and depressing

Figure 1-67. (Sheet 2 of 4)

<u>Control or Indicator</u>	<u>Position or Display</u>	<u>Function</u>
		once (option A), deletes the heading scale, time to go, and distance to go. Depressing the switch twice (option B) deletes the destination index as well. Symbols displayed in the HARS WD-2 mode are the same as the HARS WD-1 mode with the addition of reticle eyebrows at reticle depressions of 100 mil or greater. [103] TISL diamond appears when AIM-9 is selected to indicate missile seekerhead position. Symbology remains centered in azimuth in the HARS WD-2 mode. See figure 1-69.
	CAGE [61]	Same display as in W/D mode except that the aiming reticle and depression angle readout are instantaneously driven to a depression of 70 mil. See figure 1-68.
	EXP	Same as W/D mode on [61], and WD-2 mode on [62], except that the depression angle for the aiming reticle and TISL diamond have been scaled as if the total field of view in elevation is 60°, in lieu of 20°. The depression settings of +10 to -300 mil are now +30 to -900 mil. The mil depression appears in a box. On [62], setting the function knob to OPT and depressing once (option A) deletes heading, time to go, and distance to go. Depressing twice (option B) deletes the destination index as well. See figure 1-68 or 1-69, as applicable.
	STBY	Used as a backup or emergency mode in the event of a CRT or associated electronics malfunction. When STBY mode is selected, a separately generated manually depressible reticle and mil depression are provided. This reticle is depressible over the same range as that available in primary weapon delivery mode. STBY mode requires power from the DC armament bus and becomes active 6 seconds after selection. See figure 1-68 or 1-69, as applicable.
DEPR knob	-	Enables the primary and standby aiming reticles to be manually depressed over a range of +10 to -300 mil referenced to the ADL.
Function selector switch [62]	NITE	Energizes a motor-driven roller mechanism which draws a red plastic film across the lens of the projection unit which serves as a filter during night operations.
	DAY	Energizes a motor-driven roller mechanism which withdraws the red plastic film from across the lens of the projection unit for day operations.
	Km	Depressing the knob once displays the distance to go in kilometers. Depressing again returns the distance to go display to nm.

Figure 1-67. (Sheet 3 of 4)

T.O. 1A-10A-1

<u>Control or Indicator</u>	<u>Position or Display</u>	<u>Function</u>
Function selector switch [62] (Cont)	TAPE	Depressing the knob once displays a tape of calibrated airspeed and altitude. Depressing again returns airspeed and altitude displays to numerics.
	OPT	Provides two optional symbol sets, A and B, which add or subtract symbols. Depressing the knob once selects option A, depressing twice selects option B, and depressing again, returns display to normal.
	RDR ALT	Not functional.
BARO knob (push to turn) [24]	Adjustable	Altitude is displayed on a moving scale as read against a fixed index on the right side of the display. This control allows the altitude scale to be adjusted for correspondence with the pressure corrected altimeter reading. Its correction range is from -2,000 feet (full CCW) to +1,000 feet (full CW).
NIGHT/DAY FLTR switch [51]	NIGHT	Energizes a motor-driven roller mechanism which draws a red plastic film across the lens of the projection unit which serves as a filter during night operations.
	DAY	Energizes a motor-driven roller mechanism which withdraws the red plastic film from across the lens of the projection unit for day operations.
INTEN knob	Adjustable	Permits continuous control of brightness, from off at night to maximum during daylight for both primary and standby symbology. Full CW is maximum intensity, full CCW extinguishes all symbology.
MALF warning light pushbutton switch	On	Indicates malfunction when any HUD module fails. When pressed, the light will go off. If the light remains off, the malfunction is resolved. If the failure persists, the MALF light will again come on.

Figure 1-67. (Sheet 4 of 4)

HUD SYSTEM DISPLAYS 61

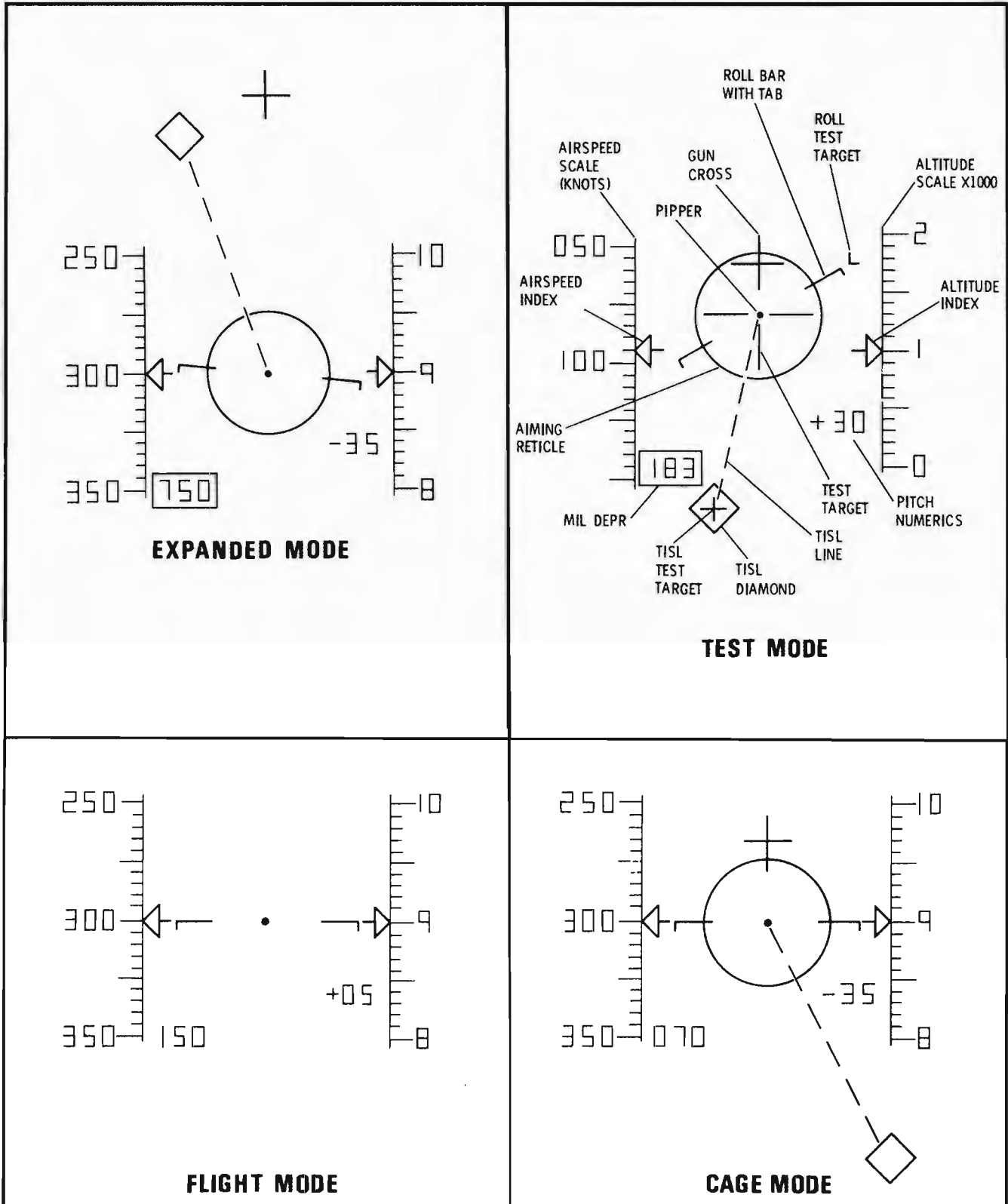

A1-10A-1-17

Figure 1-68. (Sheet 1 of 2)

HUD SYSTEM DISPLAYS 61 (CONT)

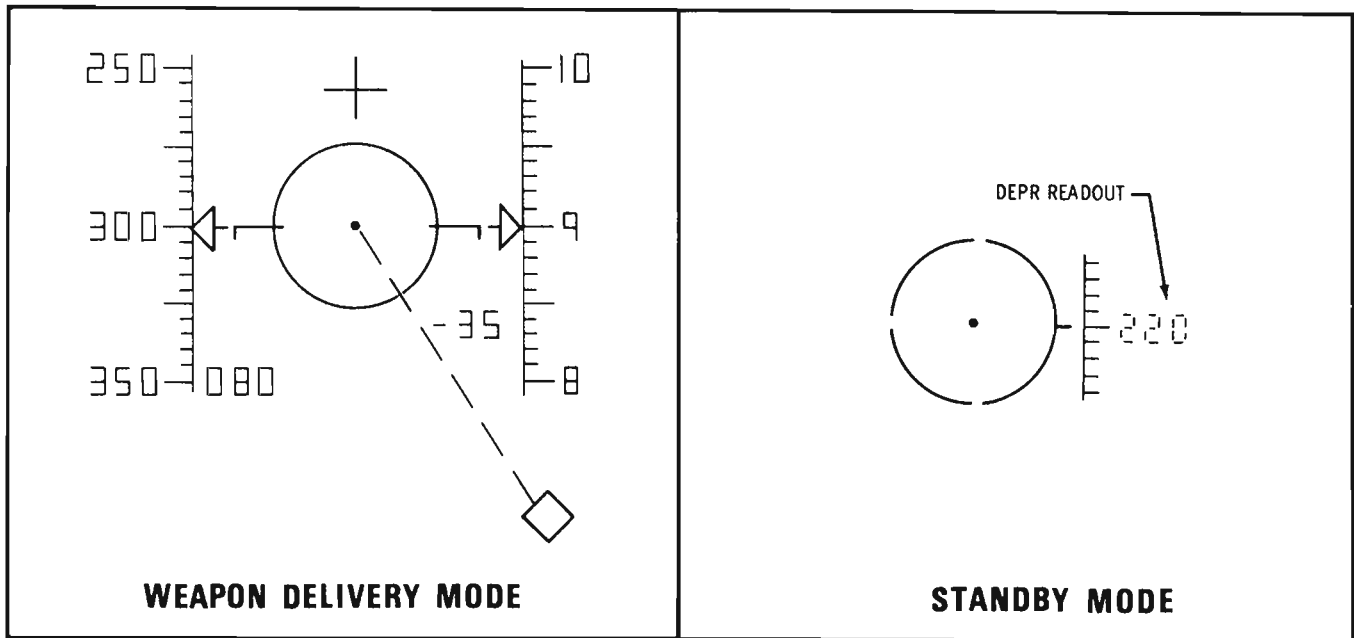

NOTE

- WEAPON DELIVERY, CAGE AND EXPANDED MODES ILLUSTRATED WITH TISL LOCKON.

A1-10A-1-67

Figure 1-68. (Sheet 2 of 2)

Altitude Tape

An altitude tape (figure 1-68) is a moving scale with a fixed index. The operational range is -2,000 to 38,000 feet. The moving portion of this display represents a total of 2,000 feet full scale with increment marks at each 100-foot interval, and elongated marks at each 500-foot interval. The numbers alongside the scale indicate altitude in 1,000-foot increments.

Pitch Angle

A two-digit numerical readout of aircraft pitch angle from +90° to -90° (figure 1-68) is provided. This readout feeds from the HARS system and does not consider AOA. When HARS senses inaccurate roll or pitch attitude data, the roll or pitch attitude displays are removed from the HUD.

Roll Attitude

Roll attitude data are received from HARS. The roll tabs (figure 1-68) operate over a range from 0° (wings level) to ±180°. An additional tab or index

at the end of each roll bar is provided to alert the pilot to an inverted flight situation, and to always indicate the ground direction. When HARS senses inaccurate roll or pitch attitude data, the roll and pitch attitude displays are removed from the HUD.

TISL Diamond and Line

The TISL diamond (figure 1-68) is 10 mil on a side and can move over the entire HUD field of view. If the position commanded by the laser spot seeker exceeds the total viewing field, the diamond is stowed at the edge of the viewing field to indicate relative direction of the laser illuminated ground target.

On 103, when AIM-9 Mode switch is in SEL, TISL diamond indicates missile seekerhead pointing direction. If the seekerhead exceeds the HUD field of view (FOV), the TISL diamond will blink indicating the FOV limit has been reached and the pointing direction is now relative.

HUD SYSTEM DISPLAYS 62

SYMBOL	MODE				
	NAV	W/D1	W/D2	EXP	TEST
	NORMAL OPTION A OPTION B HARS (1)	NORMAL OPTION A OPTION B HARS (1)	NORMAL OPTION A OPTION B HARS (1)	NORMAL OPTION A OPTION B HARS (1)	NORMAL OPTION A OPTION B HARS (1)
PIPPER	X X X X	X X X X	X X X X	X X X X	X X X X
AIMING RETICLE		X X X X	X X X X	X X X X	X X X
(2) RETICLE EYEBROWS			X X X X	X X X X	X X X
(3) GUN CROSS		X X X X	X X X X	X X X X	X X X
AIR SPEED NUMERIC/TAPE (OPTION)	X X X X	X X X X	X X X X	X X X X	X X X X
ALTITUDE NUMERIC/TAPE (OPTION)	X X X X	X X X X	X X X X	X X X X	X X X X
DEPRESSION NUMERIC	X X X X	X X X X	X X X X	X X X X	X X X X
STEER POINT NUMERIC	X X X	X X X	X X X	X X X	X X X
TIME TO GO	X X	X X	X	X	X X
DISTANCE TO GO	X X	X X	X	X	X X
NM/KILOMETER (OPTION)	X X	X X	X	X	X X
FLIGHT PATH LADDER	X X X	X X X	X X X	X X X	X X
TVV	X X X	X	X X X	X X X	X X X
DEST INDEX (TADPOLE)	X X	X	X X	X X	X X X
HEADING TAPE	X X X	X X	X	X	X X X
VERTICAL VELOCITY	X X				X X
FLT PATH ANGLE NUMERIC		X X			X X
PITCH NUMERIC (BOXED)				X	X
ROLL BARS				X	X
(4) TISL DIAMOND & LINE	X X X X	X X X X	X X X X	X X X X	X X X X
PIPPER TARGET					X X X X
ROLL TARGET					X
TISL TARGET					X X X X

NOTE:

- (1) Only appears when INS is unreliable.
 - (2) Only appears at depression of 100 mil or more.
 - (3) Only appears at depression of 50 mil or more.
 - (4) Only appears with TISL lock-on for modes other than TEST or, when AIM-9 Mode switch is in SEL position.
- X Data displayed on HUD shall be boxed.

Figure 1-69. (Sheet 1 of 6)

HUD SYSTEM DISPLAYS [62] (CONT)

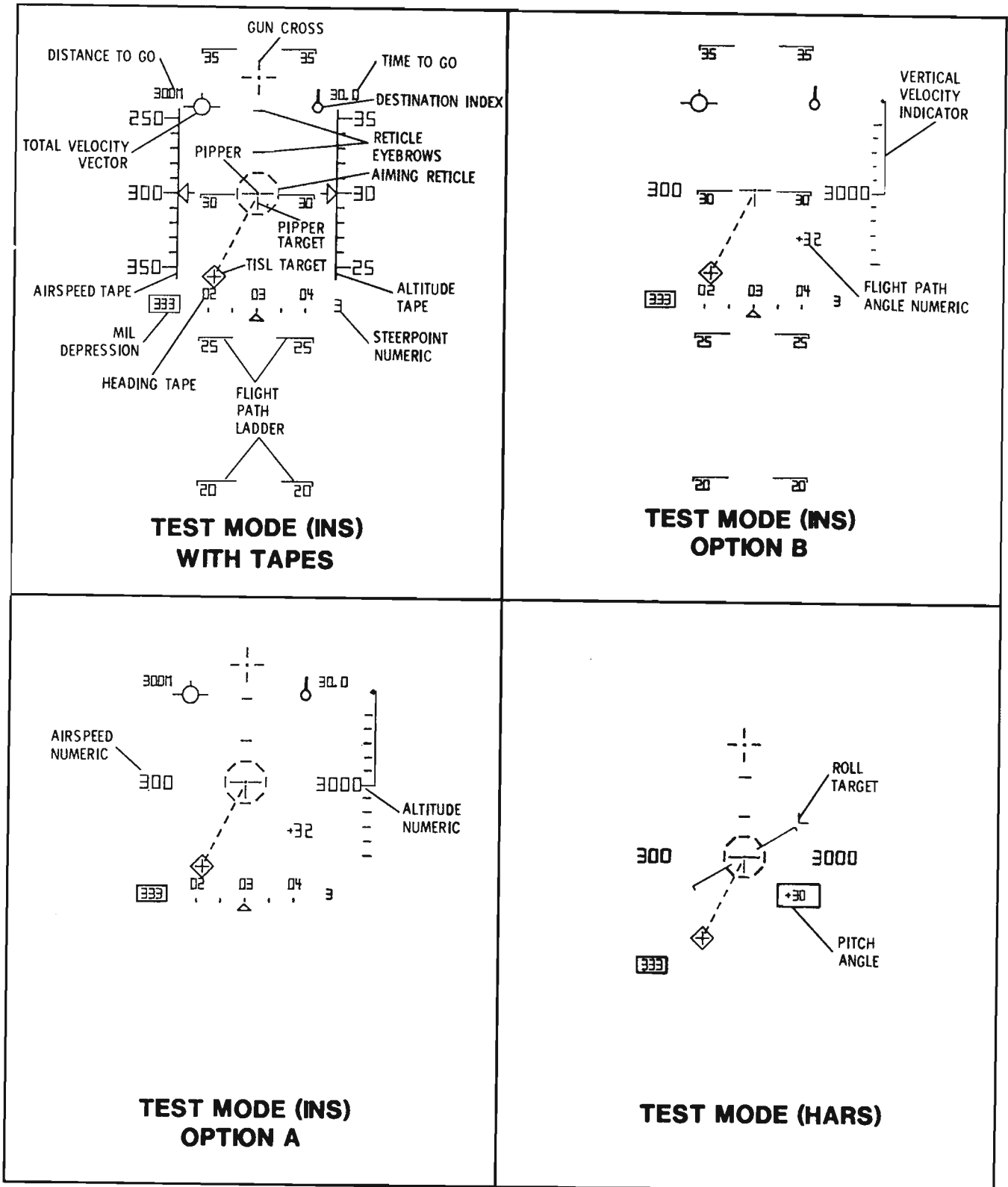
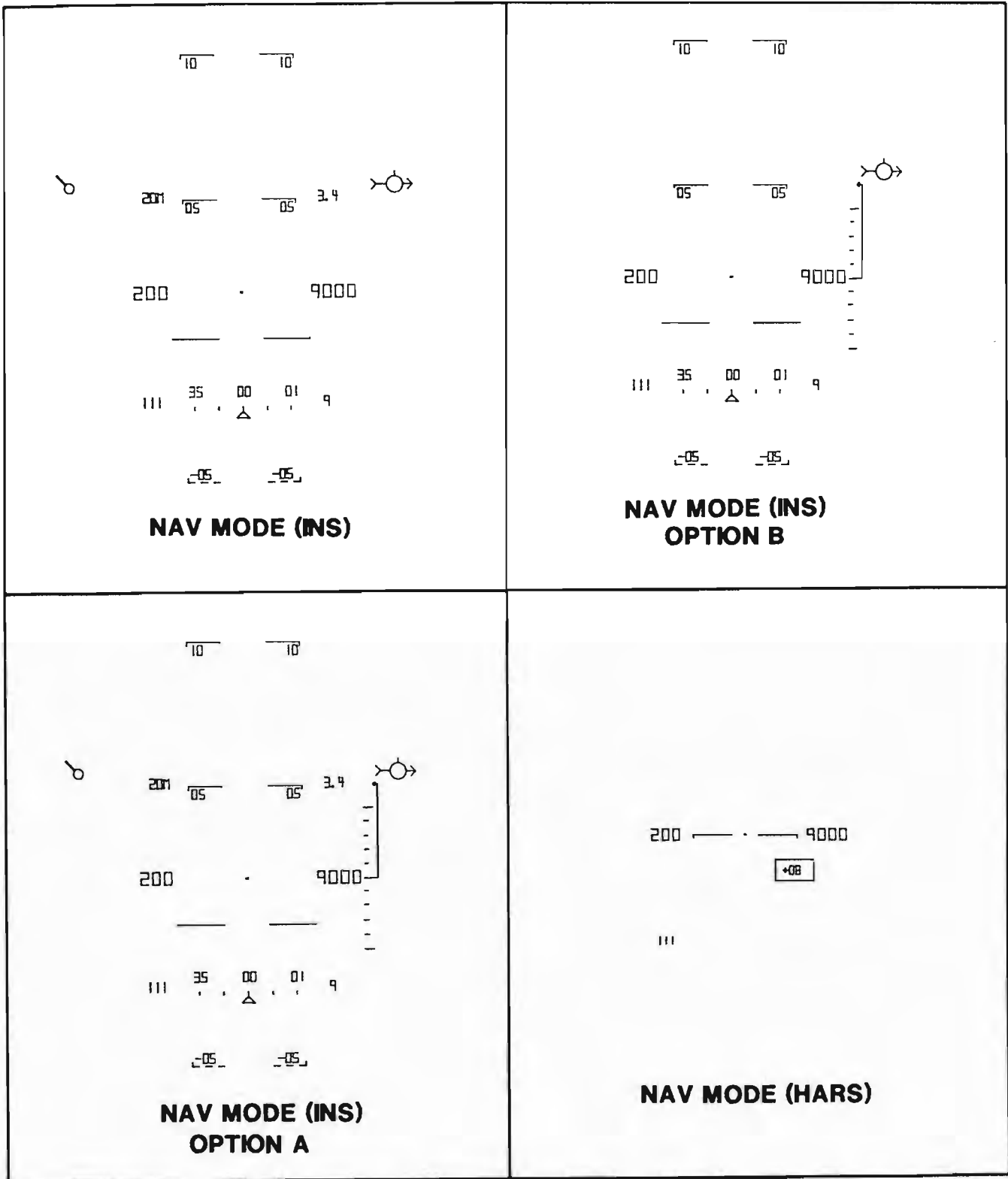

Figure 1-69. (Sheet 2 of 6)

HUD SYSTEM DISPLAYS 62 (CONT)



1-106-1-74

Figure 1-69. (Sheet 3 of 6)

HUD SYSTEM DISPLAYS 62 (CONT)

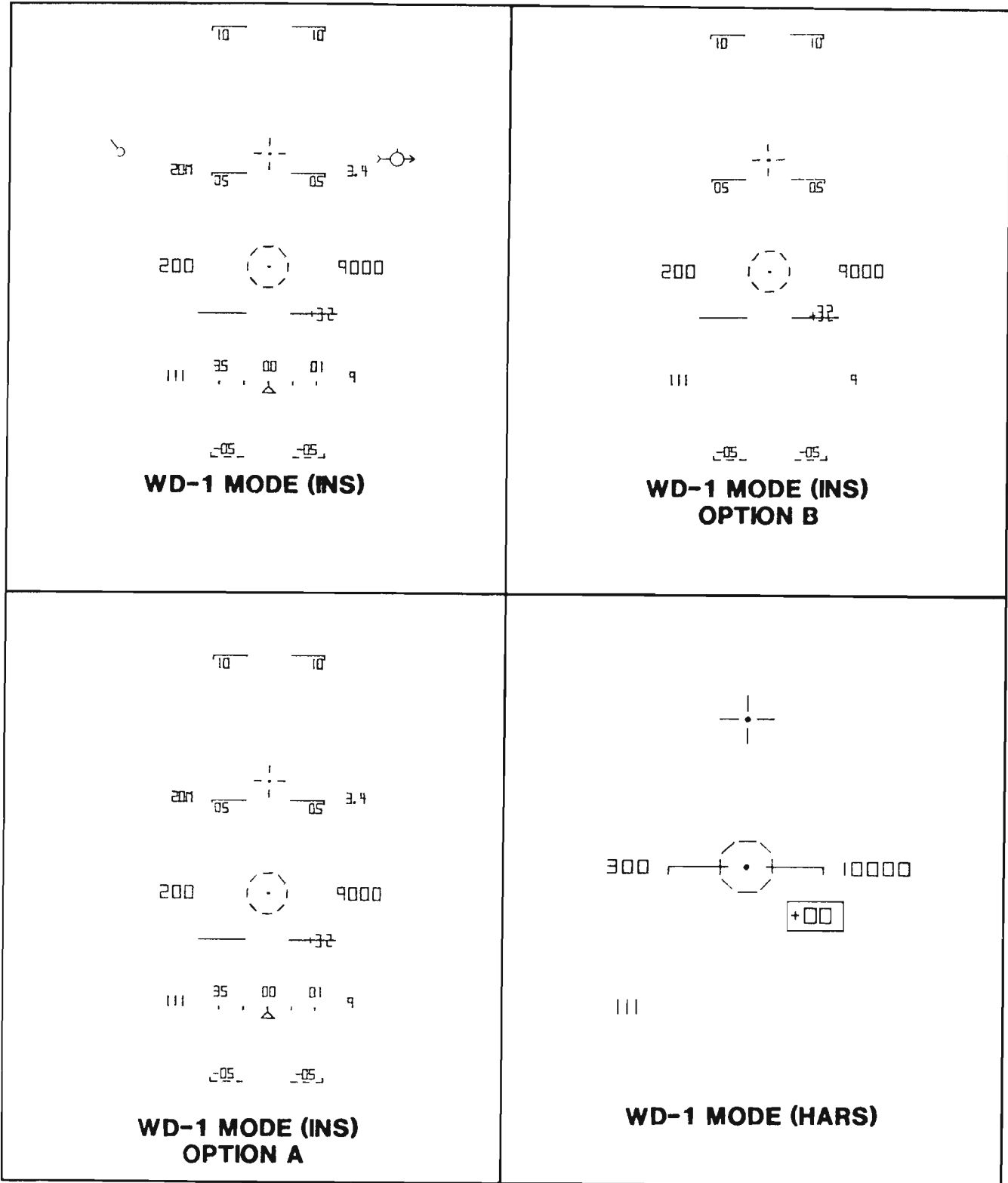

A1-10A-1-73

Figure 1-69. (Sheet 4 of 6)

HUD SYSTEM DISPLAYS 62 (CONT)

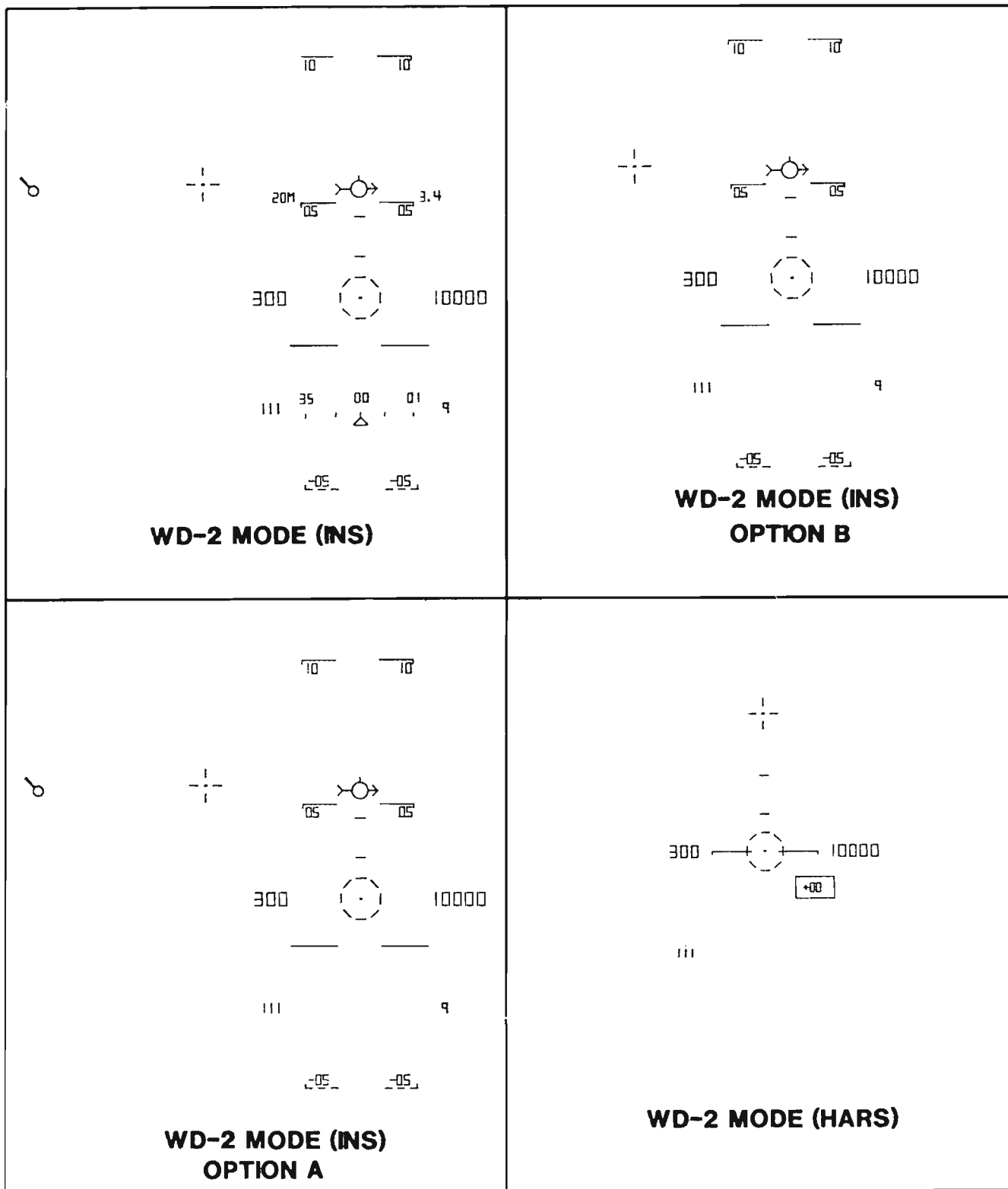
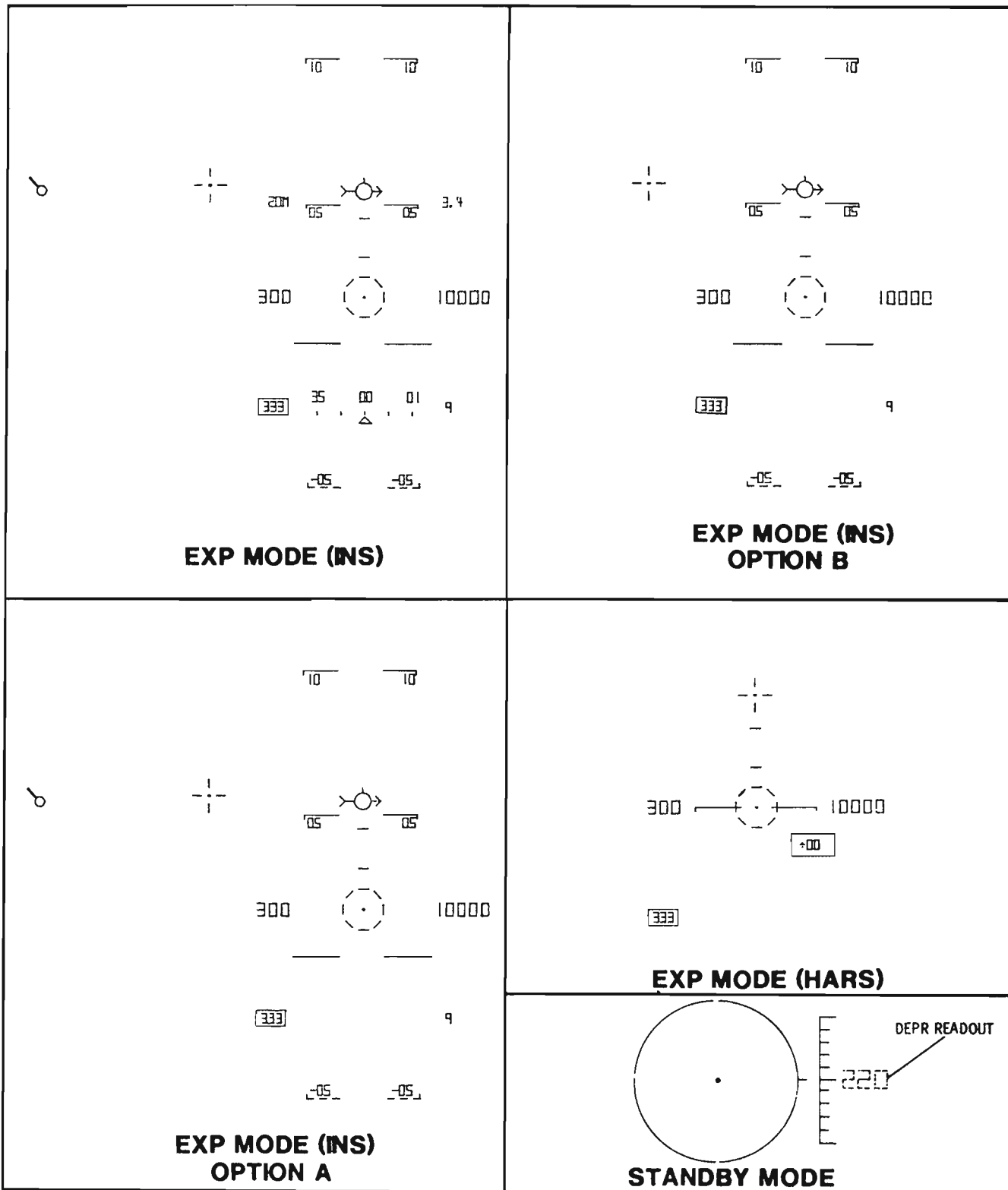

Figure 1-69. (Sheet 5 of 6)

A1-10A-1-74

HUD SYSTEM DISPLAYS 62 (CONT)



1-10A-1-75

Figure 1-69. (Sheet 6 of 6)

A discrete signal from the laser spot seeker enables the diamond to indicate that a firm lock-on has been achieved. A dashed line connects the TISL diamond to the aiming pipper to facilitate target azimuth alignment and tracking. On [50], the dashed line is inhibited within a rectangular area around the aiming reticle. On [53], the dashed line will disappear when the length decreases to approximately 13 mil.

HUD DISPLAY SYMBOLOGY [62]

The HUD provides a variety of symbols and numerics in the TEST, NAV (navigation), and WD-1 and WD-2 modes. Figure 1-69 provides a listing of each symbol and when it will be displayed, as determined by mode and option selected; and a display of the HUD modes, for both INS and HARS. In all CRT modes of operation, all display symbology, except the TVV, destination index, gun cross, TISL diamond, and a portion of its associated line are depressed with the aiming reticle. Altitude data from the altitude computer and pitch and roll data from the INS or HARS are removed from the HUD display when their respective systems sense inaccurate data.

Aiming Reticle and Pipper

The aiming reticle is a 25 mil diameter octagon with a 2 mil dot. The aiming reticle contains eight equally spaced lines. The pipper is positioned from +10 to -300 mil in the vertical plane of the HUD display by the depression control on the HUD control unit.

Gun Cross

The gun cross symbol consists of two vertical arms and two horizontal arms located symmetrically around a 1 mil diameter dot. The gun cross is fixed 41 mil below the ADL and horizontally centered.

Standby Reticle

The standby reticle is a separately generated, manually depressible 50 mil diameter aiming reticle ring and pipper, positioned within 3 mil of the primary weapon delivery mode. A depression scale readout is displayed adjacent to the aiming reticle.

Airspeed and Altitude Readouts

Airspeed is presented from 50 - 500 knots. Altitude is presented from -2,000 to 38,000 feet. The airspeed and altitude readouts will flash when a master caution signal is received.

Airspeed Tape

The optional airspeed tape, when selected, provides a moving scale and fixed index of CAS. The operational range is from 50 - 500 KCAS. The moving portion of the display represents a total of 100 knots full scale, with increment marks at 10-knot intervals and elongated marks, with numerics in knots, at 50-knot intervals. The airspeed tape flashes when a master caution signal is received.

NOTE

- On [62], the HUD altitude and airspeed tapes may intermittently flash without the MASTER CAUTION light flashing. This does not indicate a failure.

Altitude Tape

The optional altitude tape, when selected, provides a moving scale and fixed index of barometric corrected altitude. The operational range is from -2,000 to 38,000 feet. The moving portion of the display represents a total of 1,000 feet full scale, with increment marks at 100-foot intervals and elongated marks, with numerics in hundreds of feet, at 500-foot intervals. The altitude tape flashes when a master caution signal is received.

Flight Path/Pitch Angle Numeric

In INS, provides aircraft flight path angle from -90 to +90°. In HARS backup mode, the numeric indicates pitch angle and is boxed in a rectangle.

Flight Path Ladder and Roll Bars

The flight path ladder consists of four ladder lines, separated by 5°, and labeled in degrees of elevation at each end. Range of the angles is from +90 to -90°. Tabs on the ladder lines point toward the horizon line. Negative elevation lines are dashed, while positive elevation lines are solid on each side of the center gap. Roll is indicated over a range from 0° - 360°, rotating around the 41 mil depression position in NAV and WD-1 modes, and around the TVV symbol in the WD-2 and EXP modes.

TISL Diamond and Line

The TISL diamond symbol is enabled when a TISL lock-on (track) is achieved or on [103] when the

AIM-9 mode switch is in the SEL position for air-to-air attack (missile). If the TISL diamond is greater than 13.5 mil from the pipper, an equally spaced dashed line, consisting of 6 equal dashes, appears and connects the TISL diamond to the pipper. The TISL diamond is positionable anywhere within a 314 mil diameter circle around the display center. On **103**, when loaded with boresight missiles and the AIM-9 MODE switch is in the SELECT position, the TISL diamond will be centered on the HUD to indicate the missile seekerhead's caged boresight position. If missile seekerhead is uncaged, the TISL diamond will be off indicating missile seekerhead position is unknown. When loaded with missiles having slaveable seekerheads and AIM-9 MODE SWITCH is in SELECT position, TISL diamond on HUD indicates direction AIM-9 missile's seekerhead is pointing. If the seekerhead's look angle exceeds HUD limit, TISL diamond will blink and be at full scale deflection in direction missile seekerhead is pointed.

Depression Angle Numeric

The depression angle numeric represents the pipper position, in mil, in the HUD vertical plane below the ADL. When the depression angle is greater than zero, it is displayed as 2 digits preceded by a plus sign. In EXP and TEST modes, the angle numeric is multiplied by 3 and boxed by a solid rectangle.

Reticle Eyebrows

The reticle eyebrows are short horizontal lines centered about the pipper at 25 and 50 mil. The eyebrows appear only when the aiming reticle is depressed 100 mil or more.

Vertical Velocity Indicator

The vertical velocity indicator displays aircraft vertical velocity in feet per minute. The indicator consists of an unlabeled vertical scale containing three major increment marks and eight minor increment marks. The scale pointer is joined to the zero mark. Range of the scale represents 0 to $\pm 1,000$ feet per minute and each interval represents 200 feet per minute vertical velocity.

Magnetic Heading Tape

The magnetic heading tape provides a moving scale and fixed pointer indication of magnetic heading over the range from 0 - 360°. Marks representing

multiples of 10° have two digit numerics above them (01 representing 10°). Marks representing 5° have no numerics.

Steerpoint Alphanumeric Readout

The steerpoint alphanumeric readout is displayed as 0 - 9, for waypoints, or A - F, for mark positions, depending on the selected steerpoint. The mark alpha readout will flash when a mark function is initiated.

Time To Go

The time to go readout displays the time remaining over the steerpoint, in minutes and tenths of minutes.

Distance To Go

The distance to go readout displays the distance remaining over the steerpoint, in miles and tenths of miles. Depressing Km on the function switch provides the readout in kilometers.

Total Velocity Vector

The TVV symbol is a circle with 3 lines extending from the perimeter, and indicates the direction of aircraft velocity. The TVV position is limited to $\pm 9^\circ$ vertically and $\pm 5.5^\circ$ horizontally, relative to display center. When horizontally limited, arrowheads appear on the horizontal lines of the TVV and point toward the computed TVV position. The TVV displays where the aircraft is going, both laterally and vertically.

Destination Index (Tadpole)

The destination index symbol is a circle with a strobe extending from the perimeter. The strobe position represents relative bearing, from 0° - 360°, to the selected steerpoint. The position of the tadpole itself represents relative bearing of the selected steerpoint, when the bearing is within the HUD field of view. Horizontal movement of the tadpole is limited to $\pm 5.0^\circ$ if computed TVV vector is in excess of the true steerpoint relative bearing and $\pm 6.0^\circ$ if computed TVV vector is less than the true steerpoint relative bearing. The tadpole is slaved to the TVV in elevation, and roll stabilized about the TVV.

Roll Bars (HARS Only)

The roll attitude display for the HARS backup mode consists of roll bars centered on the pipper. Each end of the roll bar has a tab pointing down, to alert the pilot of inverted flight. The roll bars move in elevation with the pipper and rotate about the pipper. Operational range for the roll bars is 0 (wings level) to $\pm 180^\circ$.

HUD SYSTEM OPERATION

On [61], the HUD system is capable of operating in the following modes: TEST, FLT, W/D, CAGE, EXP, and STBY (see figure 1-68). On [62], the

operating modes are TEST, NAV, WD-1, WD-2, EXP, and STBY (see figure 1-69).

Test Mode

The test mode provides a visual self-test feature within the equipment that exercises all units to the extent necessary for fault isolation, and is operable in flight. In flight, the test display provides the pilot with a high confidence factor concerning correct HUD operation.

On **[61]**, in the test mode:

- Pitch attitude $+30^\circ \pm 2^\circ$
- The right and left roll bar segments are in line with one another and the right segment is aligned with any portion of the roll test target
- The airspeed tape and fixed index are aligned at $92.5(\pm 2.5)$ knots (each scale division is 5 knots)
- The altitude tape and fixed index are aligned at $1,000(\pm 50)$ feet (each scale division is 100 feet)
- Depression angle readout is $183(\pm 7)$ mil and boxed
- The aiming reticle is centered about the aiming pippier, and the reticle ring is round and smooth with no noticeable discontinuities
- The gun cross is related to the 50 mil reticle ring positioned at 41 mil
- The TISL test target is approximately centered within the TISL diamond
- The center of the aiming reticle is connected to the center of the TISL diamond by 6 equally spaced line segments.

On **[62]**, in the test mode:

- Airspeed numeric readout will be $300(\pm 1)$ knots. If tape option is selected, airspeed tape and fixed index are aligned at $300(\pm 2.5)$ knots (each scale division is 10 knots)
- Altitude numeric readout will be $3,000(\pm 10)$ feet. If tape option is selected, altitude tape and fixed index are aligned at $3,000(\pm 25)$ feet (each scale division is 100 feet)
- Depression angle readout will be $333(\pm 7)$ mil and boxed

- The aiming reticle is centered about the aiming pippier and is made up of 8 separate lines, shaped as an octagon
- The gun cross will be centered in azimuth and between the upper eyebrow and the 35° pitch ladder segment (at -41 mil)
- The TISL test target is approximately centered within the TISL diamond
- The center of the aiming reticle will be connected to the center of the TISL diamond by 6 equally spaced line segments
- The flight path ladder will be shown in 4 incremental readouts from 20 – 35. The left and right flight path ladder segments will be aligned with one another and the end tabs pointing to bottom of display
- The destination index will be positioned at the upper right side of the display, to the lower left of the time to go readout
- The time to go readout will be 30.0 minutes
- The steerpoint readout will be 3
- The magnetic heading tape will show a range of 20 and the heading tape and fixed index are aligned at $030(\pm 1)^\circ$
- The TVV symbol will be positioned at the upper left side of the display, to the lower right of the distance to go readout
- The distance to go readout will be 300M
- The aiming reticle eyebrows will be centered above the pippier at an estimated 25 and 50 mil.

NOTE

- Optional symbology may be selected while in the TEST mode, by setting the option select switch to TAPE and depressing. Symbology shall read as follows:

CAS tape	—	$300(\pm 2.5)$ knots
Altitude tape	—	$3,000(\pm 25)$ feet
Flight path angle numeric	—	$33(\pm 1)^\circ$
Vertical velocity indicator	—	$+1,000(\pm 50)$ feet per minute

GUNSIGHT CAMERA SYSTEM 68 99

The KB-26A gun camera system is comprised of the camera, a periscope, and inflight-replaceable film magazines. The camera system is installed in a recessed area above and forward of the instrument panel (52, figure FO-1). 10 aircraft have a KB-26C gun camera system installed in place of the KB-26A gun camera system. The systems are identical except that a low profile 30mm lens replaces the periscope type 50mm lens on the KB-26A gun camera system. For further information, refer to T.O. 1A-10A-34-1-1.

COCKPIT TELEVISION SENSOR/ AIRBORNE VIDEO TAPE RECORDER SYSTEM 69 98

The CTVS/AVTR system provides a video tape recording of a real world scene with the HUD symbology superimposed upon it or TV monitor video, as well as pilot's associated headset audio. The CTVS/AVTR system consists of the CTVS, AVTR, and the CTVS/AVTR control panel (figure 1-70). The CTVS/AVTR control panel contains the controls and indicators necessary to operate and monitor the CTVS and AVTR. The tape cassette is loaded at access F139 (figure 1-71). The CTVS/AVTR system is powered by the AC and DC armament busses. For further information, refer to T.O. 1A-10A-34-1-1.

TV MONITOR SYSTEM

The TV monitor system is composed of a TV display unit (29, figure FO-1) and a TVM control unit (9, figure FO-2).

The TVM displays a TV picture of the video signal originating in a television sensor located in the AGM-65 Maverick missile, or in the GBU-8/B bomb. For further information, refer to T.O. 1A-10A-34-1-1.

TARGET IDENTIFICATION SET LASER

The TISL (figure 1-66), is a forward-looking laser seeker and tracker system. The system consists of a laser-illuminated detector, an ACD, and a control panel. The detector is attached to the lower right fuselage on an adapter pylon. The ACD connects the pod with the aircraft systems. The TISL control panel is mounted on the instrument pedestal. The

TISL system functions are to search for coded laser energy reflected from a target being illuminated by a coded laser designator, to lock on and track, and to provide target location information to the aircraft avionics systems. Target location information is presented on the HUD and the ADI to aid the pilot during ordnance delivery. The TISL is powered by the AC and DC armament busses. For further information, refer to T.O. 1A-10A-34-1-1.

CHAFF/FLARE DISPENSING SYSTEM 45

The AN/ALE-40(V) chaff/flare dispensing system provides the means of deploying expendable chaff and flare payloads as a countermeasure against radar and infrared controlled threats, respectively. The system is powered by the auxiliary DC essential bus.

Four chaff/flare dispensers are installed in each main landing gear pod and each wing tip. The dispenser release sequence is illustrated in figure 5-5. For further information on the AN/ALE-40(V) chaff/flare dispensing system, refer to T.O. 1A-10A-34-1-1.

WARNING

- Do not arm the ALE-40 chaff/flare system for release until mission requirements dictate. With the system armed, inadvertent releases are possible when moving the engine/APU fire handles, instrument inverter switch, or master exterior light/missile video polarity switch. In addition, the program release sequence will stop when the signal lights switch (BRT/DIM) is moved. Electromagnetic interference (EMI) may also be present when operating other unidentified cockpit switches.

ELECTRONIC COUNTERMEASURE SYSTEM

The ECM system detects the presence of radar signals and warns the pilot that the aircraft is being illuminated by radar energy. The system is also capable of detecting and degrading radar reception by transmitting jamming signals. The ECM system consists of the radar warning system, ECM control panel, and ECM pods. ECM pods provide detection and jamming of radar signals and can be mounted on pylon stations 1 and 11. The pods are controlled by the ECM control panel (6, figure FO-5).

COCKPIT TELEVISION SENSOR/AIRBORNE VIDEO TAPE RECORDER CONTROL PANEL 69 98

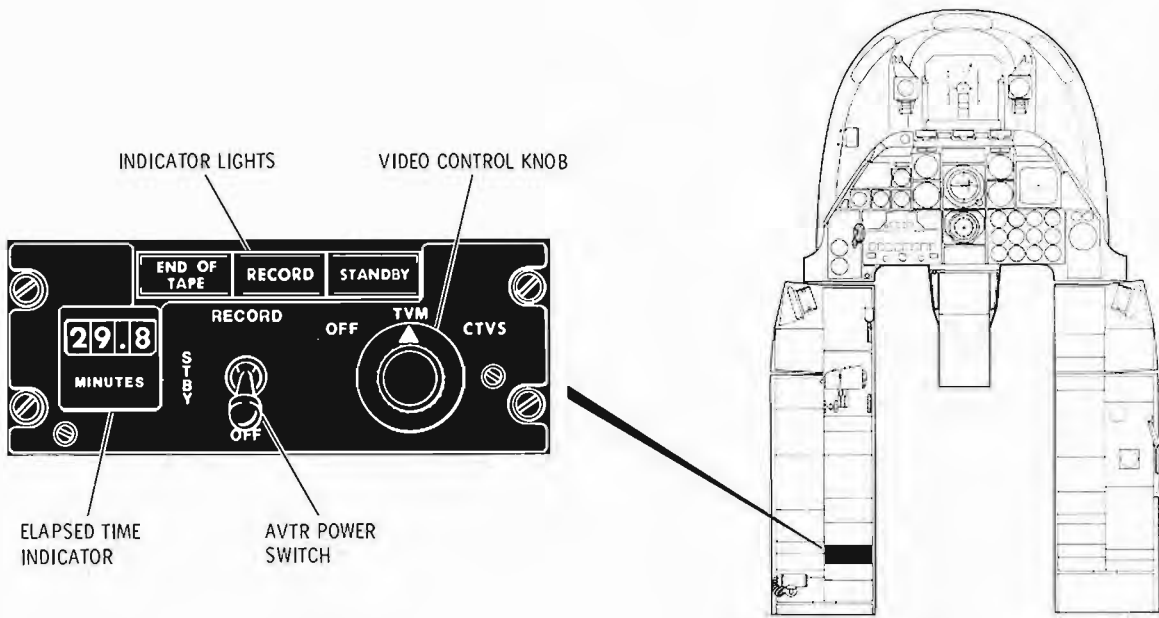

1-10A-1-92

<u>Control or Indicator</u>	<u>Condition or Position</u>	<u>Function</u>
Elapsed time indicator	On	Indicates the accumulated AVTR recording time in minutes and tenths of minutes. When the AVTR power switch is set to OFF, the display will go off and reset to zero.
END OF TAPE light	On (yellow)	Indicates the AVTR tape has been recorded and the end-of-tape sensor has been detected (approximately 30 minutes recording time).
RECORD light	On (green)	Indicates the AVTR is in the RECORD mode.
STDBY light	On (green)	Indicates the AVTR is in the STBY mode.

Figure 1-70. (Sheet 1 of 2)

T.O. 1A-10A-1

<u>Control or Indicator</u>	<u>Condition or Position</u>	<u>Function</u>
AVTR power switch	OFF	Removes AC power from the CTVS immediately, and DC power from the AVTR after a 10-second delay to allow the tape to unthread. Also, it shuts off the display of the elapsed time indicator while resetting the digital display to zero.
	NOTE	
	<ul style="list-style-type: none">• Cassette cannot be removed without damaging tape, unless unthreading is completed.	
Video control knob	STBY	Activates the CTVS and sets the AVTR to a standby condition awaiting activation by the gun trigger switch or weapons release button. STBY can also be used in the TVM mode, when RECORD is not required.
	RECORD	Activates the CTVS and enables the AVTR to record either CTVS or TVM video, independent of the gun trigger switch or weapons release button.
	OFF	Prevents video from either the TV monitor or CTVS from being recorded by the AVTR.
Video control knob	TVM	Enables video on the TV monitor to be recorded by the AVTR.
	CTVS	Enables video on the CTVS to be recorded by the AVTR.

Figure 1-70. (Sheet 2 of 2)

RADAR WARNING SYSTEMS

A radar warning system may be installed in the aircraft. The system detects the presence of radar signals and provides visual and aural indications.

This information is displayed on the azimuth indicator (21, figure FO-1) and control indicator (17, figure FO-1) located on the main instrument panel. For further information on the radar warning systems, refer to T.O. 1A-10A-34-1-1.

SERVICING DIAGRAM

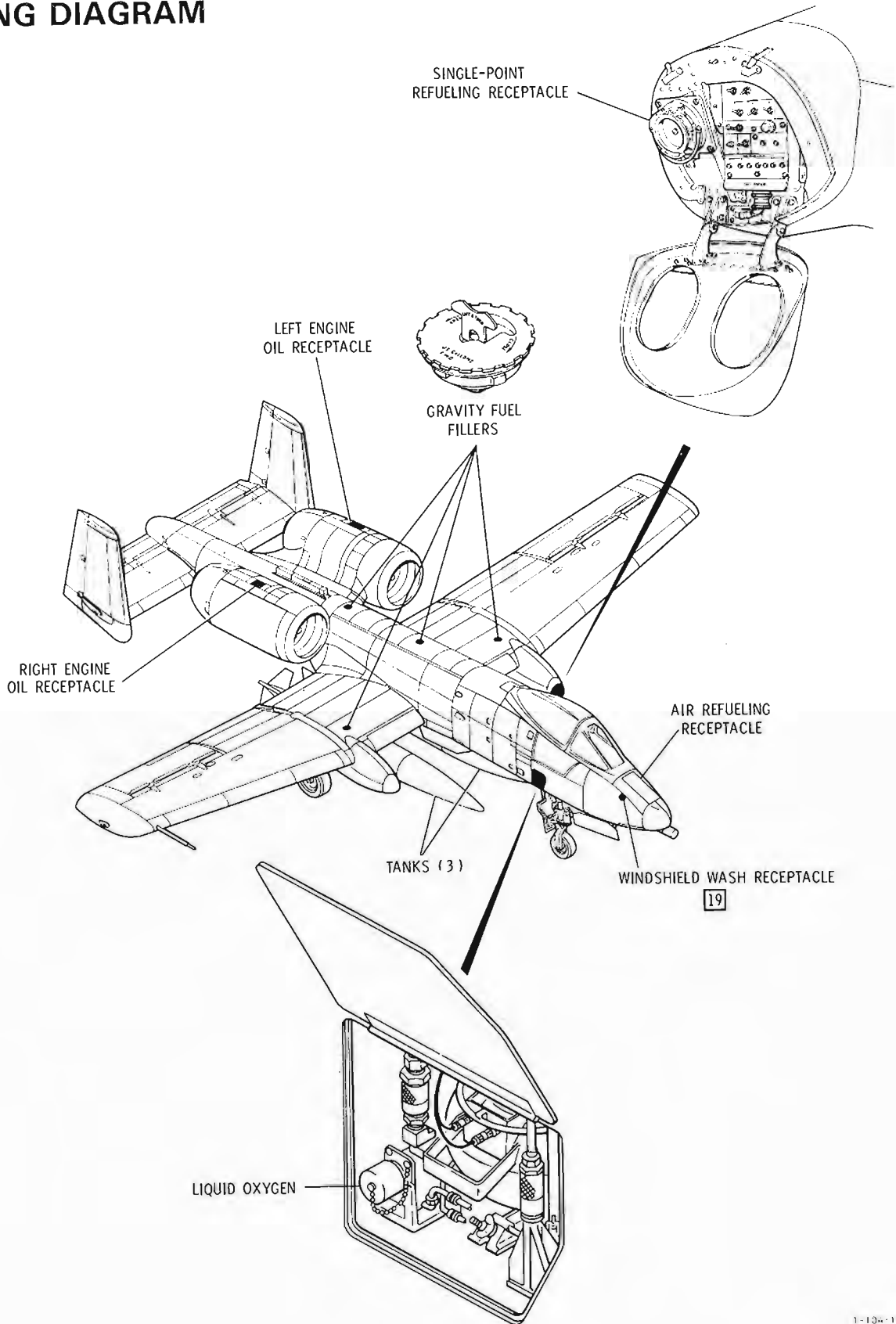

1-10A-1 65

Figure 1-71. (Sheet 1 of 4)

SERVICING DIAGRAM (CONT)

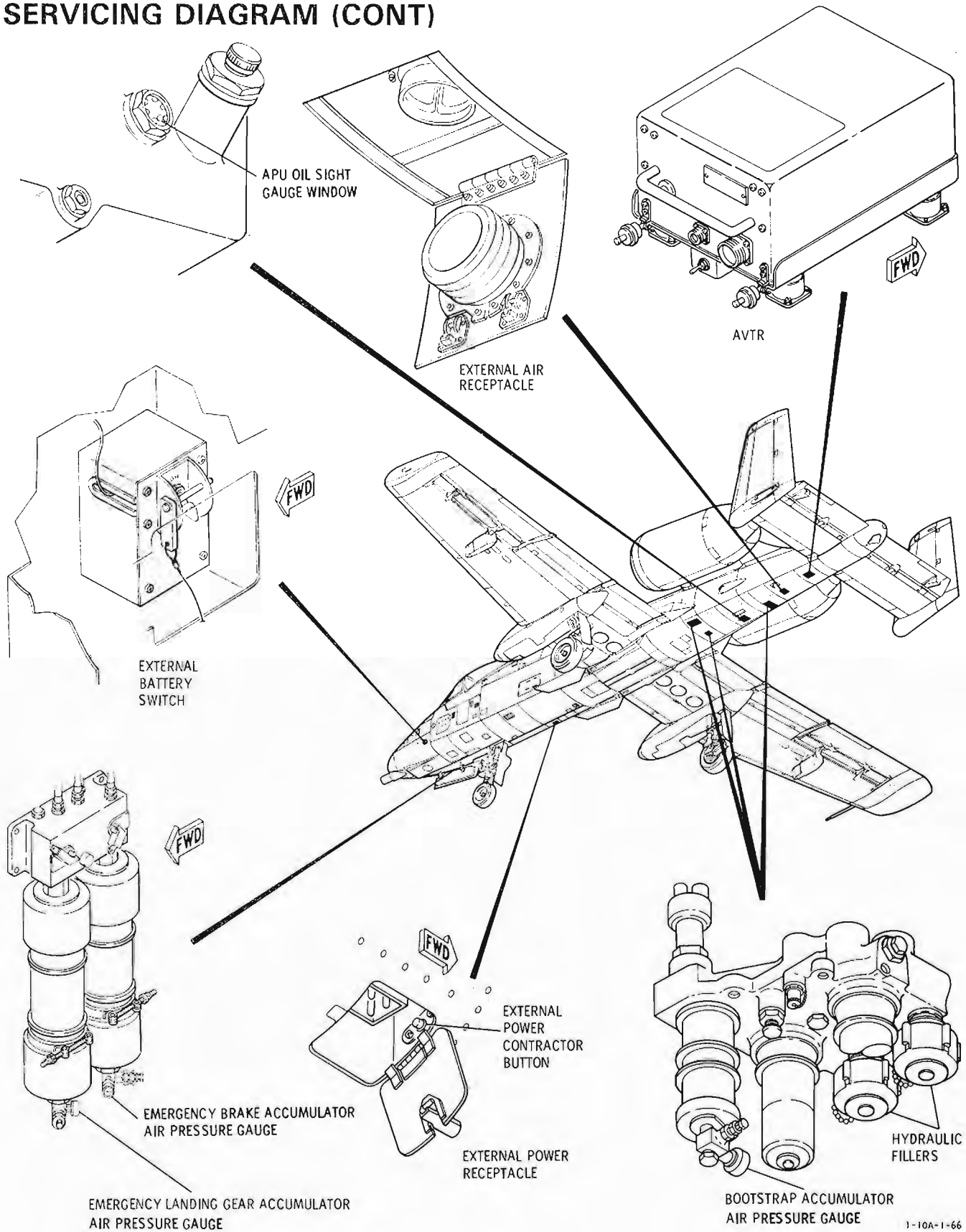

Figure 1-71. (Sheet 2 of 4)

SERVICING DIAGRAM (CONT)

NOTES:

1. IF POSSIBLE, THE AIRCRAFT SHOULD BE REFUELED IMMEDIATELY AFTER FLIGHT, TO MINIMIZE WATER CONDENSATION IN THE FUEL TANKS.
2. JP-4, JP-5, AND JP-8 MAY BE COMBINED TO FORM A MIXTURE. THE MIXTURE MAY CONTAIN ANY QUANTITY OF THESE FUELS; HOWEVER, TEMPERATURE LIMITS FOR JP-5 OR JP-8 SHALL BE OBSERVED. IF THESE FUELS ARE USED IN THE MIXTURE, ENGINE OPERATIONS ARE RESTRICTED TO THE FOLLOWING TEMPERATURE RANGES (REF T.O. 2J-TF34-116-1):

JP-4, JET B, NATO F-40:	- 54 DEGREES C {-65 DEGREES F} TO 57 DEGREES C {135 DEGREES F}
JP-5, JET A/A-1, NATO F-44:	- 29 DEGREES C {-20 DEGREES F} TO 57 DEGREES C {135 DEGREES F}
JP-8, NATO F-34:	- 29 DEGREES C {-20 DEGREES F} TO 57 DEGREES C {135 DEGREES F}

3. a. WITH ICING AND CORROSION INHIBITORS — NO RESTRICTIONS.
- b. WITHOUT ICING INHIBITOR — ENSURE FUEL TEMPERATURE IS MAINTAINED ABOVE 0 DEGREES C (32 DEGREES F). EXPOSURE OF AN HOUR OR TWO TO LOW TEMPERATURE WILL NOT SIGNIFICANTLY CHANGE THE TEMPERATURE OF FUEL IN THE AIRCRAFT FUEL TANKS.
- c. WITHOUT CORROSION INHIBITOR — ENGINE OPERATIONS SHALL BE RESTRICTED TO 10 CONSECUTIVE HOURS.
4. a. ALL FUELS SHALL BE TREATED WITH AN APPROVED CONDUCTIVITY ADDITIVE TO OBTAIN A CONDUCTIVITY OF 100 — 700 CU (REF. T.O. 42B-1-1).
- b. ALL FUELS WITHOUT CONDUCTIVE ADDITIVE — FLIGHT LIMITED TO EMERGENCIES ONLY WITH MINIMUM MANEUVERING.

SERVICEABLE ITEM		USAF SYMBOL	MILITARY SPECIFICATION	NATO SYMBOL	COMMERCIAL DESIGNATION (NOTE 3)
FUEL (NOTES 1 AND 2)	PRIMARY	JP-4 (NOTE 4)	MIL-T-5624	F-40 (NOTE 4)	JET B (NOTE 4)
		JP-5 (NOTE 4)	MIL-T-5624	F-44 (NOTE 4)	JET A AND JET A-1 (NOTE 4)
		JP-8 (NOTE 4)	MIL-T-83133	F-34 (NOTE 4)	NONE
	ALTERNATE	JET A, A-1 AND JET B WITHOUT TWO ADDITIVES. OBSERVE NOTE 3 AND NOTE 4 RESTRICTIONS.			
	EMERGENCY	NONE AUTHORIZED			
ENGINE OIL			MIL-L-7808	0-148 0-149	
APU OIL			MIL-L-7808	0-148 0-149	
HYDRAULIC FLUID			MIL-H-83282		
OXYGEN			MIL-O-27210		

Figure 1-71. (Sheet 3 of 4)

SERVICING DIAGRAM (CONT)

WINDSHIELD WASH SOLUTION DISTILLED WATER/METHANOL (METHYL ALCOHOL) (40/60)		MIL-O-M-232F		
TIRE SERVICING (NITROGEN PN C-2666-5)	AIRCRAFT GROSS WT (LB)	MLG TIRE INFLATION PRESSURE (PSI)	NLG TIRE INFLATION PRESSURE (PSI)	
	ALL GROSS WTS	185(± 5)	140(± 5)	
BOOTSTRAP ACCUMULATORS (NITROGEN PN C-2666-5)		NITROGEN PRECHARGE (CLEAN-DRY) PRESSURE TOLERANCE ± 50 PSI		
		TEMP (°F)	PSI	
		-40 -20 0 20 40 60 70 80 100 120 130	1200 1280 1360 1430 1500 1570 1600 1640 1710 1800 1900	
EMERGENCY BRAKE AND EMERGENCY LANDING GEAR ACCUMULATORS (NITROGEN PN C-2666-5)		NITROGEN PRECHARGE (CLEAN-DRY) PRESSURE TOLERANCE ± 50 PSI		
		TEMP (°F)	PSI	
		-40 -20 0 20 40 60 70 80 100 120 140	900 950 1010 1065 1120 1175 1200 1230 1285 1340 1395	

Figure 1-71. (Sheet 4 of 4)

SECTION II

NORMAL PROCEDURES

TABLE OF CONTENTS

Preparation for Flight	2-1	Flight	2-14
Before Exterior Inspection	2-1	Descent/Before Landing	2-14
Exterior Inspection	2-1	Instrument Approaches	2-14
Before Entering Cockpit	2-3	Before Landing	2-18
Cockpit Interior Check	2-3	Landing	2-18
Prior to Engine Start	2-6	After Landing	2-21
Starting Engines	2-6	Engine Shutdown	2-22
Before Taxiing	2-9	Before Leaving the Airplane	2-22
Taxi	2-11	Alert/Cocking	2-23
Before Takeoff	2-13	Scramble (Before Taxiing)	2-23
Lineup Check	2-13	Scramble (Before Takeoff)	2-23
Takeoff	2-13	Hot Refueling	2-24
After Takeoff and Initial Climb	2-13	TEMS Status Check	2-25

PREPARATION FOR FLIGHT

FLIGHT RESTRICTIONS

Refer to Section V for all Operating Limitations.

FLIGHT PLANNING

Preflight planning data, such as takeoff performance, fuel required, cruise data, and other performance information to complete the proposed mission, will be determined using the performance data contained in T.O. 1A-10A-1-1.

WEIGHT AND BALANCE

Refer to Handbook of Weight and Balance Data, T.O. 1-1B-40 for the aircraft to be flown.

CHECKLIST

This section contains the amplified checklist. The abbreviated checklist is published separately as T.O. 1A-10A-1CL-1.

BEFORE EXTERIOR INSPECTION

1. AFTO Form 781 – Check.

EXTERIOR INSPECTION

Perform the exterior inspection as outlined in figure 2-1.

EXTERIOR INSPECTION

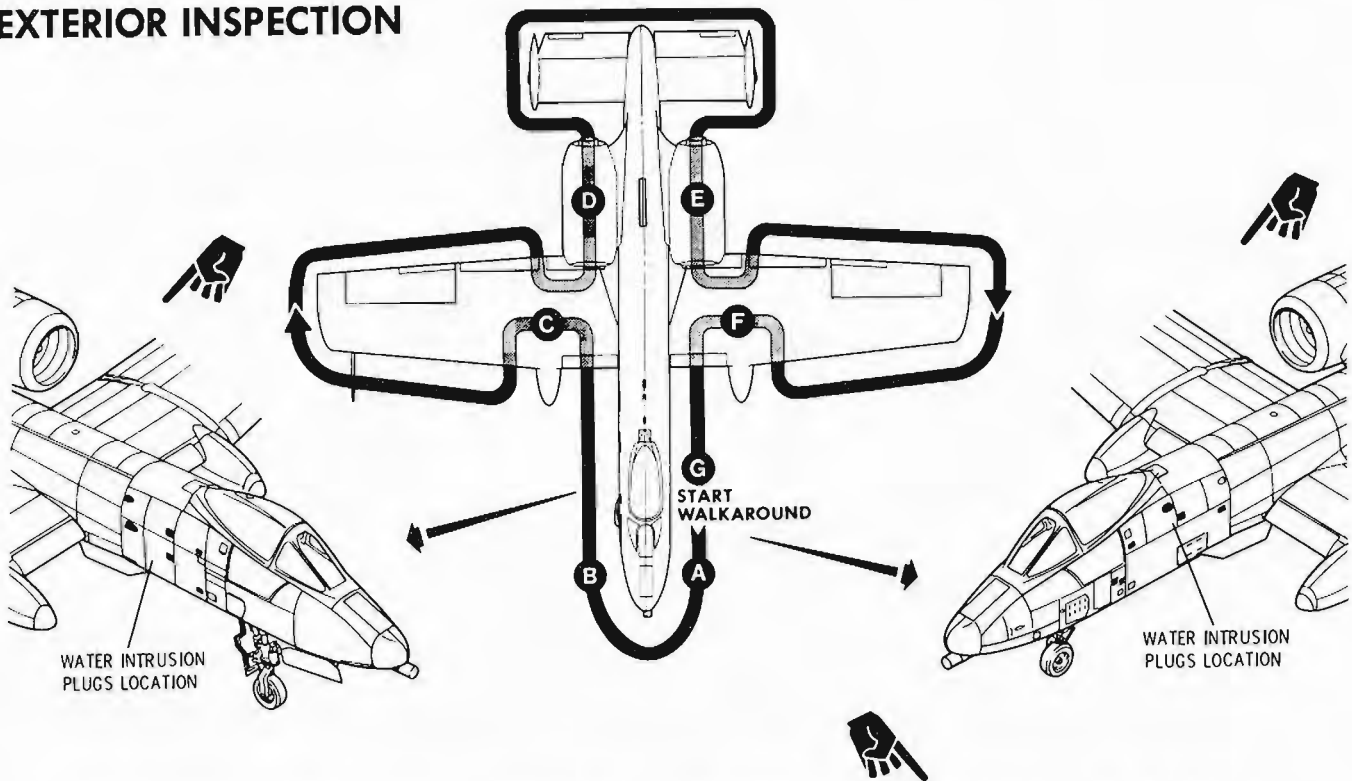

DURING THE EXTERIOR INSPECTION, THE AIRCRAFT SHOULD BE CHECKED FOR GENERAL CONDITION, COVERS AND PLUGS REMOVED, WHEELS CHOCKED, ACCESS DOORS AND FILLER CAPS SECURED, AND FOR HYDRAULIC FLUID, OIL AND LEAKS, AS WELL AS FOR THE FOLLOWING SPECIFIC ITEMS.

A LEFT FORWARD SECTION

- 1 ANGLE OF ATTACK VANE - CHECK.
- 2 EXTERNAL BATTERY SWITCH - ON.

NOTE

NO BATTERY POWER AVAILABLE IF EXTERNAL BATTERY SWITCH IS OFF.

B RIGHT FORWARD SECTION

- 1 GAU-8 SAFETY PIN - CHECK.
- 2 NOSEWHEEL - CONDITION.
- 3 NOSE GEAR STEERING LOCK CAP - SAFETY PIN REMOVED AND CAP SAFETIED.
- 4 BATHTUB DRAIN - CHECK.
- 5 SLAT SAFETY PIN - REMOVED.
- 6 BALLASTS - CHECK.
- 7 EMERGENCY ACCUMULATORS - CHECK PRECHARGE (PLACARD).
- 8 WINDSHIELD WASH QUANTITY - CHECK. [19]
- 9 GEAR SAFETY PIN - REMOVED.
- 10 UMBILICAL DISPLAY UNIT TEMS STATUS CHECK. [94]

C RIGHT CENTER SECTION

- 1 FUSELAGE FENCE - INSPECT FOR IMPACT DAMAGE.
- 2 MAIN LANDING GEAR STRUT CENTER DOOR - CHECK SAFETY PIN INSTALLED AND DOOR SECURE.
- 3 GEAR SAFETY PIN - REMOVED.
- 4 WHEEL WELL - CONDITION.
- 5 SPEED BRAKE SAFETY PIN - REMOVED.
- 6 MAINTENANCE RECORD STOWAGE CONTAINER IN WHEEL WELL - CLOSED AND SECURE [19].
- 7 PITOT TUBE/STATIC PORTS - CLEAR.

D RIGHT AFT SECTION

- 1 SPEED BRAKE - CONDITION.
- 2 FLAPS - CONDITION (NOTE POSITION).
- 3 ENGINE NACELLE - CONDITION.
- 4 RIGHT RUDDER/ELEVATOR - CONDITION.

E LEFT AFT SECTION

- 1 LEFT RUDDER/ELEVATOR - CONDITION.
- 2 ENGINE NACELLE - CONDITION.
- 3 AVTR - CHECK/INSERT TAPE (IF REQUIRED) [69]
- 4 APU HYD VALVE DOOR - CLOSED.
- 5 FLAPS - CONDITION (NOTE POSITION).
- 6 SPEED BRAKE - CONDITION.

F LEFT CENTER SECTION

- 1 LIFT TRANSDUCER VANE - CONDITION.
- 2 MAIN LANDING GEAR STRUT CENTER DOOR - CHECK SAFETY PIN INSTALLED AND DOOR SECURE.
- 3 GEAR SAFETY PIN - REMOVED.
- 4 WHEEL WELL - CONDITION.
- 5 SAFETY PIN POUCH - CHECK SECURE.
- 6 GROUND REFUELING DOOR - CLOSED.
- 7 FUSELAGE FENCE - INSPECT FOR IMPACT DAMAGE.

G FROM BOARDING LADDER

- 1 UPPER SURFACES - CHECK.

Figure 2-1

BEFORE ENTERING COCKPIT

1. Canopy actuator — Check locked.

NOTE

- If the canopy actuator is disengaged by use of the internal or external canopy actuator disengage lever, the locking system must be reset by maintenance personnel. Canopy disengagement is indicated by a small orange-yellow triangle on the actuator unlock hook, which is located at the top end of the canopy actuator and visible from the left side of the aircraft.

2. Canopy controls — Check.
 - a. Canopy actuator disengage level — Full forward.
 - b. Canopy jettison handle — Full forward, safety pin removed.
3. Ejection seat — Check.
 - a. Seat ground safety lever — SAFE (UP).
 - b. Ejection handles — Secured.
 - c. Ejection handles safety pin (left handgrip) — Removed.
 - d. Survival kit — AUTO.
 - e. Radio locator beacon — A (AUTO) or M (MANUAL) (as required).
 - f. Survival kit and lap belt connections — Check secure.
 - g. Emergency oxygen bottle supply — Check.
 - h. Seat hose disconnect fitting — Engaged and safety wired.
 - i. Parachute and harness connection -- Check
Make sure threaded retaining pins are:
 - (1) (FLUSH SCREW) Flush or below surface.
 - (2) (SLOTTED SCREW) Head underside seated against link assy.
 - j. Pitot tubes — Check clear and undamaged.

- k. Battery indicator — Check white.

- l. Restraint emergency release handle — Secure, safety pin removed.

4. Flight publications — Check (as required.)

COCKPIT INTERIOR CHECK

1. Loose or foreign objects — Check.
2. Camera cover/film pack — Installed 68.
3. Strap-in connections — Check.
 - a. Anti-g hose — Connect.
 - b. Survival kit — Connect and adjust.
 - c. Lap belt — Connect and adjust.
 - d. Shoulder/parachute straps — Connect.

NOTE

The shoulder/parachute straps shall be pulled from the inertia reel simultaneously. Pulling straps out individually during strap-in may cause the inertia reel to jam.

- e. Aircraft oxygen hose — Connect.
- f. Emergency oxygen hose — Connect.
- g. Communications lead — Connect.
4. Rudder pedals — Adjust.

LEFT CONSOLE

1. Armament/ground safety override switch — SAFE (guard down).
2. Utility light — Stowed.
3. IFF antenna — BOTH.
4. UHF antenna — As required.
5. Radar beacon switch — OFF.
6. CTVS/AVTR control panel — OFF 69.
7. KY-28 or KY-58 — OFF/set.
8. Intercom control panel — Set.

T.O. 1A-10A-1

9. VHF/FM control panel — OFF/set.
10. UHF control panel — ON/set.
11. VHF/AM control panel — OFF/set.
12. Emergency flight control panel — Set.
 - a. Flap emergency retract switch — Unmarked, aft position.
 - b. Insure flight control mode switch — NORM.
 - c. Insure aileron emergency disengage switch — Center position.
 - d. Insure elevator emergency disengage switch — Center position.
 - e. Insure speed brake emergency retract switch — Unmarked, aft position.
 - f. Insure pitch/roll trim override switch — NORM.
13. TV monitor power switch — OFF.
14. IFF — OFF/set.
15. HARS/SAS override switch — NORM 64 .
16. Refuel status and indexer light control — Set.
17. Weapon station status light control — Set.
18. Master exterior light control switch — Aft.
19. Throttles — OFF.
20. Flap lever — Set to flap position.
21. Throttle friction control — Set.
22. Speed brake control — Set to center (HOLD) position if speed brakes are open; set to closed position if speed brakes are closed.
23. APU switch. — OFF.
24. Engine operate switches — NORM.
25. Engine fuel flow switches — NORM.
26. Fuel system control panel — Set.
 - a. Main boost pump switches (L and R) — MAIN.
 - b. Wing boost pump switches (L and R) — WING.
 - c. Main fill disable switches (L and R) — Depress.
 - d. Wing fill disable switches (L and R) — Depress.
 - e. Air refuel control — CLOSE.
 - f. Tank gate switch — CLOSE.
 - g. Crossfeed switch — OFF.
 - h. External tank switches (WING and FUS) — OFF.
 - i. Signal amplifier switch — NORM.
27. Emergency brake handle — Push IN (if starting left engine first); pull OUT (if starting right engine first).

INSTRUMENT PANEL

1. Landing gear handle — DOWN.
2. Landing/taxi light switch — OFF.
3. Armament control panel — Set.
 - a. Master arm switch — SAFE.
 - b. EO PWR switch — OFF.
 - c. Gun rate switch — SAFE.
 - d. Electric fuzing switch — SAFE/
103 AIM-9 mode switch — OFF.
 - e. Release mode selective jettison — OFF.
 - f. Mechanical fuzing switch — SAFE.
 - g. Store loading display — Check.
 - h. Weapon station select switches — Deselected.
4. Clock — Set.
5. HUD mode selector — OFF.

6. Standby attitude indicator — CAGE.
7. Accelerometer — Reset.
8. Fire handles — In.
9. Fire extinguisher discharge switch — Center position.
10. Standby compass — Check.
11. Auxiliary landing gear extension handle — In.
12. Circuit breakers — Check closed.

RIGHT CONSOLE

1. Electrical power control panel — Set.
 - a. APU generator switch — OFF/RESET.
 - b. Inverter switch — OFF.
 - c. AC generator switches — PWR (L and R).
 - d. Battery switch — OFF.
 - e. Emergency flood light switch — As required.
2. ECM — OFF (if installed.)
3. ILS control panel — OFF/set 47 .
4. CDU — OFF/set 62 .
5. Chaff/flare control panel — Set 45 .
 - a. Flare jettison switch — Aft to safe.
 - b. Chaff mode selector knob — OFF.
 - c. Flare mode selector knob — OFF.
6. Oxygen system — Check. (PRICE)

Perform PRICE check and set as required.

- a. Pressure (P) — Check 55 - 145 psi.
- b. Regulator (R) — Check condition.
 - (1) Emergency level — Normal.
 - (2) Diluter lever — Normal.

(3) Supply lever — OFF (unless safety wired ON). Check that you cannot inhale through the oxygen system.

WARNING

- If it is possible to inhale through the oxygen system with the supply lever OFF, the regulator is malfunctioning and may not be safe for flight.

(4) Supply lever — ON. Check for normal breathing.

NOTE

- The CRU-73/A diluter-demand regulator will automatically (internally or by switch interlocking) switch from NORMAL OXYGEN to 100% OXYGEN when the SUPPLY lever is shut OFF, blocking airflow as a warning that the regulator is OFF.

c. Indicator (I) — Check for flow indication (white) on inhalation and a no flow indication (black) on exhalation.

d. Connectors (C) — Check. Check condition and security of connectors (10 - 20 pound pull required to separate the aircraft hose from the crew connector).

(1) Diluter lever — 100%.

(2) Emergency lever — EMER. Check for leaks. Positive pressure should be supplied to the mask. Hold breath and check for a no flow (black) indication. Leaks will be detected by a flow indication (white) and must be corrected before flight.

NOTE

- When placing the emergency lever in either EMERGENCY or TEST-MASK, the oxygen mask must be fitted to the face. Continuous delivery of oxygen at a positive pressure with a leaking mask or with the mask removed for extended time periods will deplete the oxygen supply rapidly, and will result in extremely cold oxygen and possible flow of liquid oxygen into the regulator.

T.O. 1A-10A-1

- e. Emergency (E) — Check.
 - (1) Emergency bottle connections.
 - (2) Emergency lever — Hold to test mask and check for positive pressure and leaks at the mask.
7. Environment control panel — Set.
 - a. Windshield defog/deice switch — OFF.
 - b. Canopy defog control — OFF.
 - c. Rain removal switch — OFF.
 - d. Pitot heat switch — OFF.
 - e. Bleed air switch — BLEED AIR.
 - f. Main air switch — SUPPLY.
 - g. Temperature/pressure control — NORM.
 - h. Flow level control — As required.
 - i. Air conditioner control — OPER AUTO.
 - j. Temperature level control — As required.
8. TACAN control panel — OFF/set.
9. Lighting control panel — Set.
10. HARS control panel — Set.

PRIOR TO ENGINE START

Before starting the engine, make sure that danger areas (figure 2-2) fore and aft of the aircraft are clear. Refer to Section V for starting exhaust gas temperatures.

1. Battery switch — PWR.
2. Inverter switch — STBY.

NOTE

- The following caution lights should go out: INST INV, L/R ENG HOT.
3. Engine instruments — Check. ITT indicator reads below 150°C, OFF flag not visible.

4. Fire detect/bleed air leak test button — Depress. Lights in the fire handles and the BLEED AIR LEAK caution lights should come on.

5. Gear lights — Check.

6. Signal lights — Test.

7. Fuel quantity — Check.

- a. Test indicator button — Depress. L and R pointers will read 3,000(±300) pounds, totalizer will read 6,000(±400)pounds.

- b. Fuel display selector — Verify total by checking in each position and reset to MAIN.

8. Oxygen quantity — Check.

- a. OXY LOW caution light — OFF.

- b. OXY IND TEST button — Depress.
(OXY LOW caution light comes on at 0.5 liter)

9. APU switch — START (or signal for external air).

WARNING

- If external electrical power is required to start APU because of a weak or dead battery, the battery may not recharge enough to start the APU in the event of a dual engine flame-out/dual generator failure.

10. L-FUEL PRESS light — Check off.

NOTE

- The L-FUEL PRESS light being off confirms operation of DC fuel boost pump only if AC electrical power is not operating the main and wing fuel boost pumps. If L-FUEL PRESS light is on and the DC FUEL PUMP circuit breaker is closed, abort the aircraft for an inoperative DC fuel boost pump.

11. APU generator switch — PWR. Confirm APU generator caution light is off. If light remains on, recycle generator switch to OFF/RESET, then to PWR.

CAUTION

- The APU generator is the only source of power for electric fan cooling of the APU hydraulic pump. Therefore, do not operate the APU for more than 5 minutes with the APU generator OFF.

12. Seat — Adjust.

NOTE

- INS alignment may be initiated at this time, but normally is accomplished after engine start.

STARTING ENGINES

NOTE

- Normal brakes will be available if the left engine is started first. Should the right engine be started first, pull the emergency brake handle.

If the right engine must be started first without AC power available, select CROSSFEED to provide positive fuel pressure. Pull out EMER BRAKE handle.

1. Left engine — Start.

a. Manual starting system 11.

(1) Left engine operate switch — MOTOR (ENG START CYCLE light on and core rpm increasing).

DANGER AREAS

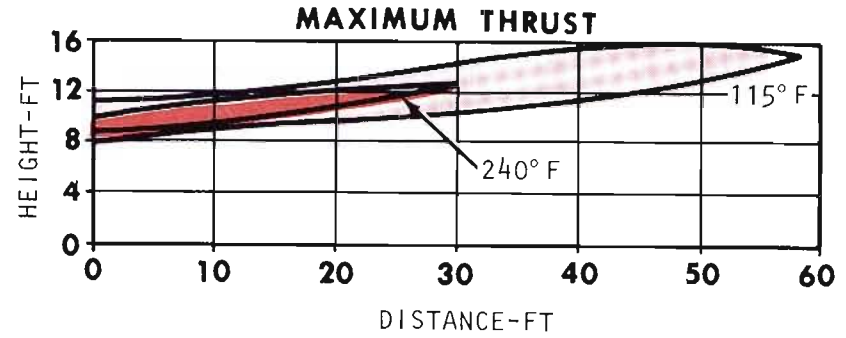
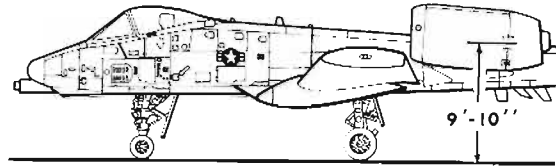

LEGEND

- TEMP PROFILE
- - - VELOCITY PROFILE

WARNING

ANTENNAS
 MAINTAIN AT LEAST TWO FEET
 DISTANCE FROM OPERATING ANTENNAS.

Figure 2-2.

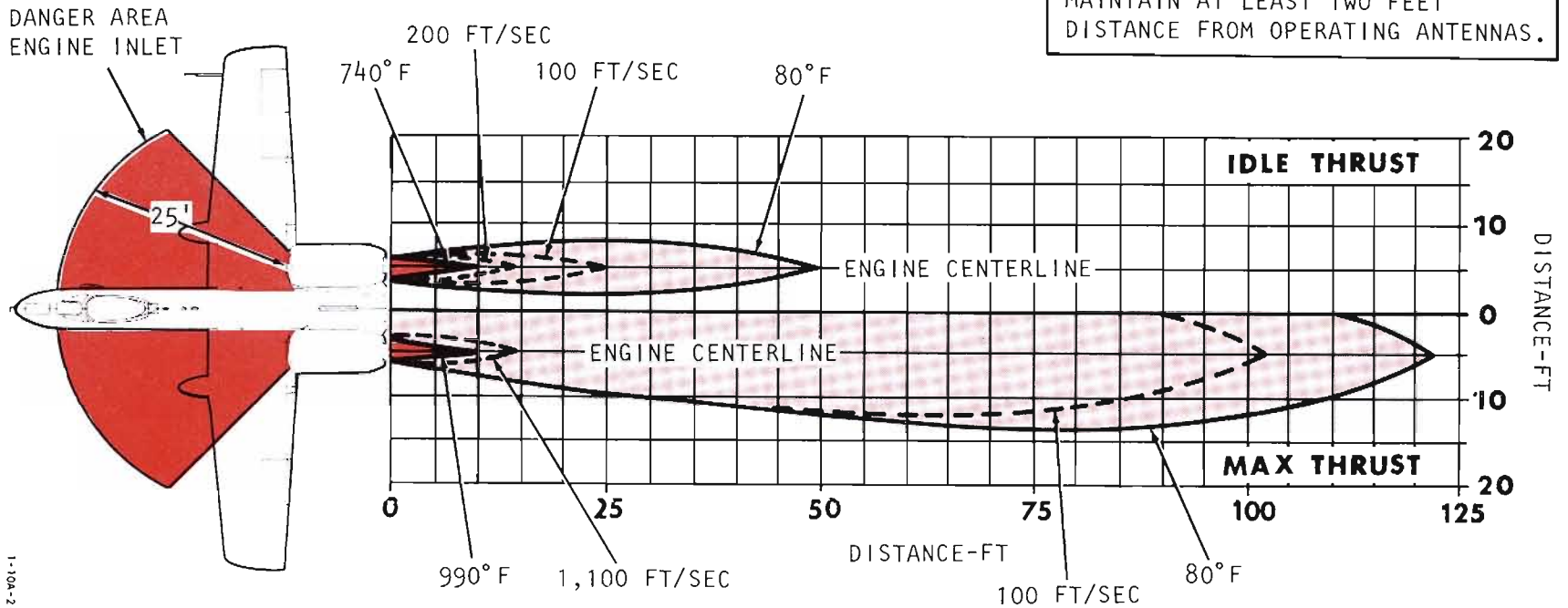

Change 6

2-7

1-10A-2-4

T.O. 1A-10A-1

T.O. 1A-10A-1

(2) Left ignition button — Depress momentarily, when ITT is below 150°C.

CAUTION

- Attempting start with ITT above 150°C will result in overtemp.

(3) Left throttle — IDLE.

(a) ITT — Check.

If ITT does not rise within 20 seconds, retard throttle OFF, dry motor engine for 30 seconds, wait 1 minute, and reattempt start.

(b) Oil pressure — Check rising.

(c) Hydraulic pressure — Check full pressure at approximately 40% core rpm.

(d) L-GEN light — Check off at approximately 52% core rpm.

(4) Left engine operate switch — NORM within 10 seconds after 56% core rpm and after ITT peaks (ENG START CYCLE light should go off).

CAUTION

- Minimize engine motor time at engine idle speed. Failure to return the engine operate switch to NORM within 30 seconds after the engine reaches 56% core rpm may damage the ATS.

b. Automatic starting systems 8 and 45.

Prior to engine start it will be necessary to motor the engine if the ITT is above 150°C.

CAUTION

- Attempting start with ITT above 150°C will result in overtemp.

(1) Left throttle — IDLE (ENG START CYCLE light on and core rpm increasing).

(a) ITT — Check.

If ITT does not rise within 20 seconds, retard throttle OFF, dry motor engine for 30 seconds, wait 1 minute, and reattempt start.

(b) Oil pressure — Check rising.

(c) Hydraulic pressure — Check full pressure at approximately 40% core rpm.

(d) L-GEN light — Check off at approximately 52% core rpm.

(2) ENG START CYCLE light — OFF (old auto start aircraft — 56% core rpm, new auto start aircraft — 10 seconds after 56% core rpm).

Insure ENG START CYCLE light goes off within 30 seconds after 56% core rpm.

2. Left engine instruments — Check.

a. Idle RPM — Check.

Engine should accelerate to at least minimum idle speed core rpm limits within 60 seconds. Recheck rpm after 2 minutes stabilization.

CAUTION

- For the idle speed check to be valid, the throttle must be firmly against idle stop until after the check is complete.
- Shut down engine if it does not idle at or above the minimum core rpm limit to reduce the possibility of stage one compressor blade damage.

NOTE

A slow start may occur on the first start of the day due to combustion energy loss from heating a cold engine. If a slow start occurs on the first start of the day, a second start may be attempted. If the second start is not within limits, abort the aircraft.

BEFORE TAXIING

1. CDU - As required for alignment [62].
2. CTVS/AVTR control panel - STBY [69].
3. Anti-g suit - TEST.
4. Radios - As required.
5. TV monitor switch - POWER (if EO weapon loaded).
6. IFF - STBY.
7. Air refueling door - Check (if required).
8. Crossfeed - OFF.
9. Emergency brake handle - Full forward.
10. HUD mode selector - TEST.
11. RWR - PWR.
12. Armament control panel lights - Test.
13. Navigation mode select panel - Set.
14. TISL - CAGE (as required).
15. ILS PWR control knob - PWR [47].
16. TACAN mode selector switch - TR.
17. Windshield defog/deice switch - DEFOG/DEICE (if required).
18. signal lights - Test.
19. Flaps - Cycle.
20. Speed brakes - Check.

Open speed brakes, and white speed brakes are opening, set the speed brake emergency retract switch to EMER RETR. Speed brakes should stop moving and hold. Move speed brake switch to full close, then full open while checking that speed brakes do not move. Return speed brake emergency retract switch to the unmarked position. Close speed brakes slightly, then to full open. Speed brakes should go from hold to full open (100%). Slight speed brake reversal may occur during this step. With speed brakes open, check aileron movement, check for binding. Move speed

brake switch to full close; speed brakes should fully close.

NOTE

- Speed brakes may not close simultaneously due to lack of airloads.
21. Flight controls - Check.
 - a. SAS switches - OFF.
 - b. Free and correct movement of control surfaces.
 - c. Hydraulic pressure - Check.
 - d. Full cycle controls - Verify no aileron/rudder interconnect [83].
 22. SAS - Check.
 - a. Anti-skid switch - ANTI-SKID.
 - b. SAS switches - ENGAGE.

NOTE

- If the L-R YAW SAS switches do not remain engaged, use the takeoff trim button to center stick and flight controls. Reattempt to engage SAS switches.
- c. Monitor test switch - L (hold). Check all SAS switches disengage.
 - d. SAS switches - ENGAGE.
 - e. Monitor test switch - R (hold). Check all SAS switches disengage.

NOTE

- On [53], after each operation of monitor test switch, wait 15 seconds before activating switch in same direction.
- f. SAS switches - ENGAGE.
 - g. Emergency disconnect lever - Depress. Check SAS, anti-skid switches - OFF.
 - h. SAS switches - ENGAGE.
 - i. Aileron/rudder interconnect - Check [83]. Operate ailerons, verify rudder movement (L aileron up left rudder. R aileron up right rudder).

j. Pitch trim compensator — Check. Open speed brakes to 40%. Crew chief verifies elevator trailing edge moves down approximately 1 inch. Close speed brakes and note elevator moves up.

23. Trim — Check.

Check travel of pitch, roll and yaw trim in both directions. Check for positive left/right stop of yaw trim knob. Check emergency trim in pitch and roll.

NOTE

- The yaw SAS must be engaged to obtain operation of the yaw trim function.

24. Takeoff trim button — Depress. Check T/O TRIM light comes on.

NOTE

- Yaw trim must be neutral and the pitch/roll trim override switch in NORM before the takeoff trim light will come on.
- The TAKEOFF trim indicator light is the only positive check the pilot has that the elevator tab trim motors are neutrally positioned for a potential inflight transfer to the manual reversion flight control mode.

25. Brakes — Check.

Crew chief checks for proper operation.

- Anti-skid switch — ANTI-SKID.
- Anti-skid switch — OFF.

26. Slat operation, peak performance tone, and stall warning tone — Check (insure pitot heat switch — OFF).

Crew chief will actuate the lift transducer until slats extend. Crew chief will check left slat operation while pilot checks right slat operation. Steady peak performance and chopped stall warning tones should be heard in the headset. With the DC SPS circuit breaker pulled, the slats will remain extended.

27. Pitot heat — Check.

28. IFF — NORM/TEST/STBY.

After 1-minute warmup, test each mode. Go condition indicated by the TEST lamp coming on.

29. TV Monitor — Test (if required).

TV monitor test and operating procedures are described in T.O. 1A-10A-34-1-1.

30. HUD — Set mode and altitude display.

On [25] display should agree with altimeter reading ± 85 feet.

31. CTVS/AVTR BIT — Check [69] [98] .

32. Radar warning system — Test and set as required.

RWR system test and operating procedures are described in T.O. 1A-10A-34-1-1.

33. ECM — STBY (if installed).

34. TACAN — Test.

35. Flight instruments — Check.

- ADI — Check movement.

Pitch trim arrow aligned with reference mark.

- HDG — SYNC (if sync indicator indicates it is necessary).

- Standby attitude indicator — UNCAGE.

- VVI — Zero.

- Airspeed indicator — Check.

36. Altimeter — Set/Check.

Set local barometric pressure setting. Check altimeter agrees within ± 75 feet of field elevation in both ELECT (RESET) and PNEU (STBY) modes. The ELECT (RESET) and PNEU (STBY) modes should agree within 75 feet.

After INS alignment is complete:

37. CDU mode selector knob — NAV. INERTIAL NAV caution light should go out [62] .

38. Navigation mode select panel—NAV CRS 62 .
39. INS — Check 62 .
 - a. CDU STR toggle switch — Desired steerpoint.
 - b. HUD mode selector — TEST.
 - c. HUD mode selector — NAV. Compare known bearing and distance of desired steerpoint.
 - d. CDU page selector knob — INS.
 - e. CDU test line key — Depress. TEST page appears.
 - (1) CDU — Test.
 - (2) CADC — Test.
 - (3) MBC — Test.

f. Navigation mode select panel -- MAN.
Observe course window, course arrow, and CDI are nonfunctional and TO-FROM and bearing validity are out of view.

g. Navigation mode select panel -- HARS.
Observe ADI and HSI indicators jump slightly and HUD display reverts to HARS mode.

40. INS data -- Record [62].
41. Navigation mode select panel -- As desired.
42. TISL -- Check (if required).
 - a. Mode switch -- CAGE.
 - b. BITE switch -- Depress.

The DET and ACD lights will come on during the BITE sequence. Equipment failure is indicated if one or both lights remain on longer than 20 seconds.

43. APU generator switch -- OFF/RESET (prior to APU shutdown).
44. APU switch -- As required.

Above 75°F the ECS and APU should be operated to provide adequate cooling for INS system.

CAUTION

- Allow at least 2 minutes after ENG START CYCLE light goes off, before APU shutdown.

45. Ladder -- Stowed.
46. Idle core RPM -- Check.

a. Rapidly move throttle from IDLE to MAX, then with hard chop motion back to IDLE (IDLE-MAX-IDLE in 2 seconds or less).

CAUTION

- If CIT sensor has failed, stage 1 compressor blades may be damaged above 70% core RPM.

NOTE

- When throttle is moved from IDLE-MAX-IDLE in 2 seconds or less, core RPM will not exceed 70%.
 - b. Stabilize at IDLE for 10 seconds with throttle against IDLE stop.
 - c. Check core RPM versus ambient temperature (Minimum Idle Speed Chart, Section V).
If core RPM is below minimum computed:
 - d. ABORT.
- 47. Chocks -- Removed.

TAXI

See figure 2-3 for minimum turning radius and ground clearance.

CAUTION

- Do not adjust rudder pedals during taxi.
 1. Nosewheel steering -- Engage.

NOTE

- Nosewheel steering must be engaged, at least momentarily, prior to each flight to ensure full charge within the damping mode compensator.
 2. Throttles -- As required.
 3. Brakes -- Checks.

CAUTION

- A power interruption to the landing gear control valve can cause simultaneous loss of nose wheel steering and normal brakes. Use the emergency brake system to stop the aircraft. Use extreme caution when taxiing in the vicinity of obstructions.
 4. Turn needle -- Check.

TURNING RADIUS AND GROUND CLEARANCE

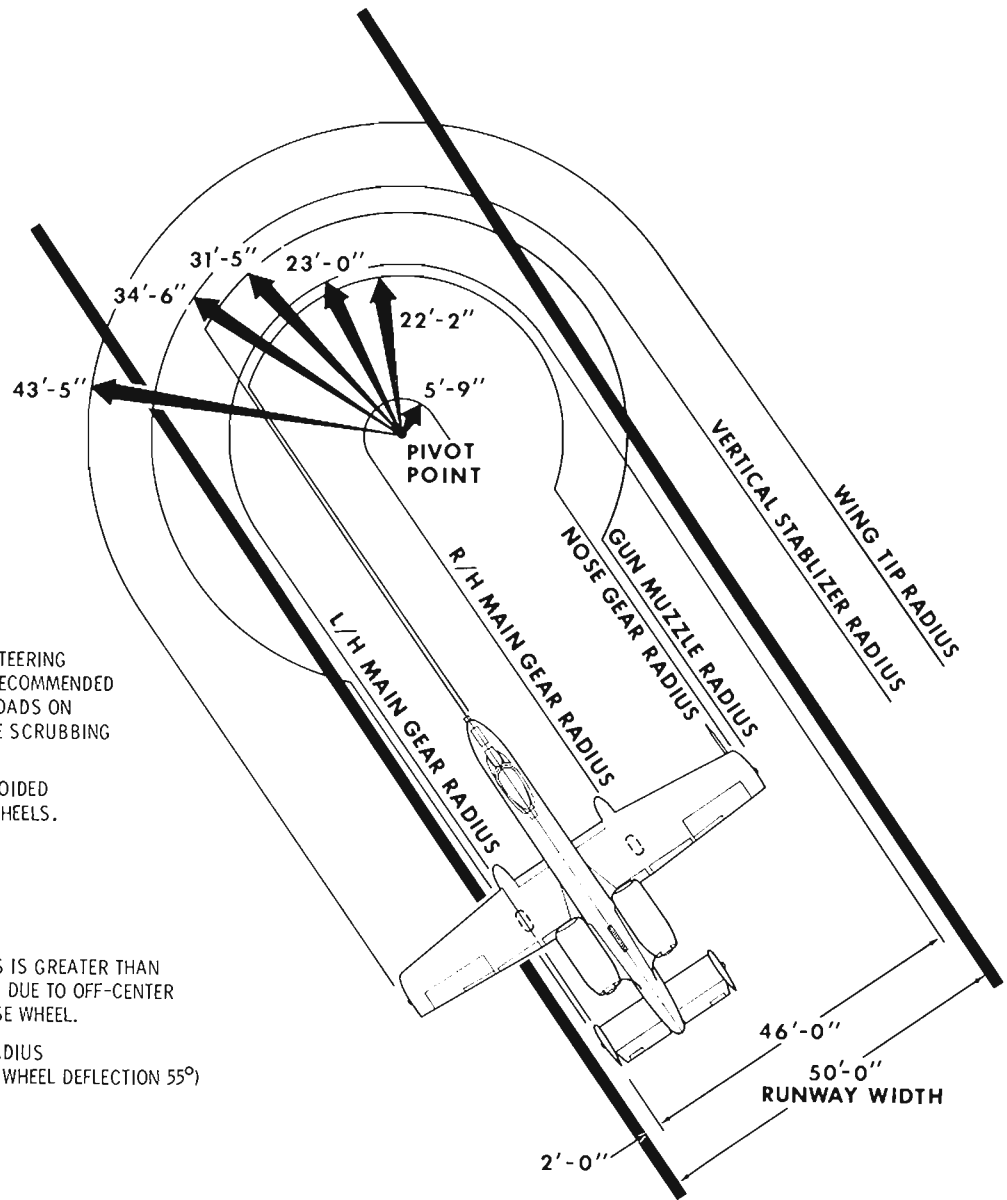

CAUTION

- SIMULTANEOUS USE OF NOSEWHEEL STEERING AND DIFFERENTIAL BRAKING IS NOT RECOMMENDED AS THIS MAY PRODUCE UNDUE SIDeloadS ON THE NOSEGEAR BECAUSE OF POSSIBLE SCRUBBING OF THE NOSE AND MAIN WHEEL TIRES.
- LOCKED WHEEL TURNS SHOULD BE AVOIDED TO PREVENT DAMAGE TO TIRES AND WHEELS.

NOTE

- R/H TURN RADIUS IS GREATER THAN L/H TURN RADIUS DUE TO OFF-CENTER LOCATION OF NOSE WHEEL.
- TAXI TURNING RADIUS (MAXIMUM NOSE WHEEL DEFLECTION 55°)

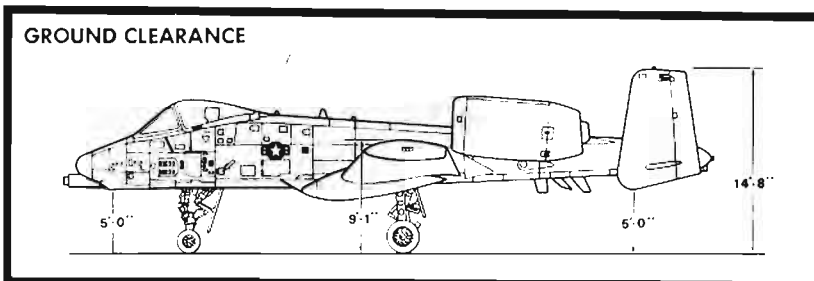

Figure 2-3.

BEFORE TAKEOFF

1. Engine instruments -- Check.

CAUTION

- Idle RPM below computed minimum indicated possible CIT sensor failure; abort.
 - Stabilized idle ITT above 675°C could indicate a failing outer transition liner; abort.
2. Flaps -- Set for takeoff.

3. Speed brakes -- CLOSED.
4. IFF -- As required.
5. Takeoff trim -- Check.
6. TACAN -- Set.
 - a. Nav mode select switch -- TCN.
 - b. Course selector window -- Dial in mag bearing of bearing pointer number 1.
 - c. CDI -- $\pm 2^\circ$ of center.
 - d. Rotate the course set knob until the CDI is deflected $\pm 10^\circ$. Check that the course select window correctly displays the change.

7. Oxygen regulator -- As required.
8. Canopy defog control -- As required.
9. Windshield defog/deice switch -- As required.
10. Canopy -- Closed and locked (light off).
11. Ejection seat ground safety lever -- ARMED.
12. Exterior lights -- As required.

LINEUP CHECK

1. Flight instruments -- Check.
2. Anti-skid switch -- ANTI-SKID.
3. Pitot heat switch -- PITOT HEAT.
4. Throttles -- 90% core rpm.
5. Engine instruments -- Check.
6. Warning and caution lights -- Off.

TAKEOFF

1. Nosewheel steering -- As desired.
2. Brakes -- Release.
3. Throttles -- MAX.
4. Engine instruments -- Check.

WARNING

- Fan speeds less than the predicted fan speed will result in reduced single-engine rate of climb, and will adversely affect other takeoff parameters. Under critical operating conditions (short runway, high gross weight, high temperature, pressure altitude, etc.) an abort may be the appropriate action if predicted fan speed cannot be achieved.

NOTE

- Fan speed should be checked after approximately 1,000 feet on takeoff roll.

During takeoff, maintain directional control using nosewheel steering until the flight controls become effective. At approximately 10 knots below computed takeoff speed, apply back pressure to the

stick to begin establishing a takeoff attitude by increasing the pitch attitude to 10°.

CAUTION

- For proper clearance, when carrying external fuel tanks, assure all gear are in ground contact, when crossing the arresting gear cables.

CROSSWIND TAKEOFF

Crosswind produces a tendency to weather-vane (turn into the wind), and will tend to raise the upwind wing. Slight aileron into the wind will keep wings level, and moderate rudder inputs will be required to maintain track on runway centerline. The normal takeoff procedure should be used, except that the nosewheel steering should be left engaged to 70 KIAS for crosswind components in excess of 20 knots. If the nosewheel steering is left engaged higher than 70 KIAS the transient with nosewheel steering disengagement will be more severe but easily controllable. After nosewheel steering disengagement, rudder pedal force will be fairly high to maintain track on the runway. During rotation, rudder input should be slowly blended out to establish proper crab angle into the wind, so that when the aircraft becomes airborne, the flight path will be aligned with runway centerline.

AFTER TAKEOFF AND INITIAL CLIMB

Maintain takeoff pitch attitude during acceleration to climb speed. When safely airborne, retract the landing gear and at a minimum of 10 knots above takeoff speed, retract the flaps. Set power and pitch attitude as necessary to maintain climb schedule (TO 1A-10A-1-1).

FLIGHT

There is no requirement for the pilot to refer to the checklist during normal flight in the A-10. During climbout, after level off and at frequent intervals, the pilot should check his engine instruments as well as his fuel, cabin pressurization, and oxygen status. The correct altimeter setting should be used for each phase of the flight. The canopy defog and rain removal systems should be used as required to ensure visibility out of the aircraft.

CAUTION

- Prior to descent, canopy and windshield should be preheated using canopy defog and windshield DEFOG/DEICE to minimize fogging.

The canopy provides unrestricted visibility to the sides and overhead. Visual cues to changes in flight path are degraded when the canopy bow/sloping rail are not included in the field of view. This situation may readily occur during high bank angle maneuvering. Subtle undetected changes in flight path vector generally will not present a problem unless the aircraft is operating in a low altitude environment.

WARNING

- During low altitude maneuvering, the pilot must closely monitor the aircraft's flight path and attitude to prevent development of a hazardous flight path from which recovery is impossible.
- Do not exceed stall AOA. As AOA is increased above stall:
 1. Engine stall susceptibility is greatly increased.
 2. Aircraft drag is dramatically increased.

3. Aileron effectiveness is significantly decreased, especially when sideslip is present.

- If a stall is entered, relax aft stick to break the stall prior to attempting large roll inputs. Large aileron inputs beyond stall AOA will create sideslip, which increases engine stall susceptibility, and greatly reduces aileron effectiveness.

DESCENT/BEFORE LANDING

1. Altimeter -- Check.
2. INS/HARS -- Compare 62.

If a disparity exists between the HARS attitude and/or heading and INS attitude and/or heading, the disparity should be corrected prior to entering instrument conditions. If the disparity cannot be corrected, select the most accurate/reliable system.

WARNING

- If the HARS has precessed significantly and the INS subsequently fails - uncommanded yaw inputs and/or unreliable attitude reference may cause extreme spatial disorientation.
- 3. Canopy defog control -- As required.

4. Windshield DEFOG/DE-ICE — As required.
5. Speed brakes — As required.
6. Anti-skid switch — ANTI-SKID.
7. Landing light — As required.
8. Fuel quantity — Check.

INSTRUMENT APPROACHES

TACAN APPROACH

A typical TACAN approach is outlined in figure 2-4.

ILS APPROACH

A typical ILS approach is outlined in figure 2-5.

WARNING

- It is essential that raw ILS data be monitored at all times during an ILS ap-

proach. Disagreement between raw data and command (computed) steering must be taken as an indication that the command steering indications are unreliable, even with all warning flags out of view, and if the approach is continued use only raw data. Raw data is indicated on the CDI on the HSI, and on the GSI on the ADI. Command steering is given on the bank steering and pitch steering in bars on the ADI.

- On 46, the ILS and LSS switch indicators are adjacent. When depressed, both will present pitch and bank steering bars (ILS when within ILS transmitter range and LSS at all times). Inadvertent depression of LSS instead of ILS will present erroneous information that could cause flight outside approach obstruction clearance area.

RADAR APPROACH

A typical radar approach is outlined in figure 2-6.

TACAN PENETRATION AND APPROACH - TYPICAL

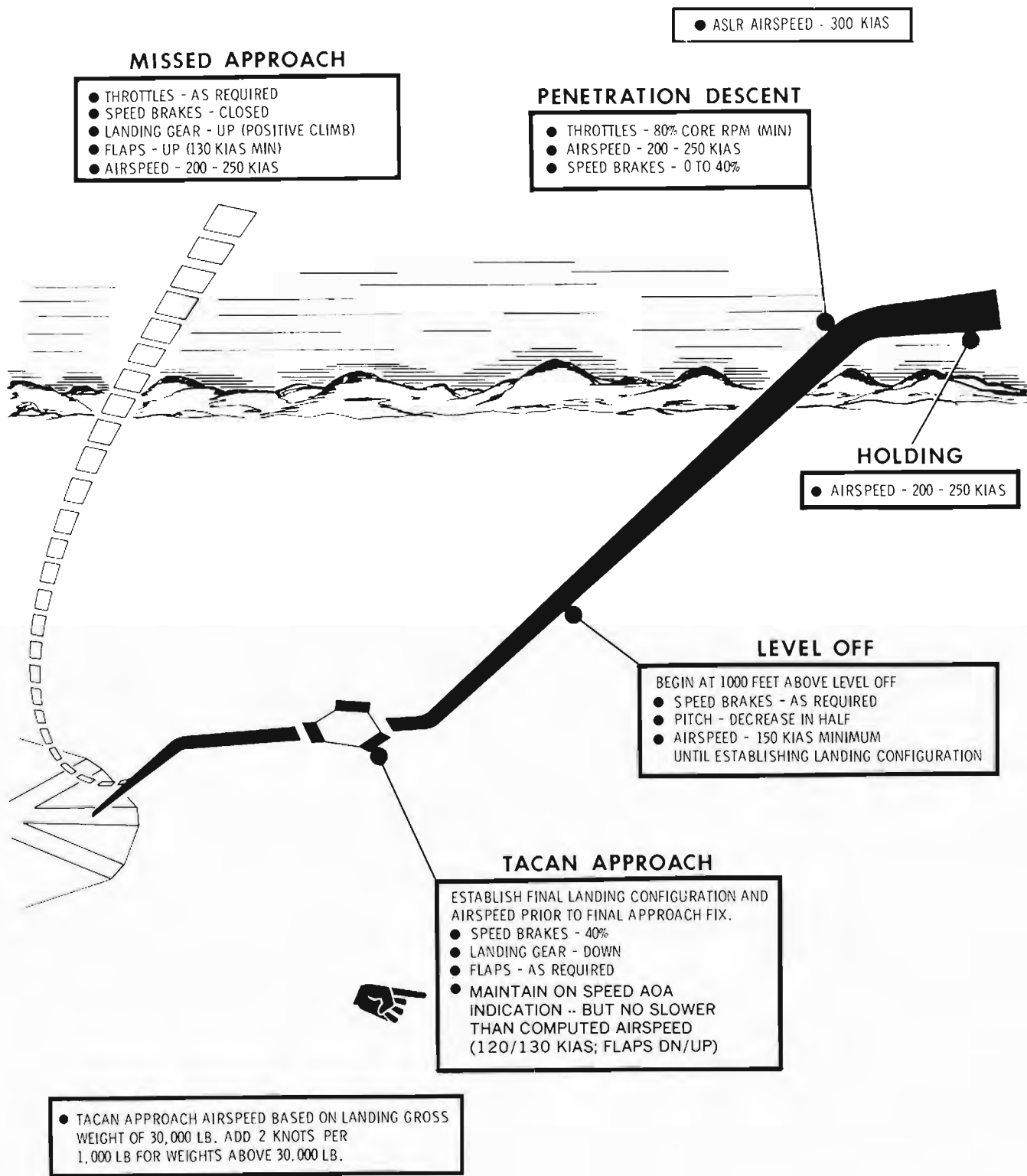
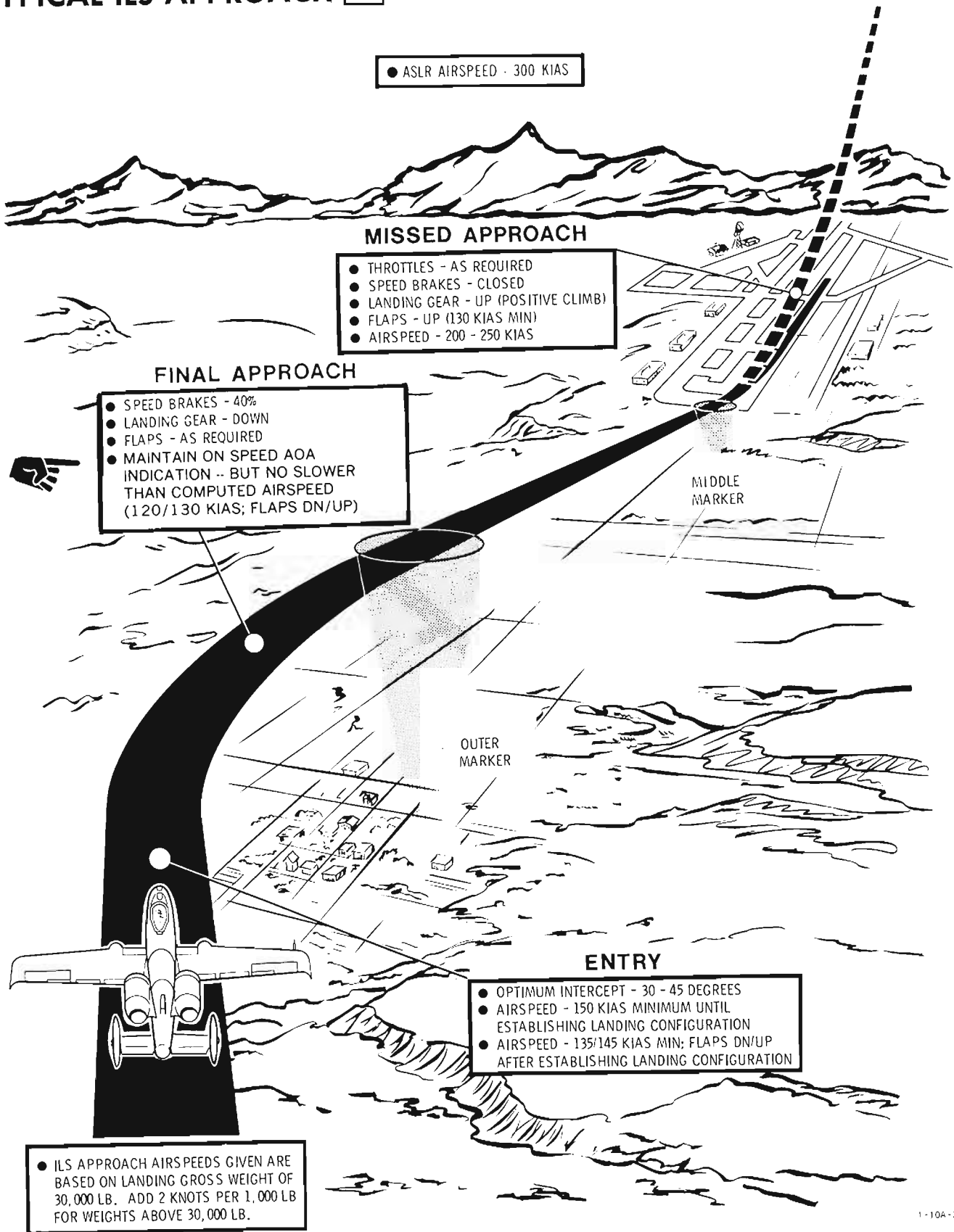

Figure 2-4.

TYPICAL ILS APPROACH 47



1-10A-2-1

Figure 2-5.

TYPICAL RADAR APPROACH - GCA

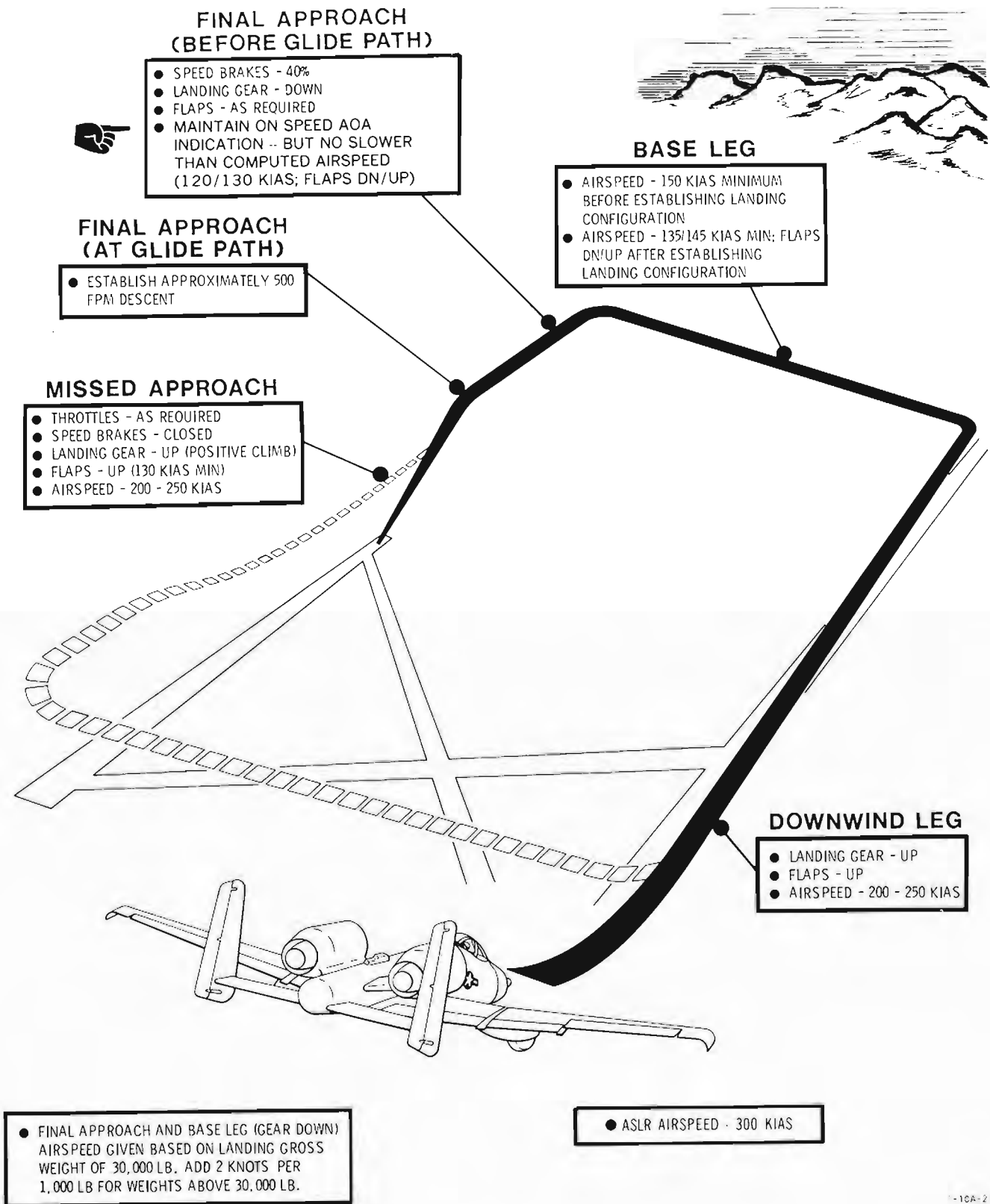

1A-10A-2-7

Figure 2-6.

STRAIGHT-IN-APPROACH

Establish a final approach configuration and airspeed and descent as required to reach a point 1 mile from the desired touchdown point at 300 feet above the ground. Final approach from this point is the same as for a normal pattern.

CIRCLING APPROACH

Circling approach prior to final is accomplished using on-speed AOA indication at 135/145 KIAS minimum flaps DN/UP (add 2 knots per 1,000 pounds above 30,000 pounds), landing gear DOWN, and speed brakes 40%. Circling approach is flown at a lower altitude than VFR patterns, therefore, the perception of the runway at this lower altitude causes most pilots to be too close to the runway for a safe approach. Allow sufficient room for the larger ground track turn radius required.

BEFORE LANDING

Refer to Section V for landing gross weight, cg, and crosswind limitations. Determine minimum final turn/base leg and final approach speed based on intended configuration, gross weight, and crosswind/gust conditions. See figures 2-4 through 2-7 for pattern and approach airspeeds. After configuring, check cockpit indicators to ensure intended configuration and check that the anti-skid and landing light are on.

In the final turn and on final approach, fly on-speed AOA, but no slower than computed airspeed. This will provide a safeguard against a malfunction in either the AOA system or airspeed indicator. An excessive discrepancy between computed airspeed and AOA indication will also alert the pilot that the flaps are not in the intended position.

WARNING

- Total reliance on either the AOA system or airspeed computation may result in a reduced stall margin.
- Sideslip will cause erroneous AOA indications and the stick shaker will not provide accurate stall warning.
- Engine acceleration from IDLE to MAX thrust requires approximately 10 seconds. This delay should be anticipated when planning thrust requirements in the landing pattern.

LANDING

At extreme forward cg's, near maximum aft stick is required for landing at the nominal flight manual speeds. Also at forward cg's the aircraft will respond less to pitch inputs, and stick forces will be higher than at mid cg loadings. At extreme aft cg conditions, the aircraft will respond more to pitch inputs, and stick forces will be lighter than at mid cg loadings.

CAUTION

- If an unusually high attitude exists upon touchdown, the tail of the aircraft may contact the landing surface. Incorrect flap position, fuel imbalance, heavy weight conditions, too slow final approach airspeed, high sink rates and excessive flare will aggravate this condition but are not necessary for damage to occur.
- Plan final approach to avoid touching down on arresting gear cables.

When landing is assured retard throttle slowly to IDLE. Touchdown speed for normal landing is 10 knots less than final approach airspeed. Landing distances are given in TO 1A-10A-1-1.

CAUTION

- For proper clearance, when carrying fuel tanks, plan touchdown to assure that all gear are in ground contact when crossing an arresting gear cable.

LANDING IN GUSTS

Landing in gusts procedure is the same as for normal landing except, add one half of gust factor to final approach and touchdown speeds. The gust factor is the difference between the average wind and gust wind speeds. If the average wind is 20 knots with gusts to 30 knots the gust factor would be 10 knots; add 5 knots to the final approach and touchdown speeds.

MINIMUM RUN LANDING

For a minimum run landing, the final approach speed (gear and flaps down and speed brakes 40%) should be reduced by 10 knots from the on-speed

TYPICAL OVERHEAD LANDING PATTERN

Gross Weight 30,000 lb

Add 2 Knots Per 1,000 lb For Weights Above 30,000 lb

For All Speeds Except Initial Approach Speed And Downwind Speed Prior To Configuring For Landing.

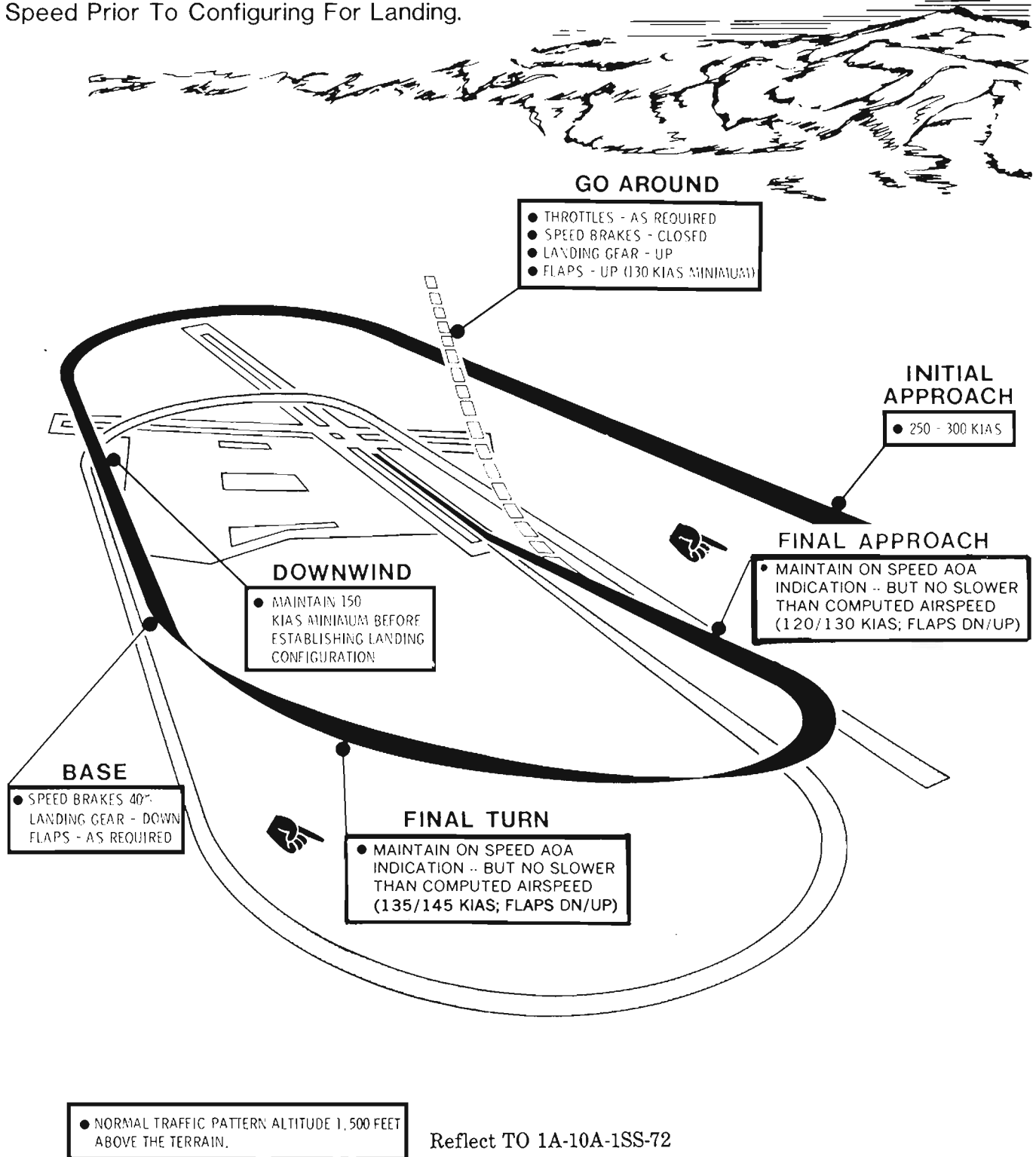

Reflect TO 1A-10A-1SS-72

Figure 2-7.

AOA indication or computed minimum, whichever is faster. The airspeed indicator should be used to fly a minimum run landing since the AOA indexer may indicate slow "V" (red) only, and will not provide sufficient guidance for a safe approach. Power should be sufficient to maintain the final approach speed and sink rate until touchdown. Select speed brakes 100% immediately after touchdown.

CAUTION

- Do not exceed sink rate limitations in Section V.
- The 10-knot lower approach speed results in an increase in AOA which, for the same flight path angle (rate of sink) as a normal approach, results in the aircraft being closer to the tail scrape angle. Attempting to flare before touchdown will increase the likelihood of tail scrape, particularly with aft cg loadings.
- A minimum run landing may require near maximum elevator deflection due to lower airspeed.
- Minimum run landing practice is prohibited when aircraft is configured with AGM/TGM-65 missiles mounted on bottom rail of LAU-88 launchers. Restriction is pending determination of an improved missile restraint method.

CROSSWIND LANDING

Normal landing procedures should be used in addition to the following techniques. The recommended final approach technique is to establish a combination of crab into the wind and wing low. A full crab final approach will lessen pilot workload on the rudder pedals but will degrade runway visibility for high crosswind components. Prior to flare, rudder input should be gradually increased to align the fuselage with the runway, and bank angle increased into the wind to maintain flight path towards the runway. Care should be exercised to maintain track down runway centerline. Touching down in a slight crab is acceptable, provided that a positive rudder correction is made to align the fuselage with the runway after touchdown. The aircraft track may diverge into the wind if a crab angle is maintained after touchdown. Crab angle at touchdown should be limited to 10° (runway visible through center windscreen) to prevent excessive gear loads.

2-20 Change 8

After touchdown, the crosswind produces a tendency to weathervane (turn into the wind), and must be corrected with rudder. Extending the speed brakes to 100% after nose gear lowering will cause the nose of the aircraft to cock slightly into the wind, and can be easily corrected with rudder. Maintain directional control by use of rudder, nosewheel steering, and differential braking as necessary. Nosewheel steering engagement will produce a transient dependent on the amount of rudder deflection. Severe transients can be avoided by momentarily neutralizing rudders prior to nosewheel steering engagement, and using nosewheel steering only as rudder effectiveness becomes degraded below 70 KIAS.

Refer to the table in Section V for crosswind component limitations. The effect of adding external stores is to destabilize the aircraft directionally, particularly in the flaps-up configuration, resulting in lower crosswind component limits.

For crosswind components above 20 knots, high sideslip angles are required to align the fuselage with the runway, and produce a significant error in airspeed and AOA indications.

CAUTION

- For crosswind components in excess of 20 knots, add 10 knots to recommended final approach and landing speeds (except single-engine approach speed) to compensate for airspeed indicator errors at high sideslip angles. The AOA system is unreliable at high sideslip angles and should not be used as a reference to final approach speed.

NOTE

- The use of large aileron deflections after touchdown is not required because of the wide tread of the main gear. On [83], the use of aileron could limit the amount of rudder available due to the effect of the aileron rudder interconnect.
- Pilot workload increases with SAS off, and large wind gust velocities.
- The aircraft characteristics in the ferry configuration also result in a further increased pilot workload.
- On [84], the SAS will counter attempts to kick out crab angle with a rapid rudder movement. SAS effects can be minimized by using gradual rudder inputs to align the fuselage with the runway.

TOUCH AND GO

After touchdown, smoothly advance both throttles and retract the speed brakes. The nosewheel may or may not contact the runway, depending on aircraft speed.

Close attention to directional control is required after touchdown, due to possible uneven engine acceleration and crosswinds. The rotation attitude for takeoff should be similar to a normal takeoff. Landing and takeoff speed should be computed prior to landing.

MISSED APPROACH

Should conditions dictate the execution of a missed approach, set throttles as required, close speed brakes, raise gear and flaps, and establish an instrument takeoff attitude. If subsequent instrument approaches are to be flown, set power to maintain 200 - 250 KIAS and a rate of climb not less than 1,000 feet/minute. When the desired missed approach altitude is reached, level off and maintain 200 - 250 KIAS.

AFTER LANDING

Maintain directional control using aileron and rudder as long as they remain effective, and then transition to nosewheel steering or differential braking. If available runway does not require maximum braking, speed can be reduced by aerodynamic braking or by extending speed brakes. Following aerodynamic braking, smoothly lower the nose to the runway prior to loss of elevator effectiveness. When the nosewheel touches down, do not attempt to raise it again. Speed brake effectiveness decreases rapidly with airspeed reduction. Brake heating is a function of aircraft configuration, groundspeed when brakes are applied, gross weight, ambient temperature, and pressure altitude. Operations within the danger and caution zones shown on the Wheel Brake Energy Limits Chart (figure 5-2) should be avoided when possible. If anti-skid is not used, the pilot must be alert to tire skidding and release brake pedal pressure, as necessary.

After touchdown:

1. Throttles — As required.
2. Speed brakes — As required.
3. Nosewheel steering — As required.

NOTE

- During anti-skid maximum braking with speed brakes extended, speed brakes may start an oscillatory motion that is self-sustaining. The resulting aircraft vibration can be felt by the pilot. Maintain braking as required and stop the oscillations by moving the control stick hard over to left or right after speed is reduced to a point where full aileron inputs will not create a directional problem or by closing the speed brakes after a safe stopping distance is assured.

After clearing runway:

4. Anti-skid switch — OFF.
5. Ejection seat ground safety lever — SAFE.
6. Canopy — As desired.
7. CTVS/AVTR control panel — OFF 69 98 .
8. TV monitor — OFF.
9. TACAN/ILS equipment — OFF.
10. IFF — Code switch HOLD (momentarily) and mode switch — STBY.
11. HUD night/day filter — DAY 53 .

CAUTION

- Failure to place the night/day filter to DAY prior to engine shutdown may cause damage to the red night filter due to prolonged exposure to sunlight.

12. HUD — OFF.
13. Landing/taxi lights — As required.
14. Radar warning system — OFF.
15. ECM — OFF (if installed).
16. Windshield defog/deice switch — OFF.
17. Pitot heat — OFF.
18. Position lights — Bright/Flash.

T.O. 1A-10A-1

19. Anti-collision lights — OFF.
20. Flaps — As required.

ENGINE SHUTDOWN

1. Brakes — Hold, until chocks are installed.
2. IFF — OFF.
3. Standby attitude indicator — CAGE.
4. INS — Perform terminal error update 62.
5. CDU mode selector knob — OFF 62.
6. TISL — OFF.
7. Seat — Full up.
8. Left throttle — OFF after 5 minutes at IDLE.

Taxi time may be included if core rpm does not exceed 80%.

Hold throttle against aft OFF stop until it can be confirmed that engine fuel has drained or engine rpm reaches 5% core rpm and ITT has decreased below 200°C. ITT should not increase past 540°C during heat soakback.

CAUTION

- Do not shut down the left engine if the APU is running, except in an emergency. The temperature of the APU exhaust gases is high enough to ignite the unused fuel being vented out of the left engine when it is shut down.
- If left engine is to be motored by using crossbleed air from right engine, normal brakes will not be available. Emergency brake handle should be pulled prior to advancing right throttle.

NOTE

- Shut down left engine first so that if motoring should be required the right engine can be used to motor the left engine.

9. Flight controls — Check.

After left hydraulic pressure bleedoff, check full travel response and feel of the ailerons, elevators, and right rudder.

10. Right throttle — OFF.

Hold throttle against aft OFF stop until it can be confirmed that engine fuel has drained or engine rpm reaches 5% core rpm and ITT has decreased below 200°C. ITT should not increase past 540°C during heat soakback.

CAUTION

- Right engine should not be shut down until left engine fuel has drained or left engine core rpm is below 5% and ITT has decreased below 200°C.
- If a rapid shutdown on the ground is necessary, the engine should be motored as soon as possible using APU, an operating engine if applicable, or external air. This action will prevent freeze-up due to uneven cooling.

11. Inverter switch — OFF.
12. Battery switch — OFF.
13. Communications equipment — OFF.

BEFORE LEAVING THE AIRPLANE

1. Canopy control switch — HOLD.

CAUTION

- Exercise extreme care when releasing lap belt and oxygen connections and laying them across the console to prevent damage to glass faceplates and control knobs on control panels.

2. Boarding ladder — As required.

WARNING

- Ensure no ground personnel are in proximity to door and ladder before extending.

CAUTION

- Do not hold boarding ladder switch depressed for more than 4 seconds as the latch relay may be damaged.

3. Emergency flood lights switch — OFF.

ALERT/COCKING

Perform the following prior to assuming alert status:

1. BEFORE EXTERIOR INSPECTION — Complete.
2. EXTERIOR INSPECTION — Complete.
3. INTERIOR INSPECTION — Complete.
4. PRIOR TO ENGINE START checklist — Complete.
5. STARTING ENGINES checklist — Complete.
6. BEFORE TAXIING checklist — Complete. (Do not select NAV with CDU mode selector knob if engines and APU are to be shut down.)

If engines and APU are to be shut down:

7. IFF — Code switch HOLD (momentarily).
8. CDU mode selector knob — OFF (when alignment is complete) 62.
9. Standby attitude indicator — CAGE.
10. IFF — OFF.
11. APU generator/APU — OFF.

12. Engines — Shut down.

If assuming out of cockpit alert status:

13. Battery switch — OFF.

NOTE

- If the above actions have not been completed prior to scramble, normal procedures should be used.
- The pilot and aircraft are placed on alert status IAW local policies and directives (i.e., with the pilot out of the cockpit, in the cockpit, in the cockpit with the APU running, and/or in the cockpit with the engines running).

SCRAMBLE (BEFORE TAXIING)

1. Strap-in connections — Check.
2. Battery switch — PWR (ensure inverter operation).
3. APU switch — START.
4. APU generator switch — PWR.
5. CDU mode selector knob — FAST 62.
6. Engines — Start.
7. Strobe lights — As required.
8. Altimeter/HUD — Set.
9. CDU mode selector knob — NAV (when NAV READY flashing) 62.

SCRAMBLE (BEFORE TAKEOFF)

1. Flaps — Recheck and set for takeoff.
2. Speed brakes — CLOSED.
3. IFF — As required.
4. SAS/Trim — ENGAGE/Check takeoff trim.

T.O. 1A-10A-1

5. Standby attitude indicator — UNCAGE.
6. NAV select panel — As required.
7. Canopy — Closed and locked (light off).
8. Ejection seat ground safety lever — ARMED.
9. Pitot heat switch — PITOT HEAT.
10. Exterior lights — As required.
11. Anti-skid switch — ANTI-SKID.
12. APU generator/APU — As required.
13. Warning and caution lights — Off.

HOT REFUELING

Dearming will be accomplished prior to entering the hot refueling pit. If suspected hot brakes or other unsafe condition exist, do not enter the refueling area. Follow ground crew directions into the refueling area and establish intercom with the ground crew. If any malfunction is suspected, stop refueling.

Hot refueling will not be conducted with any hung ordnance, live free fall, or externally mounted forward firing munitions aboard the aircraft. Hot refueling with TGM's or other captive, inert training missiles is permissible. External stores and the GAU-8 must be pinned and weapons switches OFF/SAFE. Hot refueling will not be conducted if any problems with inflight air refueling, fuel transfer or fuel venting have occurred. In the refueling area, minimum power will be used for taxi; radio transmissions and canopy repositioning are prohibited except in an emergency.

PRIOR TO HOT PIT ENTRY

1. AFTER LANDING checklist — Complete.
2. Dearming — Complete (as required).
3. APU generator/APU — Off.

PRIOR TO REFUELING

1. Canopy — As desired.

NOTE

- Canopy position is a pilot option. A closed canopy may provide fire protection; however, ground egress time will be increased and high ambient temperature may preclude this option. If an ejection capability is desired, canopy must be down and locked and pilot completely strapped in.

2. Strap-in connections — As desired (leave oxygen and communications leads connected).

NOTE

- Emergency ground egress time can be saved by disconnecting lap belt, shoulder harness, and survival kit attachments before refueling.

3. Fuel display selector — MAIN.

4. Brake and tire inspection — Complete.
5. Intercom with refueling supervisor — Establish.

DURING REFUELING

1. Monitor intercom and appropriate emergency response frequency.

WARNING

- Do not transmit on any radio except in an emergency.

NOTE

- Terminate refueling with a visual signal if intercom is lost.

2. Hands — In sight of ground crew.

WARNING

- In the event of a fire or fuel leak in the immediate vicinity of the aircraft while connected to the hydrant, shut down and ground egress. If a fire occurs outside the immediate vicinity of the aircraft, terminate refueling and taxi clear as directed by the ground crew.

AFTER REFUELING

1. Fuel quantity — Check.
2. Personal equipment leads — As required.
3. Taxi clear of refueling area and configure aircraft as required by mission plan.

94 TEMS STATUS CHECK (Figures 2-8 and 2-9)

1. External aircraft battery switch — ON.
2. UDU status switch — Press and hold.
 - a. UDU AIRCRAFT STATUS indicators — On.
 - b. UDU POWER INDICATOR — On.
 - c. UDU alpha numeric display — Four dot matrix segment goes on one at a time in sequence. Display continues until UDU status switch is released.
3. UDU status switch — Release.
 - a. UDU aircraft status indicators — One will remain on for approximately 5 seconds. Other than GREEN, note code in alpha numeric display and press UDU status switch again to check for other codes until the word DONE appears.
4. External aircraft battery switch — OFF.
5. See figure 2-9 for definition of alpha numeric codes.

UMBILICAL DISPLAY UNIT (UDU)

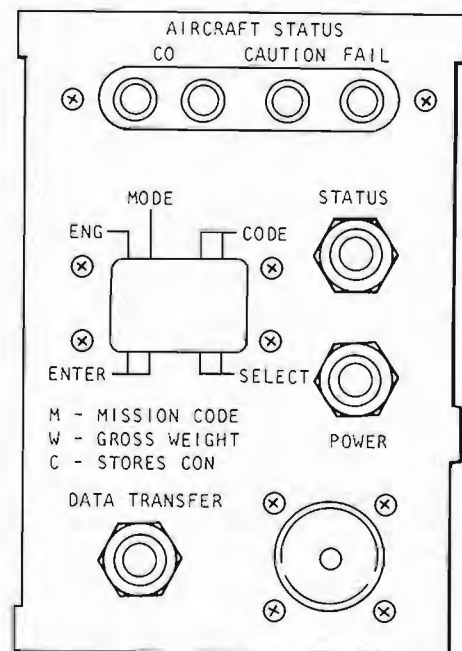
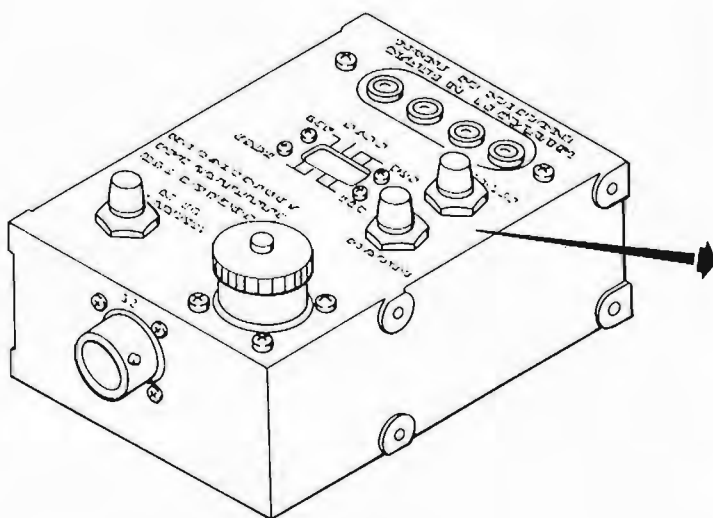

Figure 2-8

TEMS ALPHA NUMERIC CODES

Codes 1 - 14 indicate engine conditions critical to safety of flight.

- 01 ITT over 945°C or over 1000°C; fuel flow override normal
- 02 ITT over 945°C or over 1000°C; fuel flow in override
- 03 ITT over 900, 945, or 1000°C during START cycle
- 04 Core speed over 102%
- 05 Fan speed over 99.7%
- 06 More than one engine parameter fluctuating
- 07 Low oil pressure
- 08 Oil pressure fluctuating
- 09 Core speed vibration on more than one pickup
- 10 Fan speed vibration on more than one pickup
- 11 Inlet guide vanes OPEN off schedule
- 12 Flameout
- 13 Rollback
- 14 Low Power

Codes 26 - 44 indicate engine conditions not critical to safety of flight.

- 26 ITT 890°C; fuel flow override normal
- 27 ITT 890°C; fuel flow in override
- 28 Core speed over 99.4%
- 29 Fan speed over 98%
- 30 Fan speed over 94.5% on GROUND
- 31 ITT fluctuating
- 32 Core speed fluctuating
- 33 Fan speed fluctuating
- 34 Fuel flow fluctuating
- 35 High oil pressure
- 36 Core speed vibration on one pickup
- 37 Fan speed vibration on one pickup
- 38 Inlet guide vanes CLOSED off schedule
- 39 Idle speed low
- 40 ITT shift from normal
- 41 Stall
- 42 Stall (out of envelope)
- 43 Slow start
- 44 Fuel Filter differential pressure high

Codes 51 - 71 indicate status of TEMS system.

- | | |
|---|------------------------------|
| 51 EPU battery voltage low | 62 Fuel flow data invalid |
| 52 EPU failure | 63 Core speed data invalid |
| 53 T2C data invalid | 64 Fan speed data invalid |
| 54 PLA data invalid | 65 Oil pressure data invalid |
| 55 VG data invalid | 66 Vert G data invalid |
| 56 PS3 data invalid | 67 PTO data invalid |
| 57 PT5 data invalid | 68 PAMB data invalid |
| 58 Gearbox vibration data invalid | 69 AOA data invalid |
| 59 Front frame vibration data invalid | 70 TT2 data invalid |
| 60 Exhaust frame vibration data invalid | 71 PT5 vs PS3 data invalid |
| 61 ITT data invalid | |

Figure 2-9

SECTION III

EMERGENCY PROCEDURES

TABLE OF CONTENTS

GROUND OPERATION

EMERGENCIES	3-3
Engine/APU Fire	3-3
Engine Core Overtemp/Fuel Fails to Drain/Loss of Pneumatic Power	
During Engine Start	3-3
Engine Start Cycle Continues After Start	3-4
Engine Fails to Shut Down	3-4
Emergency Ground Egress	3-4
Canopy Malfunctions	3-5
Normal Brake/Anti-Skid Failure	3-5
Nosewheel Steering Malfunction	3-5

TAKEOFF EMERGENCIES	3-7
Abort	3-7
Single-Engine Failure or Fire During Takeoff (Too Late to Abort)	3-7
Tire Failure During Takeoff	3-8A
Landing Gear Retraction Failure	3-8B

INFLIGHT EMERGENCIES	3-9
Hydraulic Systems Malfunctions	3-9
Dual Hydraulic System Failure	3-9
Left/Right Hydraulic System Failure	3-9
Electrical Malfunctions	3-10
Battery Failure	3-10
Converter Failure	3-10
Electrical Failure—Total	3-10
Electrical Fire—Cockpit	3-13
Generator Failure	3-14
Inverter Failure	3-14
Fuel Systems Malfunctions	3-15
External Tank Jettison	3-15
Fuel Pressure Low	3-15
Fuel Quantity Indicator Malfunction	3-15
L-R Tanks Unequal	3-15
Main Boost Pump Failure	3-16

Wing Boost Pump Failure	3-17
Oxygen	3-17
Hypoxia	3-17
Smoke, Fumes, or Odors	3-17
Engine Malfunctions	3-18
Double-Engine Failure	3-18
Engine/APU Fire	3-20
Engine Failures/Overtemp	3-21
Engine Oil System Malfunction	3-22
Engine Start Cycle Light On	3-22A
ITT Control System Failure/Low Core RPM at MAX Power	3-22A
Single-Engine Restart	3-22A
Windmill Airstart	3-22B
General	3-24
APU Fluctuations/Overtemperature	
Overspeed	3-24
Bleed Air Leak/Service Air Overheat	3-24
Canopy — Loss of	3-24A
Canopy Unlocked Light On	3-24A
Canopy/Windshield Crack	3-24A
Cockpit — Loss of Pressurization	3-24A
Cockpit Overpressurization	3-24A
Cockpit Overtemperature	3-24A
Ditching	3-25
Ejection Procedures	3-25
Flameout Landing	3-30
Flap Asymmetry	3-32
Speed Brake Asymmetry or Fail to Close	3-32
Aileron/Elevator Control Jams	3-32
Failure to Shift into Manual Reversion	3-33
Failure to Shift Out of Manual Reversion	3-33
Out-of-Control Recovery	3-34
Pitch/Yaw SAS Disengagement	3-34
Uncommanded Pitch/Yaw Input	3-35
Trim Failure	3-35

TABLE OF CONTENTS (CONT)

<p>HARS Malfunction..... 3-35</p> <p>INS Failure..... 3-35</p> <p>Controllability/Structural Damage3-36</p> <p>LANDING EMERGENCIES 3-37</p> <p>Single-Engine Failure or Fire While Configured for Landing 3-37</p> <p>Stuck Throttle(s) Landing 3-39</p> <p>Single-Engine Landing..... 3-39</p> <p>Single-Engine Go-Around..... 3-41</p>	<p>Manual Reversion Landing 3-41</p> <p>Unsafe Gear Down Indication..... 3-42</p> <p>Landing Gear Alternate Extension 3-42</p> <p>Landing With Gear Not Down..... 3-42B</p> <p style="padding-left: 20px;">All Gear Up 3-42B</p> <p style="padding-left: 20px;">Nose Gear Safe, Both Mains Unsafe 3-42B</p> <p style="padding-left: 20px;">Nose Gear Safe, and One Main Gear Safe 3-42B</p> <p style="padding-left: 20px;">Nose Gear Unsafe, One or Both Mains Safe 3-42B</p> <p>Nosewheel Cocked..... 3-42C</p> <p>Blown Tire..... 3-42C</p>
---	--



READ AND HEED

INTRODUCTION

This section covers the operation of the aircraft during emergency/abnormal conditions. It includes discussions of problem indications and corrective actions as well as procedural steps when applicable. Adherence to these guidelines will ensure maximum safety for the pilot and/or aircraft.

The situations covered represent the most probable malfunctions. However, multiple emergencies, weather, or other factors may require modification of the recommended procedures. Accomplish only those steps required to correct or manage the problem.

When dealing with emergency/abnormal conditions, pilots must determine the most correct action using **SOUND JUDGMENT, COMMON SENSE, and FULL UNDERSTANDING OF APPLICABLE SYSTEMS.**

Critical emergency procedures are presented in **BOLDFACE** capital letters. Pilots shall be able to immediately accomplish these procedures in the published sequence without reference to the checklist.

Three basic rules apply to all emergency situations. These basic rules are not repeated in each of the procedures listed. However, in **ALL EMERGENCIES, THE OVERRIDING CONSIDERATIONS SHALL BE TO:**

1. Maintain aircraft control.
2. Analyze the situation.
3. Take proper action.

NOTE

- The ground, takeoff, and landing emergency procedures are sequenced as outlined in the Table of Contents.
- The inflight emergency procedures follow the HEFOE sequence with an additional listing of general inflight emergencies.
- Decision factors are provided as a guide in selecting certain procedures.

The terms "Land as soon as possible" and "Land as soon as practical" are used throughout this section. These terms are defined as follows:

Land as soon as possible — An emergency will be declared. A landing should be accomplished at the nearest suitable airfield, considering the severity of the emergency, weather conditions, field facilities,

ambient lighting, aircraft gross weight, and command guidance.

Land as soon as practical — Emergency conditions are less urgent, and although the mission is to be terminated, the degree of the emergency is such that an immediate landing at the nearest adequate airfield may not be necessary.

GROUND OPERATION EMERGENCIES

ENGINE/APU FIRE

An engine/APU fire is indicated by the engine/APU fire light coming on and/or visual indications of fire in the engine nacelle or APU area.

1. **THROTTLE/APU — OFF.**
2. **FIRE HANDLE — PULL.**
3. **AGENT — DISCHARGE.**

4. Perform EMERGENCY GROUND EGRESS, as required.

CAUTION

- If possible, one engine should remain running during braking to provide unlimited hydraulic power to either the normal or emergency brake system.

NOTE

- The design configuration of the A-10, with the engines mounted in nacelles external to the aft fuselage, is less subject to rapid spread of a catastrophic fire than internally mounted engines. The fire extinguishing system offers a high probability of controlling fire in the nacelle. Propagation of engine fire to the fuselage proper is restricted by a stainless steel firewall in the engine mount pylon. Differential pressure between the nacelle and the fuselage could allow heat or fire to transfer to the fuselage if the pylon firewall fails. The initial instrument indication to the pilot that the firewall has failed will probably be a BLEED AIR LEAK light. The canopy design allows the pilot to monitor the engine and nacelle section visually if fire indications persist.

ENGINE CORE OVERTEMP/FUEL FAILS TO DRAIN/LOSS OF PNEUMATIC POWER DURING ENGINE START

- An engine core overtemp exists whenever the ITT limitations in Section V are exceeded.
- Fuel normally drains from engine within 5 seconds after shutdown. A postshutdown overtemp is likely to occur if fuel fails to drain. An ITT indication above 540°C with the core rpm below 5% indicates an engine postshutdown overtemp.
- If loss of pneumatic power (APU, ground cart, or an operating engine) occurs during engine start, an engine overtemp may result, depending on engine rpm.

1. Throttle — Aft against OFF stop.

If ITT is not decreasing:

2. Establish an air source from:

a. APU.

b. Other engine (85% core rpm minimum) (pull emergency brake handle if required).

c. External ground cart.

3. Engine operate switch — MOTOR (until ITT below 150°C).

If ITT does not go below 200°C in 2 minutes:

4. Fire handle — PULL.

NOTE

- Engine core overtemp or tail pipe fire (reported by outside observer) will not normally cause the engine fire warning light to come on. Extinguishing agent will not put out an engine core fire, as it does not discharge into the core. Extinguishing agent should be used if the fire light comes on or if there are visual indications of an engine fire.

5. Perform EMERGENCY GROUND EGRESS.

GROUND OPERATION EMERGENCIES (CONT)

ENGINE START CYCLE CONTINUES AFTER START

If the ENG START CYCLE caution light remains on, or APU fails to unload within designated limits:

1. APU or external air source — Off.
2. Throttles — OFF.

ENGINE FAILS TO SHUT DOWN

If core rpm and ITT are maintained with throttle in OFF:

1. Fire handle (affected engine) — Pull.

NOTE

- Engine cannot be motored unless fire handle is pushed in or the appropriate BLEED AIR CONT circuit breaker is open.

EMERGENCY GROUND EGRESS

The method used to exit the aircraft will be determined by the circumstances of the emergency. A closed cockpit will provide a layer of protection from external fires or toxic fumes. When possible, the cockpit should not be opened until the pilot is free of all restraints.

WARNING

- Operating canopy electrical or canopy explosive jettison system when fuel fumes are present is not recommended.

1. Throttles, APU, and battery — OFF.
2. Seat — Safe.
3. Attachments — Release.
 - a. Shoulder harness — Release.
 - b. Lap belt — Release.
 - c. Survival kit straps — Release.

4. Canopy — Open (use appropriate method).

If time is critical:

- a. Canopy jettison handle — Pull.

WARNING

- The canopy may not jettison unless down and full forward.

Added see 135-70

If time is not critical:

- a. Canopy actuator disengage lever — Pull aft.

WARNING

- To avoid the possibility of being trapped in the cockpit during an emergency, the canopy actuator disengage lever should be pulled prior to attempting to open the canopy. This action allows the canopy to be opened manually if the actuator fails during the opening cycle.

- b. Canopy control switch — Open.
- c. Canopy — Raise manually.

WARNING

- If the canopy is disengaged and partially lifted manually, the canopy must not be opened electrically. Opening the canopy electrically after unseating the canopy actuator may cause damage, and the canopy may not be held up securely.
- d. Canopy breaker tool — Break hole in canopy.

Grasp the breaker tool in both hands with the sharp curved edge toward you. Strike perpendicular to the canopy surface with hard blows using blade alignment to set direction of cracks. Three or four blows will normally open an adequate escape hole.

- 5. Aircraft — Abandon. (Extend boarding ladder if desired)

Standing up in the aircraft will normally disconnect the remaining pilot service leads (communications, oxygen, and anti-g suit leads). Be sure all leads are disconnected before exiting the cockpit. Depress boarding ladder extension button, if desired.

GROUND OPERATION EMERGENCIES (CONT)

CANOPY MALFUNCTIONS

If canopy will not open:

1. Canopy actuator disengage lever — Pull aft.
2. Canopy control switch — Open.

If canopy still does not open:

3. Canopy — Raise manually.

If canopy is jammed partially open:

1. Emergency canopy actuator release lever — Actuate (located behind seat on aircraft right side).
2. Canopy — Raise manually.

NORMAL BRAKE/ANTI-SKID FAILURE

Use of emergency brakes will restore braking capability. If the right hydraulic system is pressurized, unlimited emergency braking is available. Otherwise, a minimum of five full emergency brake applications can be expected from the emergency accumulator, if pressurized.

1. Emergency brake handle — PULL (full aft).

CAUTION

- Release brake pedal pressure prior to selecting emergency brakes. Failure to re-

lease brake pedal pressure may cause the wheels to lock.

- Loss of braking can result from an electrical malfunction in the landing gear control valve circuitry. If this occurs, there will be no caution light or gauge indication, and normal brakes, anti-skid, and nosewheel steering will be inoperative.

NOTE

- Some anti-skid failures are not indicated by the anti-skid caution light.

NOSEWHEEL STEERING MALFUNCTION

If nosewheel vibration, shimmy, or control problems are experienced:

1. Stop the aircraft.

CAUTION

- Nosewheel steering loss may be an indication of normal brake failure.

NOTE

- Shimmy may be reduced by increasing weight on the nosewheel and reducing speed.

TAKEOFF EMERGENCIES

ABORT

During an abort the speed brakes can be opened to 100%, and will remain fully open down to zero airspeed after losing the right engine. The loss of speed brakes in this instance would be a second order failure of the hydraulic system, due to either a rapid fluid loss or catastrophic engine failure (seized engine). Speed brake failure during an abort can be considered to have an extremely remote probability of occurrence.

1. Throttles — IDLE.
2. Speed brakes — OPEN.

If an engine failure, fire, or overtemp is indicated:

3. Throttle(s) [malfunctioning engine(s)] — OFF.

CAUTION

- On **8** and **45**, if the throttle is left in IDLE, ignition will be initiated when core rpm decreases below 56%. This could cause engine core overtemp.

4. Emergency brake handle — Pull [if left/both engine(s) shut down].

WARNING

- The main gear may not retract if the down lock override system is used with weight on the struts. This method of stopping the aircraft is not recommended.

CAUTION

- If the left engine is inoperative, nosewheel steering, normal braking, and anti-skid are not available. In this case, the emergency brake handle must be pulled to obtain brakes. If both engines are shut down or failed, at least five full brake applications should be available.

- Maximum performance braking may cause hot brakes, depending upon aircraft speed and gross weight. If hot brakes are suspected, park aircraft in uncongested area until cooling is accomplished. (See figure 5-2 for wheel brake energy limits.)

NOTE

- If it is apparent that the aircraft is going to run off the runway, it may be desirable to jettison stores.
- The effects of an MA-1 barrier engagement are unknown. However, if an MA-1 is the only thing between stopping or running off a prepared surface, taking the barrier would be the best alternative.

5. Perform ground ENGINE FIRE procedure, if applicable.

SINGLE-ENGINE FAILURE OR FIRE DURING TAKEOFF (TOO LATE TO ABORT)

If an engine failure or fire occurs during takeoff, the pilot must immediately decide whether to continue the takeoff or to abort. Below 70 KIAS, flight control inputs may be inadequate to maintain control of the aircraft with one engine at MAX and the other engine failed. In this case, an abort is the only option. Above continuation speed (minimum go-speed) but below refusal speed, it is possible to continue the takeoff. However, an abort is normally the preferable option. If an abort is not possible, both throttles should remain at MAX until a safe altitude is attained. Gear retraction should be accomplished promptly once safely airborne in order to enhance performance and to take advantage of any residual hydraulic pressure. If the aircraft does not have a positive gear down, single-engine rate-of-climb potential, it may be possible to retract the landing gear by residual hydraulic pressure if the gear handle is raised within 5 seconds after left engine failure. A catastrophic engine failure (seized engine), or a rapid loss of left hydraulic fluid could preclude raising the gear, but this has a remote probability of occurrence. Jettison of heavyweight stores will significantly improve climb performance. Fully retracting the flaps will

TAKEOFF EMERGENCIES (CONT)

increase single-engine climb performance but will also decrease stall margin at low airspeed. Therefore, if climb performance allows, full retraction should be delayed until above 150 KIAS. A near level attitude should be maintained while accelerating to a minimum of best single-engine climb speed. Accelerate and climb straight ahead if terrain permits. If turns are necessary, they should be made into the good engine, if possible, and at minimum practical bank angle.

1. RUDDER — CONTROL YAW.

WARNING

- During single-engine operation, failure to use sufficient rudder can result in large sideslip angles and yaw rates. It is possible to create a condition where the yaw rate becomes so high that there is insufficient rudder available to correct it, and the aircraft will depart controlled flight.

NOTE

- Following engine failure, the associated rudder will revert to manual control when hydraulic pressure bleeds off. Total rudder effectiveness is slightly degraded and pedal force requirements are noticeably higher.
- In visual meteorological conditions, yaw control is best accomplished by using rudder to stop any nose excursions relative to outside visual cues. In instrument meteorological conditions, the pilot must use cockpit instruments (turn needle — centered and heading — stabilized) to determine when sufficient rudder is being applied.

2. THROTTLES — MAX.

WARNING

- On [8] and [45], if the throttle of the bad engine is retarded to IDLE, crossbleed air from the good engine will be initiated when core rpm decreases below 56%, resulting in a 4% thrust loss.

3. GEAR — UP.

4. STORES — JETTISON IF REQUIRED ■

WARNING

- The external 600-gallon fuel tanks are directionally destabilizing. Close pilot attention will be required to avoid rapid increases in sideslip. External tank jettison is highly recommended for both performance and handling considerations.
- Engine failure after takeoff prior to gear retraction with high runway temperature/pressure altitude may result in the aircraft being unable to accelerate to single-engine climb speed. With gear up, minimal acceleration rate, low altitude, and terrain features may not allow for sufficient time of flight to safely recover the aircraft.
- Nonjettisonable ECM pods on outboard stations will contribute to directional control problems if a counter balancing store on the opposite wing is jettisoned. This will be particularly evident if the ECM pod is in the same side as the failed engine. The overriding consideration must be aircraft performance. If single-engine climb capability is questionable, jettison is the only alternative.

NOTE

- Best single-engine performance is achieved with a slight bank (up to 5°) into the good engine and rudder, as required, to maintain a constant heading. The ball will be displaced toward the good engine, proportional to the amount of bank used.

TAKEOFF EMERGENCIES (CONT)

At safe altitude and with airspeed above 150 KIAS (if possible):

5. Flaps — UP (EMER RETR if necessary).

WARNING

- If left hydraulic pressure is not available, the pilot must select EMER RETR. Use extreme caution to ensure the manual reversion switch is not inadvertently activated.

CAUTION

- During emergency situations, operation of the engine with the ENG FUEL FLOW switches in OVERRIDE will provide 15-20% more engine thrust. Operation of the engine in override should only be accomplished for the minimum time to achieve safe operating conditions. ITT should be reduced below 865°C for -100A engines and 830°C for -100 engines as soon as minimum safe altitude and rate of climb are achieved (estimate one to three minutes).
- Additional rudder input and bank will be required to control yaw when selecting OVERRIDE. The pilot should also anticipate an ENG HOT light illuminated and high ITT on the properly functioning engine.
- Operation for several minutes in OVERRIDE will not precipitate an immediate engine failure. However, ITT can reach 980°C and some engine durability degradation will occur. Operation in OVERRIDE for more than 15 minutes is not recommended.

- Engineering analysis determined that the aircraft will be controllable during single engine operations with T5 override. With an ECM pod on the same side as the nonoperating engine, approximately 40% rudder travel is still available for maneuvering the aircraft.

NOTE

- Best single-engine climb speed is a function of temperature, pressure altitude, gross weight, and configuration/drag index. As a rule of thumb for engine failure on takeoff, best single-engine climb speed is 10 KIAS above computed takeoff speed in the normal takeoff configuration (gear down, flaps 7°). From this baseline, best single-engine climb speed increases 10 KIAS with the gear retracted and another 10 KIAS when the flaps are fully retracted. Due to high rudder force requirements and increased yaw departure potential at low airspeeds, the pilot should attempt to maintain a climb speed in excess of 150 KIAS if possible. If a best single-engine climb speed below 150 KIAS must be maintained, it is essential that yaw rate be controlled through proper use of rudder and bank into the good engine. This will increase climb potential, as well as reducing the possibility of a yaw departure.

6. Accomplish ENGINE FAILURES/OVERTEMP or ENGINE FIRE procedure, as required.

TIRE FAILURE DURING TAKEOFF

If takeoff aborted:

1. Anti-skid — OFF (blown main).
2. Use rudder, nosewheel steering, and brakes to maintain directional control.

TAKEOFF EMERGENCIES (CONT)

If takeoff continued:

1. Do not retract gear or flaps.
2. Refer to BLOWN TIRE procedure.

LANDING GEAR RETRACTION FAILURE

If the warning light in the landing gear handle remains on after the handle has been moved to UP, or there is other indication of gear retraction failure:

1. Airspeed — Maintain below 200 KIAS.

2. Landing gear handle — DOWN.

NOTE

- If the landing gear cannot be raised, it could indicate an electrical malfunction in the landing gear control valve circuitry. If this is the case, the landing gear circuit breaker may or may not be open. The landing gear circuit breaker should be reset if possible. Use caution on landing, as normal brakes, anti-skid, and nosewheel steering may not be available. Emergency braking can be obtained by pulling the emergency brake handle.

3. LAND GEAR circuit breaker — Check closed.
4. AUX LG EXT handle -- Check closed.

INFLIGHT EMERGENCIES

HYDRAULIC SYSTEMS MALFUNCTIONS

Adequate flight control system response will be available with either the left or right hydraulic system operating.

NOTE

- With one hydraulic system out, rudder forces will be higher than normal, and total rudder authority will be reduced. Crosswind landing will require a higher pilot workload.

DUAL HYDRAULIC SYSTEM FAILURE

WARNING

- With flaps full down, maintaining level flight following transition to manual reversion may require aft stick forces that exceed the physical capability of the pilot. If transition to MRFCs occurs with flaps full down, it is imperative that the flap emergency retract switch be activated immediately.

On indication of impending failure, regain 1g level flight at moderate speed.

At failure:

1. Flight controls — MAN REVERSION.

NOTE

- Restrain stick to lateral neutral while actuating flight control mode switch.

Four seconds after hydraulic pressure supply bleed off, the aircraft should be in full manual reversion mode.

Prior to landing:

2. Refer to MANUAL REVERSION LANDING Procedure.

LEFT/RIGHT HYDRAULIC SYSTEM FAILURE

If the left hydraulic system fails, the following systems will be inoperative: flaps, nosewheel steering, normal landing gear operation, normal wheel brakes, and anti-skid. Additionally, the left elevator and rudder actuators will be inoperable hydraulically and dual channel pitch and yaw SAS will be nonfunctional.

If the right hydraulic system fails, the following systems will be inoperative: slats, slipway door (normal operation), air refueling nozzle latch rollers, and speed brakes. The auxiliary landing gear accumulator and the emergency brake accumulator will not be recharged. The slats will extend and the drag index will increase. Additionally, the right elevator and rudder actuators will be inoperable hydraulically and dual channel pitch and yaw SAS will be nonfunctional.

The L/R-HYD RES caution light comes on to indicate loss of hydraulic fluid. If hydraulic fluid continues to leak, the L/R-HYD PRESS caution light will come on, at which time left/right system hydraulic pressure will be lost. If a leak in the flap or speed brake hydraulic lines is suspected, selecting EMER RETR for the affected system may prevent depletion of the associated hydraulic fluid supply. Since the landing gear are pressurized while down, depletion of left hydraulic pressure due to a leak in the landing gear (or associated systems) hydraulic lines can be prevented by pulling the LAND GEAR circuit breaker.

1. FLAP EMER RETR and/or SPD BK EMER RETR — EMER RETR.

If pressure decreases:

2. SAS/Anti-skid — Paddle OFF.
3. Pitch SAS — Leave OFF.
4. Yaw SAS switch (operable channel only) — Engage (if desired).
5. Anti-skid switch — ANTI-SKID (if left hydraulic system is operable).
6. Monitor hydraulic pressure of operable hydraulic system and land as soon as practical.

INFLIGHT EMERGENCIES (CONT)

Prior to landing:

7. Landing gear handle — DOWN.

If left hydraulic system has failed or LAND GEAR circuit breaker was pulled:

8. AUX LG EXT handle — Pull.
9. AUX LG EXT handle — Push in (when landing gear indicates safe).
10. Emergency brake handle — Pull.

If both hydraulic systems fail: refer to DUAL HYDRAULIC SYSTEM procedure.

ELECTRICAL MALFUNCTIONS

See figure 3-1 for busses and systems lost due to an electrical power supply system failure.

BATTERY FAILURE

Caution light panel legends on: None.

In the event of battery failure caused by "thermal runaway," or an internal short as differentiated from a depleted battery, the overloads placed upon the converters cause the converter circuit breakers to open. This results in complete loss of DC power recognizable by loss of all warning lights and communications. If it is assumed that the main generators are operational. Use the following procedure to restore DC power:

1. Battery switch — OFF.
2. CONVERTER L circuit breaker — Close.

The left converter will now power the entire DC system. Leave battery switch in OFF.

3. Land as soon as practical.

CONVERTER FAILURE

Caution light panel legends on: L-CONV and/or R-CONV.

If only one converter is failed, the operational converter will assume the DC load. With both converters failed, the battery is the remaining source of DC, and will automatically power the DC essential and auxiliary DC essential busses.

NOTE

- Battery life is a function of its condition and state-of-charge, and should last for approximately 60 minutes. If the generators are not supplying AC, battery life will be reduced to 18 minutes unless the inverter is turned off.

1. CONVERTER L and AUX ESS BUS TIE circuit breakers — Check closed.

If both converters have failed:

2. Land as soon as possible.

ELECTRICAL FAILURE — TOTAL

Caution light panel legends on: None.

Total electrical failure is defined as loss of generators and failure or complete discharge of the battery. Electrical failure is indicated by loss of all electrical instruments except core rpm, off flags in electrically powered instruments, loss of communications/side tones, and loss of all electrically controlled or actuated systems. Engine start, APU, normal landing gear extension and its indication, flaps, speed brakes, normal brakes, trim, SAS, and the ability to transition to or from MRFCS will not be available.

All data on page 3-10A/(3-10B blank) deleted.

ELECTRICAL POWER SUPPLY SYSTEM FAILURE CHART

ELECTRICAL SYSTEMS LOST

BOTH GENERATORS

BUSSES LOST

LEFT/RIGHT AC BUS
LEFT/RIGHT DC BUS
AC/DC ARMAMENT BUS

BOTH CONVERTERS

LEFT/RIGHT DC BUS
DC ARMAMENT BUS

LEFT AC BUS SYSTEMS LOST

RADAR WARNING
BOOST PUMPS - L MAIN AND L WING
LIGHTS: AUX INST, CONSOLES, FORMATION, LANDING/TAXI
PITOT HEAT*
WINDSHIELD DEFOG/DEICE

LEFT DC BUS SYSTEMS LOST

AIR REFUEL
AN ALR-69 RADAR WARNING
LIGHTS: ANTI-COLLISION, THUNDERSTORM
RAIN REMOVAL/WINDSHIELD WASH

RIGHT AC BUS SYSTEMS LOST

AOA HEATER
BOOST PUMPS - R MAIN AND R WING
FUEL FLOW INDICATOR
HARS
IFF MODE 4
LANDING LIGHT
PITOT HEAT*
SAS
SPS
TACAN
INS (CDU AND INU) 62
CADC 62
MBC 62

RIGHT DC BUS SYSTEMS LOST

AOA INDICATOR, INDEXER, AND STICK SHAKER
UHF ADF
VHF:AM
VHF:FM
FLAP CONTROL
KY-28 SECURE COMM
LIGHTS POSITION
NAV MODE SELECT
ILS 47
SAS
SPS
TACAN
INS (CDU AND INU) 62
CADC 62

AC ARMAMENT BUS SYSTEMS LOST

GUN CAMERA 68 99
HUD
MASTER ARM
TISL
TV MONITOR
CTVS 69 98

DC ARMAMENT BUS SYSTEMS LOST

GUN FIRING AND CAMERA 68 99
HUD
MASTER ARM
TISL
AVTR 69 98

* THE PITOT-STATIC HEATER IS POWERED BY THE LEFT AC BUS WITH A BACKUP POWER SUPPLY PROVIDED BY THE RIGHT AC BUS.

Figure 3-1.

INFLIGHT EMERGENCIES (CONT)

The following systems should be available following complete electrical failure:

- Accelerometer
- Air refueling (stiff boom)
- Anti-g system
- Auxiliary gear extension
- Canopy jettison
- Clock
- Core rpm indication
- ECS (fails to NORM or RAM, as set before failure)
- Ejection seat
- Emergency braking
- Gravity fuel feed
- Manual canopy opening
- Normal flight controls (without SAS or trim)
- Nosewheel shimmy damping
- Oxygen (normal and emergency)
- Pitot-static instruments
- SAI ($\pm 6^\circ$ for 9 minutes following electrical failure)
- Slip indicator
- Standby compass
- Throttles (engine speed control without ITT or pressure limiters)

The following procedure applies to flight and landing following total electrical failure:

1. Throttles — Retard (maintain core speeds below 90% when at or below 25,000 feet MSL or below 85% if above 25,000 feet MSL).

NOTE

- SAI is reliable within $\pm 6^\circ$ for a minimum of 9 minutes after the battery switch is OFF.
- 2. Descend to 10,000 feet MSL or below, if possible. If not possible, maintain altitude below 20,000 feet MSL.

WARNING

- Cockpit indication of fuel status will not be available. Timing and estimated fuel flow must be used to determine quantity remaining. Fuel in external tanks will not feed, and the tanks cannot be jettisoned.

Prior to landing:

3. Plan no flap/no speed brake approach.
4. Extend landing gear.
 - a. Landing gear handle — DOWN.
 - b. AUX LG EXT handle — Pull.
5. Emergency brake handle — Pull.

NOTE

- There will be no cockpit indication of landing gear down and locked. The pilot must rely on sound and feel or visual checks to determine gear position. It may take up to 30 seconds for the gear to extend and lock.

c. AUX LG EXT handle — Push in.

CAUTION

- Anti-skid protection will not be available. If locked wheel(s) and/or skidding are detected, release brakes and reapply cautiously.

NOTE

- Electrical canopy actuation and boarding ladder extension will be inoperative. The pilot must use the canopy actuator disengage lever and manually raise the canopy. If time is critical, emergency canopy jettison can be used.

INFLIGHT EMERGENCIES (CONT)

ELECTRICAL FIRE—COCKPIT

Smoke or odors from burning insulation in the cockpit may be indicative of electrical or an engine/air conditioning system malfunction. Therefore, this procedure should be used only when there is evidence that the cause is an electrical fault or malfunction.

1. Oxygen — 100%.
2. Temperature pressure control — RAM.
3. Crossfeed switch — CROSSFEED.
4. Generator switches (L & R) — OFF/RESET.

WARNING

- Placing the L and R generator switches to OFF/RESET will result in shutoff of all fuel pumps except the DC fuel pump in the left main tank. Placing the battery switch to OFF will shut off the DC fuel pump. The maximum altitude for suction-feed is affected by engine power setting, throttle movements, fuel temperature, and aircraft maneuvers. Although engines have operated successfully under ideal conditions at altitudes above 20,000 feet, consideration should be given to maintaining a lower altitude. Below 10,000 feet, suction-feed will be adequate for all operating conditions.
5. APU switch — OFF.
 6. Emergency floodlights switch — EMER FLOOD (if required).
 7. Throttles — Retard until engine core speed starts to decrease.

NOTE

- Retarding the throttles should prevent engine overtemperature, unless a climb is

made to a significantly higher altitude.

Turning off the inverter will result in engine fuel flow override operation (no ITT limiter) and loss of engine temperature indication. The engine core speed indicator is independent of the aircraft electrical system except for lighting.

8. Inverter switch — OFF. (Maintain core speeds below 90% when at or below 25,000 feet MSL or below 85% if above 25,000 feet MSL.)

9. Battery switch — OFF.

NOTE

- SAI is reliable within $\pm 6^\circ$ for a minimum of 9 minutes after battery switch is OFF.

10. All electrical equipment — OFF.

In the following steps, restore power sources one at a time after the fire is out only to the extent necessary to restore minimum essential electrical equipment to continue to a safe landing. If the fire reoccurs when the battery switch is turned on, it may be possible to isolate the malfunctioning component using cockpit circuit breakers.

11. Battery switch — PWR.

If power can be restored:

12. Inverter switch — STBY.

13. Respective generator switches — PWR.

14. Turn on essential electrical equipment, one at a time.

15. Crossfeed switch — As required.

If power cannot be restored:

12. Refer to ELECTRICAL FAILURE-TOTAL procedure.

INFLIGHT EMERGENCIES (CONT)

GENERATOR FAILURE

Caution light panel legends on: L and/or R GEN.

In addition, with both generators failed: L and R CONV, L and R MAIN PUMP, L and R WING PUMP, R FUEL PRESS, PITCH SAS, YAW SAS, and WINDSHIELD HOT.

With one generator failed, the remaining generator should automatically assume and support the AC power requirements.

CAUTION

- If the left generator fails and bus power fails to transfer, a temporary loss of the ITT amplifiers may result in double engine overtemp with throttles in the MAX range.

NOTE

- Battery life is a function of its condition and state-of-charge at instant of second generator failure. For example, at 90% charge it should last approximately 18 minutes. If instruments are not required, shutting off the instrument inverter will extend battery life to approximately 60 minutes. This time may be extended indefinitely by switching the battery OFF until absolutely essential to use.
1. GENERATOR CONT circuit breaker(s) — Check closed.
 2. Failed generator switch(es) — OFF/RESET momentarily, then to PWR.
 3. If generator(s) will not reset after 3 attempts — Generator switch(es) to OFF/RESET.

4. APU — START (below 15,000 feet MSL).
5. APU generator switch — PWR.

NOTE

- In an emergency, the APU generator can be used to supply essential equipment indefinitely.
6. Land as soon as practical.

INVERTER FAILURE (NO POWER AVAILABLE TO AC ESSENTIAL BUSES)

In the event of loss of both generators and the instrument inverter fails to automatically come on the line or fails subsequently, the INST INV and L and R ENG HOT caution lights will come on.

1. Throttle(s) — Retard. (Maintain core speeds below 90% when at or below 25,000 feet MSL or below 85% if above 25,000 feet MSL.)

CAUTION

- Severe engine overtemp is possible due to loss of ITT amplifiers.
2. Circuit breakers — Check closed.
 3. Inverter switch — Recycle STBY to TEST, and back to STBY several cycles. Leave in STBY.
 4. APU — START (below 15,000 feet MSL).
 5. APU generator switch — PWR.
 6. Land as soon as practical.

INFLIGHT EMERGENCIES (CONT)

FUEL SYSTEMS MALFUNCTIONS

EXTERNAL TANK JETTISON

If it becomes necessary to selectively jettison external tanks because of one tank being damaged, the following procedure is recommended:

1. Landing gear handle — UP.
2. Flap lever — UP.
3. Fuel tank station — Select.
4. Selective jettison switch — STORE.
5. Master arm switch — ARM.
6. PUSH-TO-JETT switch — Depress.
7. Master arm switch — SAFE.

FUEL PRESSURE LOW

Indicated by the L-FUEL PRESS or R-FUEL PRESS caution lights coming on.

1. Crossfeed switch — CROSSFEED. Light goes off indicating boost pump failure.

If L/R FUEL PRESS light stays on, indicating possible leak or pressure sensor malfunction:

2. Crossfeed switch — OFF.
3. Monitor fuel status to determine if leak exists.

If an external fuel leak exists, indicated by excessive fuel quantity drop, vapor trail and/or verification by other aircraft:

4. Throttle (affected engine) — OFF.
5. Fire handle (affected engine) — PULL.
6. SAS switches — OFF.

7. YAW SAS switch (operable channel only) — Engage (if desired).

8. Crossfeed switch — CROSSFEED (if fuel leak has definitely stopped).

9. Perform SINGLE-ENGINE LANDING procedure.

WARNING

- Due to the possibility of explosion, do not start the APU following engine shutdown for a fuel leak.

FUEL QUANTITY INDICATOR MALFUNCTION/MAIN FUEL LOW L/R

In the event of fuel quantity indicator malfunctions, the pilot should monitor fuel flow and flight time and land when practical. The L and R MAIN FUEL LOW caution lights are independent of the quantity measuring system, and should not be affected by a malfunction of the quantity indicating system.

1. Crossfeed switch — CROSSFEED (unless fuel leak is suspected).

The fuel remaining in each tank after the L or R MAIN FUEL LOW caution light comes on is sufficient to fly 20 minutes at maximum range cruise power and altitude, plus fuel for a normal descent and landing plus one missed approach. When operating with the L or R MAIN FUEL LOW light on, maintain a cruise attitude and avoid abrupt maneuvers that will cause fuel sloshing in the tanks.

L-R TANKS UNEQUAL

The L-R TKS UNEQUAL caution light comes on at a 750(±250) pound differential between the main fuel tanks. The pilot must determine the cause of the fuel differential and use differential throttles, boost pump switches, or the tank gate switch as necessary to maintain internal fuel at the desired level. The aircraft cg will remain within limits if the left main (aft) tank fuel level is not allowed to exceed the right main (forward) tank level by more than 1,000 pounds.

INFLIGHT EMERGENCIES (CONT)

If the L-R TKS UNEQUAL caution light comes on, or fuel imbalance is noted, equalize the main tank fuel levels as follows:

1. Crossfeed switch — CROSSFEED.
2. Wing boost pump switches — OFF.

If the right system has the lesser amount of fuel:

3. Right main boost pump switch — OFF.

If the left system has the lesser amount of fuel:

3. Left main boost pump switch -- OFF;
DC FUEL PUMP circuit breaker -- Open.

When the imbalance has been corrected:

4. Main boost pump switch — L or R MAIN.
5. Wing boost pump switches — L and R WING.
6. DC FUEL PUMP circuit breaker — Close.
7. Crossfeed switch — OFF.

Conditions permitting, the tank gate switch may be used; however, the fuel balance must be closely monitored.

WARNING

- Returning the crossfeed switch to OFF prior to turning the main boost pump on may result in an engine flameout.
- If the tank gate switch has been activated, do not hot refuel until it can be verified by ground test that the tank gate valve is closed.

If the imbalance cannot be corrected or gauge malfunction is suspected:

4. CROSSFEED switch — CROSSFEED.
5. Main boost pump switches — L and R MAIN.
6. Wing boost pump switches — L and R WING.
7. DC FUEL PUMP circuit breaker — Close.

MAIN BOOST PUMP FAILURE

Failure of either main fuselage boost pumps indicated by the applicable L or R MAIN PUMP caution light coming on will have no effect on engine operation while fuel is being pressure fed from the wing tanks. When the wing tank boost pumps are not operating, fuel will suction-feed from the main tanks to an altitude of approximately 10,000 feet. Above this altitude engine operation could become erratic; however, placing the crossfeed switch to CROSSFEED will supply the engines with fuel under pressure from any operating boost pump and allow continued operation above 10,000 feet. Fuel quantity must be monitored to maintain cg within limits and preclude fuel exhaustion.

1. Crossfeed switch — CROSSFEED.

The tank gate switch will equalize the main tanks in straight and level flight and may be used to accomplish fuel transfer if desired. Fuel transfer from the left (aft) tank to the right (forward) tank may be expedited by lowering the nose and allowing the tank fuel to gravity flow to the forward tank. Climbing with the tank gate switch in open position will expedite gravity fuel flow to the aft tank. To ensure that the aircraft cg remains within established limits, the aft tank fuel should not exceed the forward tank fuel by more than 1,000 pounds.

2. Tank gate switch — As required.

INFLIGHT EMERGENCIES (CONT)

WING BOOST PUMP FAILURE

If the L or R WING PUMP caution light comes on the remaining fuel in the affected tank will not gravity transfer until the fuel level in that fuselage tank is below 600 pounds. If the pilot takes no action, a maximum difference of approximately 2,000 pounds JP-4 (total left or right wing tank fuel) could exist between main tanks. If the right wing boost pump fails, this will place the aircraft in the aft cg condition that is at or beyond limits, and impose airspeed limits on operations (see Section V, Flight Restrictions with Fuel Imbalance). Failure of the left wing boost pump will cause the left (aft) fuselage tank to feed while the right (forward) tank remains full (during pressurized feed of the right wing tank). CG shift will be forward within allowable limits.

If either L or R WING PUMP caution light comes on, the pilot will be required to take the following actions to minimize CG travel.

1. Crossfeed switch -- CROSSFEED.

The higher pressure (+5 psi minimum) of the wing boost pump overrides the main fuselage pump pressure, and will cause the operating wing fuel tank to empty. If the demand of both engines lowers the operating wing boost pump pressure, the added fuel required will be supplied by the main boost pumps. When the wing fuel stops feeding, as evidenced by fuel gauge readings:

2. Crossfeed switch -- OFF.

Fuel will then feed from each fuel tank to its respective engine in the normal manner.

CAUTION

- Applicable wing fuel may not be recoverable with a failed boost pump.

Straight and level flight with a minimum of abrupt maneuvers will maximize the amount of wing fuel available by gravity to the main tanks.

OXYGEN

HYPOXIA

If hypoxia is suspected:

1. Oxygen supply lever -- ON.
2. Oxygen -- 100%.
3. Oxygen emergency lever -- EMERGENCY.
4. Oxygen flow indicator -- Check blinking.
5. Oxygen supply pressure -- Check above 55 psi.

If malfunction confirmed:

6. Activate emergency oxygen supply.
7. Descend to 10,000 feet MSL or below if possible.

SMOKE, FUMES, OR ODORS

Smoke/Fumes/Odors can cause some measure of pilot incapacitation that can degrade a pilots ability to exercise proper judgement.

1. Oxygen -- 100%.
2. Check for fire. (If electrical fire exists, refer to ELECTRICAL FIRE -- COCKPIT.)
3. APU switch -- OFF.
4. (CONDITIONS PERMITTING) Descend to 25,000 ft MSL or below.
5. TEMP/PRESS control -- RAM.
6. CANOPY DEFOG control -- OFF.

If smoke, fumes, or odors continue:

7. BLEED AIR switch -- OFF.

If smoke is still entering from air conditioning system:

8. MAIN AIR SUPPLY switch -- OFF.

If smoke becomes severe:

9. Canopy -- Jettison.

INFLIGHT EMERGENCIES (CONT)

ENGINE MALFUNCTIONS

DOUBLE-ENGINE FAILURE

It takes approximately 90 seconds to regain usable engine power after initiation of the APU start and subsequent engine start. At low altitude, a 30,000 pound A-10 flown at best glide speed will descend approximately 3,000 feet in 90 seconds. Consequently, during takeoff, landing, and certain low airspeed/low altitude cruise situations, it is impossible to accomplish an engine start prior to ground impact. An early decision to eject is imperative. If possible, ejection should be accomplished in a wings level climb. However, in some cases it will not be possible to attempt a climb without risking a stall. In some cruise situations, even at low altitude, there will be potential for an engine restart. The aircraft will either already be at an adequate starting altitude or can be zoomed to exchange airspeed for altitude. The pilot must evaluate the situation and determine whether a restart, ejection, or flameout landing is the proper course of action. (See figure 3-2 for determining maximum glide distance with both engines windmilling.) If the APU is running when engine failure occurs, restart time will be reduced by 30 - 40 seconds. If both engines fail during flight at high altitude (above 20,000 feet MSL), the pilot must make a decision to trade altitude for airspeed to try a windmill start using the WINDMILL AIRSTART procedure, and/or to glide down to a lower altitude to start the APU for an assisted start. If attempts to start the APU fail, then a windmill start is the pilot's only option for an engine start.

1. THROTTLES — OFF.

NOTE

- If rapid cooldown is not observed within 5 seconds of shutdown, ensure that the affected throttles are positioned against the aft/OFF stop to shut off all fuel flow and permit engine cooling.

2. APU — START.

NOTE

- The APU is designed to start at altitudes up to 15,000 feet. However, the APU has been started at altitudes up to 20,000 feet.
- APU generator should be turned on after the APU comes up to speed to provide electrical power for hydraulic pump cooling.

3. FLIGHT CONTROLS — MAN REVERSION.

WARNING

- In certain situations flight into the engine disturbance area (see figure 6-2) with the throttles in idle may cause the engines to stagnate at idle core RPM without engine overtemp. This condition will not cause a Master Caution Light and the best course of action may be to leave the flight controls in NORMAL utilizing available hydraulics, while performing a single engine restart.

NOTE

- It will normally take 4 seconds after the flight control mode switch is set to MAN REVERSION before the aircraft is in full manual reversion mode. Expect a pitch transient at transition. During this time, only rudder is available for roll control (rudder and elevator are available immediately).

4. LEFT ENGINE — MOTOR.

CAUTION

- Cool engine until the ITT is below 150°C. Attempting restart with ITT above 150°C will result in overtemp and may damage the engine to the extent that usable power will not be available.

Reflects TO 1A-10A-1SS-73 dated 30 September 1988.

BEST GLIDE — BOTH ENGINES WINDMILLING

FLIGHT CONTROL MODE SWITCH-MAN REVERSION

NO WIND, CLEAN + 11 PYLONS

NO SPEED BRAKES FLAPS UP

BEST GLIDE SPEED AT 30,000 LB: 140 KIAS
 ADD (OR SUBTRACT) 2 KTS/1,000 LB ABOVE
 (OR BELOW) 30,000 LBS.

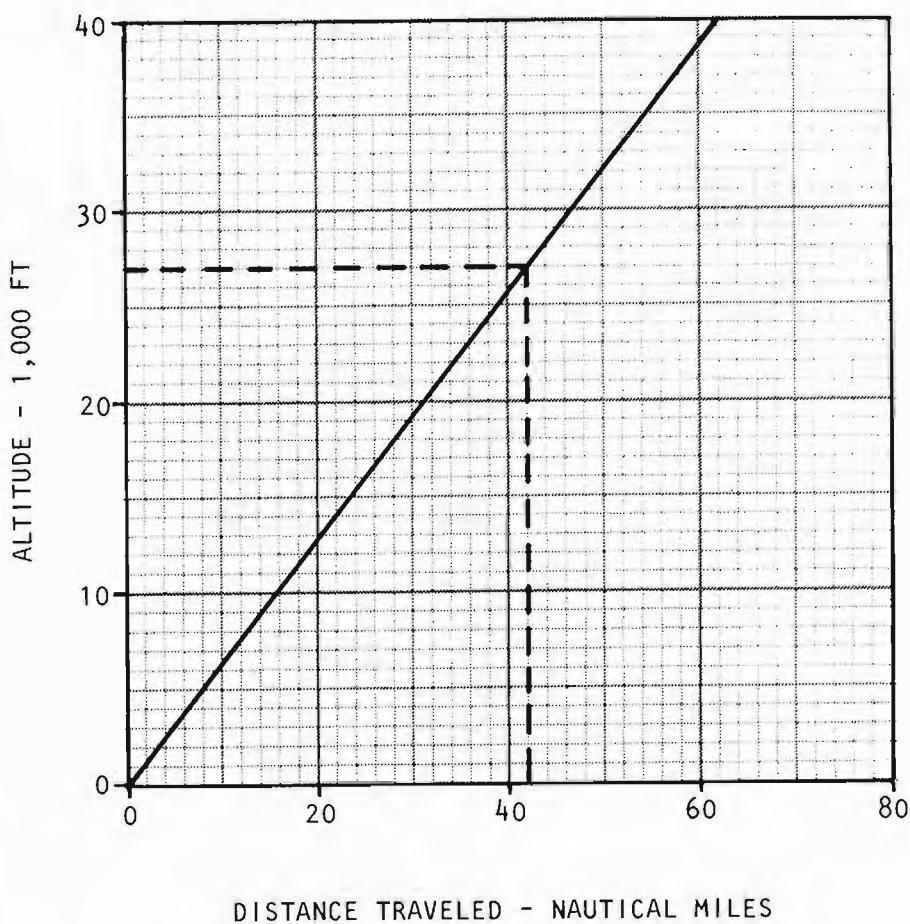

1-10A-3-5

Figure 3-2.

INFLIGHT EMERGENCIES (CONT)

5. LEFT ENGINE — START. (ITT rise within 20 seconds.)

WARNING

- Actuation of the ignition sequence between the time the APU switch is moved to START and the APU rpm reaches 60% may preclude ignition signals from reaching the engine. If ignition does not occur, stop the ignition attempt and reinitiate the ignition sequence after the APU rpm has reached 60% or greater.

CAUTION

- The throttle must be position against IDLE stop in order to obtain APU assisted engine starts. If the throttle is moved forward of IDLE, the ATS control valve will close and ignition is terminated after 30 seconds. On [1], the applicable ignition button must be depressed to obtain ignition on all starts.

NOTE

- The APU is designed to provide adequate air pressure and flow for engine starting at altitudes up to 10,000 feet. Starts, however, have been accomplished at altitudes up to 15,000 feet.

If left engine start is successful:

6. Flight controls — NORM.
7. Left engine operate switch — NORM.
8. Left throttle — MAX.

NOTE

- Ensure the operating engine is at 85% core rpm speed or above.
9. Refer to SINGLE-ENGINE RESTART procedure.

If left engine start is unsuccessful:

6. Left throttle — OFF.
7. Left engine operate switch — NORM.

NOTE

- APU generator should be turned on after APU comes up to speed to provide electrical power for hydraulic pump cooling.
8. Crossfeed switch — CROSSFEED.
 9. Right engine operate switch — MOTOR.
 10. Right engine — START.
 11. Flight controls — NORM.
 12. Right engine operate switch — NORM.
 13. APU generator switch — PWR.
 14. Refer to SINGLE-ENGINE LANDING procedure.

ENGINE/APU FIRE

Engine Fire

A possible engine fire is indicated when the engine fire light comes on. A malfunction of the indicating circuit also is possible, and the presence of an actual fire should be confirmed. If an actual engine fire exists, there will normally be visual indications of fire in the engine nacelle area. Engine fires also are usually accompanied by erratic or abnormal engine instrument readings, loss of thrust, or mechanical failure indications such as engine vibration. If an engine fire light comes on, retard the throttle (if practical) and check for other fire indications.

Reducing power on the affected engine may cause the fire light to go off. If the fire light goes off, check the fire detection circuit by pressing the FIRE DETECT BLEED AIR LEAK TEST button. If the fire light tests good, this indicates that the circuit is reliable. If the fire light does not test good, this indicates a failure of the test or detection system, warranting increased attention to visual or other fire indications. Experience has shown that engine fires can occur without causing the engine fire light to come on immediately. Therefore, absence of the light provides no assurances when there are other positive fire indications.

APU Fire

If the APU fire light comes on, it indicates a possible fire in the APU area. On [47] aircraft (no firebox

INFLIGHT EMERGENCIES (CONT)

over APU), a valid APU fire indication would probably be accompanied by a BLEED AIR LEAK caution light. On [33] aircraft (firebox over APU), the BLEED AIR LEAK light should not come on unless the hot condition exists outside the firebox. In either case, illumination of the APU fire and BLEED AIR LEAK lights at the same time indicates that hydraulic, fuel, electrical, flight control, and ECS equipment are being exposed to heat or fire. Wiring for instruments and electrical equipment is more susceptible to damage than flight controls and fluid lines. Erratic instrument indications or equipment malfunctions tend to confirm a fire. If the APU fire and/or BLEED AIR LEAK lights go off, a successful FIRE DETECT BLEED AIR LEAK TEST indicates that the circuits are reliable. An unsuccessful test means that the light(s) may have gone off due to fire damage, and other indicators must be closely monitored. If the APU fire light comes on, prompt action is necessary to preclude the spread of fire within the fuselage.

If an engine fire is confirmed or at first indication of APU fire:

1. **THROTTLE/APU — OFF.**
2. **FIRE HANDLE — PULL.**
3. **AGENT — DISCHARGE.**

NOTE

- The design configuration of the A-10, with the engines mounted in nacelles external to the aft fuselage, is less subject to rapid spread of catastrophic fire than internally mounted engines. The fire extinguishing system offers a high probability of controlling fire in the nacelle. Propagation of engine fire to the fuselage proper is restricted by a stainless steel firewall in the engine mount pylon. Differential pressure between the nacelle and the fuselage could allow heat or fire to transfer to the fuselage if the pylon firewall fails. The initial instrument indication to the pilot that the firewall has failed will probably be a BLEED AIR LEAK light. The canopy design allows the pilot to monitor the engine and nacelle section visually if fire indications persist.

If an engine is shut down:

4. SAS switches — OFF.
5. Yaw SAS switch (operable channel only) — Engage (if desired).
6. APU — START (below 15,000 feet MSL).
7. APU generator switch — PWR.
8. Crossfeed switch — CROSSFEED.
9. Land as soon as possible using SINGLE-ENGINE LANDING procedure.

If the APU is shut down for fire:

4. Land as soon as possible, while continually checking for fire.

WARNING

- If an inflight fire in the APU compartment continues to burn out of control, ejection is recommended.

ENGINE FAILURES/OVERTEMP

- Flameouts, characterized by a decrease in ITT, rpm (both fan and core), and fuel flow, are usually associated with fuel starvation or fuel interruption, but may be associated with operation outside the normal flight envelope.
- A compressor stall is characterized by an increase in ITT along with a hang-up or rollback in core and fan rpm. Experience has shown that a non-recoverable compressor stall will result in rising ITT (which may exceed limits and peg the ITT gauge), and a decrease in fan and core rpm. Compressor stalls are usually associated with aircraft AOA's above wing stall AOA.
- A mechanical failure is usually characterized by unusual engine noise and/or vibration.
- An engine overtemp is indicated by ITT gauge or the L- or R-ENG HOT caution light coming on.

INFLIGHT EMERGENCIES (CONT)

If any of the above occur:

1. Control stick — Unload to ensure operation within flight envelope.
2. Throttle — Retard to minimum practical. (Do not select IDLE.)

CAUTION

- On aircraft with an automatic start system, retarding the throttle to IDLE following a flameout will result in a hot start condition, since fuel and ignition will be available.
- A nonrecoverable compressor stall must be cleared by shutting down the engine and restarting.

If engine is flamed out, does not recover within rpm and/or ITT limits, or mechanically failed:

3. Throttle — OFF.

NOTE

- If rapid cooldown is not observed within 5 seconds of shutdown, ensure that the affected throttle is positioned against the aft/OFF stop to shut off all fuel flow and permit engine cooling.
4. SAS switches — OFF.
 5. Yaw SAS switch (operable channel only) — Engage (if desired).
 6. APU — START (below 15,000 feet MSL).
 7. APU generator switch — PWR.
 8. Crossfeed switch — CROSSFEED (unless fuel leak suspected).
 9. Refer to SINGLE-ENGINE RESTART or SINGLE-ENGINE LANDING procedure, as appropriate.

CAUTION

- An engine restart after a compressor stall, rollback, or flameout should only be attempted if required to safely land the aircraft. Engine damage may have occurred and not be apparent to the pilot.
- If ITT limits are exceeded or internal damage is suspected, do not restart unless a critical thrust requirement exists.

ENGINE OIL SYSTEM MALFUNCTION

If engine oil pressure is not within the operating limits:

1. Throttle — IDLE.
2. Throttle — OFF if minimum oil pressure of 30 psi cannot be maintained.

CAUTION

- Total loss of oil pressure with simultaneous loss of core speed indication is a positive sign of oil pump driveshaft failure, and engine failure can occur in 1 – 3 minutes.

If an engine is shut down:

3. SAS switches — OFF.
4. Yaw SAS switch (operable channel only) — ENGAGE (if desired).
5. APU — START (below 15,000 feet MSL).
6. APU generator switch — PWR.
7. Crossfeed switch — CROSSFEED.

NOTE

- If single-engine flight must be continued for an extended period, it will be necessary to place the crossfeed switch to CROSSFEED and manage fuel to ensure the cg remains within limits.
8. Refer to SINGLE-ENGINE LANDING procedure.

INFLIGHT EMERGENCIES (CONT)

ENGINE START CYCLE LIGHT ON

If the **ENG START CYCLE** light comes on during flight:

1. L and R **ENG START** circuit breakers — Open.

NOTE

- If subsequent airstart becomes necessary, ensure appropriate circuit breaker is closed.

ITT CONTROL SYSTEM FAILURE/LOW CORE RPM AT MAX POWER

Failure of the ITT control system is indicated by exceeding maximum ITT, fluctuating engine parameters when operating at core speeds above 80%, or by the inability to attain core speeds above 80%. The temperature control system can be deactivated by placing the appropriate engine fuel flow switch in **OVERRIDE**. In **OVERRIDE**, the engine will be speed controlled, unbiased by temperature.

CAUTION

- With the engine fuel flow switch in **OVERRIDE**, close monitoring of ITT is required to prevent possible overtemperature. Since ITT may rise significantly upon selection of **OVERRIDE**, the throttle should be retarded until core speed starts to decrease prior to this action to prevent an overtemperature condition

1. Throttle (affected engine) — Retard (until core speed starts to decrease).
2. Engine fuel flow switch (affected engine) — **OVERRIDE**.
3. Throttle — Adjust slowly and monitor ITT to maintain within limits.
4. Cross-check engine instruments on both engines to confirm proper operation of the ITT gauges by comparison of fan speed levels at same ITT.

SINGLE-ENGINE RESTART

1. Throttle (affected engine) — **OFF**.

NOTE

- If rapid cooldown is not observed within 5 seconds of shutdown, ensure that the affected throttle is positioned against the aft/**OFF** stop to shut off all fuel flow and permit engine cooling.
 - If possible, descend below 20,000 feet MSL and increase airspeed to improve starting characteristics.
2. **APU** — **START** (below 15,000 feet MSL).
 3. **APU** generator switch — **PWR**.
 4. Throttle (operating engine) — **MAX**.
 5. Engine operate switch (affected engine) — **MOTOR**.

WARNING

- A 4% thrust loss will be experienced even with the **APU** running since above approximately 80% core RPM, engine bleed air is at a higher pressure than the **APU** can supply. This 4% thrust loss may be sufficient to preclude sustained level flight or seriously degrade single-engine climb performance in a critical thrust situation.

NOTE

- Placing the engine operate switch to **MOTOR** will provide rapid cooling of the engine. Cool engine until ITT below 150°C (100°C above 15,000 feet MSL).
6. Inoperative engine — **Start**.
 7. Engine operate switch (affected engine) — **NORM**.

INFLIGHT EMERGENCIES (CONT)

If restart was unsuccessful:

8. Throttle (affected engine) -- OFF.
9. Refer to SINGLE-ENGINE LANDING procedure.

If restart is successful:

8. SAS switches — ENGAGE.
9. Crossfeed — As required.
10. Anti-skid — ENGAGE.

NOTE

- There is a possibility for engine failure after successful engine restart.

WINDMILL AIRSTART

1. Place aircraft in a dive to obtain and/or maintain sufficient windmill start airspeed.

WARNING

- Accomplishing a windmill airstart following a dual engine flameout will require a high speed dive in manual reversion. If engine start is unsuccessful, high control forces will be necessary to recover from the dive. If pitch trim is inoperative, ejection may be the pilot's only option.

It takes between 6,000 and 8,000 feet in a steep dive (at least 30° dive angle) with power off to gain windmill airstart speed from normal cruise speeds. (See figure 3-3 for the windmill start envelope.) If an assisted start is unsuccessful, then a windmill start may be attempted, provided the inoperative engine shows no signs of seizure or other damage. ITT will rapidly fall to 150°C or below as airspeed increases.

2. Bleed air switch — OFF.
3. Crossfeed switch — CROSSFEED.

WINDMILL START ENVELOPE

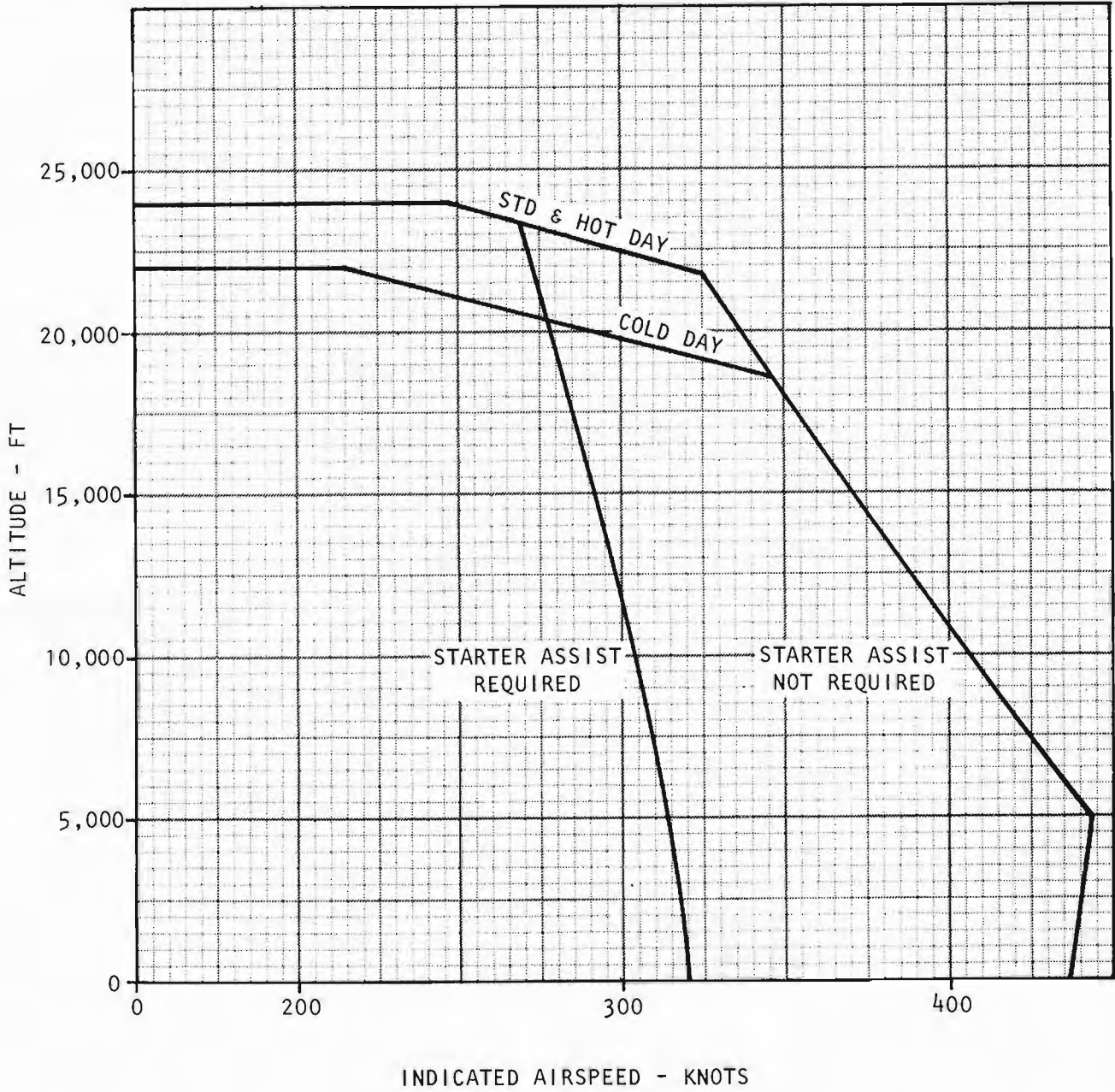

Figure 3-3

1-10A-3-6

Change 3

3-23

INFLIGHT EMERGENCIES (CONT)

When ITT below 150°C and inside the windmill start envelope:

4. Throttle(s) — MAX.
5. Ignition button(s)/engine operate switch(es) affected engine(s) — Depress/IGN.

CAUTION

- On **8** and **45**, if both engines are inoperative and windmilling, selection of IDLE will open both bleed valves and the ATS valve on one engine, allowing the faster starting engine to bleed into the open starter. This will lead to slow acceleration or prevent a successful start.

NOTE

- Both engines may be windmill-started simultaneously. Placing the crossfeed switch in CROSSFEED allows either engine an equal chance of starting first during a double-engine flameout; otherwise, the left engine has the best chance of starting first due to positive fuel pressure from the DC fuel pump.

GENERAL

APU FLUCTUATIONS/OVERTEMPERATURE/OVERSPEED

If the APU experiences fluctuations, overtemperature, or overspeed condition, the pilot should shut down the APU.

1. APU — OFF.

If the APU is needed for engine start or electrical power, restart and monitor. If either or both engines are running at or above approximately 80% core rpm during APU operation, failure of the bleed air check valve in the bleed air system will cause unstable operation of the APU and possibly serious damage. Core speeds above 80% rpm allow high pressure bleed air from the engine to override low pressure APU air when this check valve fails. The resulting back pressure on the APU causes fluctuating APU rpm and

EGT, surging, etc., and could result in an overtemp and possible fire if immediate action is not taken. If either engine is operating above 80% core rpm and the APU shows the above signs of unstable operation, the problem may be resolved by placing the bleed air switch to OFF. If the APU stabilizes, a failed check valve is likely. If this problem is discovered on the ground, retard the throttle(s) to idle and abort the mission. If airborne and the APU is required, leave the bleed air switch OFF and land as soon as practical.

BLEED AIR LEAK/SERVICE AIR OVERHEAT

A bleed air leak or overheat in the environment system precooler may be indicated by one of the following:

- BLEED AIR LEAK caution light on.
- Unexplained loss of environment system air.
- SERVICE AIR HOT caution light on.

If any of the above occur:

1. Bleed air switch — OFF.
2. APU — OFF.
3. Oxygen — 100%.
4. Temp/press control — RAM (if required).

NOTE

- Cockpit ventilation and limited defogging can be obtained by placing the temp/press control to RAM.
- 5. Land as soon as practical.

INFLIGHT EMERGENCIES (CONT)

CANOPY -- LOSS OF

If canopy is lost, slow the aircraft, bend forward, and lower the seat simultaneously. Check condition of the engines and aircraft tail. Stow all remaining loose equipment. Flight tests have shown that no major problem exists up to at least 350 knots; however, 200 knots or less will greatly aid pilot comfort.

CANOPY UNLOCKED LIGHT ON

If the CANOPY UNLOCKED light comes on during flight, slow the aircraft to the lowest practical speed:

1. Oxygen -- 100%.
2. Descend to 25,000 feet MSL or below.
3. TEMP/PRESS control -- DUMP.
4. BLEED AIR switch -- OFF.
5. APU -- OFF.

This will depressurize the canopy seal. The light may then go off when the canopy control switch is momentarily held in CLOSE.

6. Canopy control switch -- CLOSE momentarily.

If light goes off:

7. BLEED AIR switch -- BLEED AIR.
8. TEMP/PRESS control -- NORM.

If light remains on:

9. Land as soon as practical.

CANOPY/WINDSHIELD CRACK

1. Oxygen -- 100%.
2. Descend to 25,000 feet MSL or below.
3. TEMP/PRESS control -- DUMP.

If center windshield is cracked:

4. WINDSHIELD DEFOG/DEICE switch -- OFF.

5. Land as soon as practical.

COCKPIT -- LOSS OF PRESSURIZATION

Loss of cockpit pressurization will be indicated on the cockpit pressure altitude indicator by an increase of normal cabin altitude.

1. Oxygen -- 100%.

2. Descend to 25,000 feet MSL or below.
3. TEMP/PRESS control -- NORM.
4. MAIN AIR SUPPLY switch -- SUPPLY.
5. BLEED AIR switch -- BLEED AIR.
6. CANOPY DEFOG control -- MAX.

If no service air entering cockpit inlets:

7. Perform BLEED AIR LEAK/SERVICE AIR OVERHEAT procedure.

COCKPIT OVERPRESSURIZATION

Cockpit overpressurization, due to a failure of the cockpit air pressure regulator, will be indicated on the cockpit pressure altitude indicator by a decrease in normal cabin altitude.

1. Descend to 25,000 feet MSL or below.
2. TEMP/PRESS control -- DUMP.

COCKPIT OVERTEMPERATURE

NOTE

- No cockpit overtemperature warning is provided.

If cockpit temp cannot be controlled by the TEMP LEVEL and FLOW LEVEL controls and heat is excessive:

1. **MAIN AIR SUPPLY -- OFF.**

NOTE

- With MAIN AIR switch OFF the following will not be available:
 - External tank pressurization
 - Canopy Defog
 - Canopy seal
 - Cabin pressurization
 - Rain removal
 - Anti G suit

2. BLEED AIR switch -- OFF.
3. APU -- OFF.
4. Oxygen -- 100%.
5. Descend to 25,000 feet MSL or below.

TO 1A-10A-1

If heat cannot be tolerated:

6. Canopy -- Jettison.

If hot airflow stops and bleed air is required:

6. CABIN AIR COND control -- MAN and hold in COLD for approximately 30 seconds.

7. BLEED AIR switch -- BLEED AIR .

8. MAIN AIR SUPPLY switch -- SUPPLY.

9. CABIN AIR COND control -- As required.

INFLIGHT EMERGENCIES (CONT)

DITCHING

Ditching is not recommended; however, if necessary:

1. Gear -- UP.
2. Stores -- Jettison (if necessary).
3. Flaps -- DOWN.
4. Speed brakes -- Close.
5. Shoulder harness -- LOCK.
6. Canopy -- Jettison.
7. Oxygen -- 100%.
8. Touch down with minimum sink rate.

EJECTION PROCEDURES

Before Ejection

Escape from the airplane must be made with the ejection seat. After ejection, all seat/man separation and recovery parachute functions are automatically accomplished. Under level flight conditions, eject above 2,000 feet AGL whenever possible. Under undercontrollable conditions, eject above 10,000 feet AGL whenever possible.

WARNING

- Do not delay ejection below 2,000 feet AGL for any reason. Accident statistics emphatically show a progressive decrease in successful ejection as altitude decreases below 2,000 feet AGL.

At low altitude, the chances for successful ejection can be greatly increased by pulling up to exchange airspeed for altitude. Ejection should be accomplished while in a positive rate of climb with the aircraft approximately 20° nose-up, and before the start of any sink rate. The ejection system design provides a capability for a safe ejection at ground level if the sink rate and attitude limits of figures 3-4 and 3-5 are satisfied. This capability must not be used as a basis for delaying ejection when above 2,000 feet AGL. See figure 3-4 for minimum ejection altitude versus sink rate. See figure 3-5 for minimum ejection altitude versus airspeed and dive angle. See figure 3-6 for ejection seat operation. See figure 3-7 for ejection system operating mode envelope.

If time and conditions permit:

1. Turn IFF to EMER, Mode 3/A, Code 7700.
2. Transmit "May Day" call on UHF guard channel.
3. Stow loose equipment.

MINIMUM EJECTION ALTITUDE vs SINK RATE & SPEED

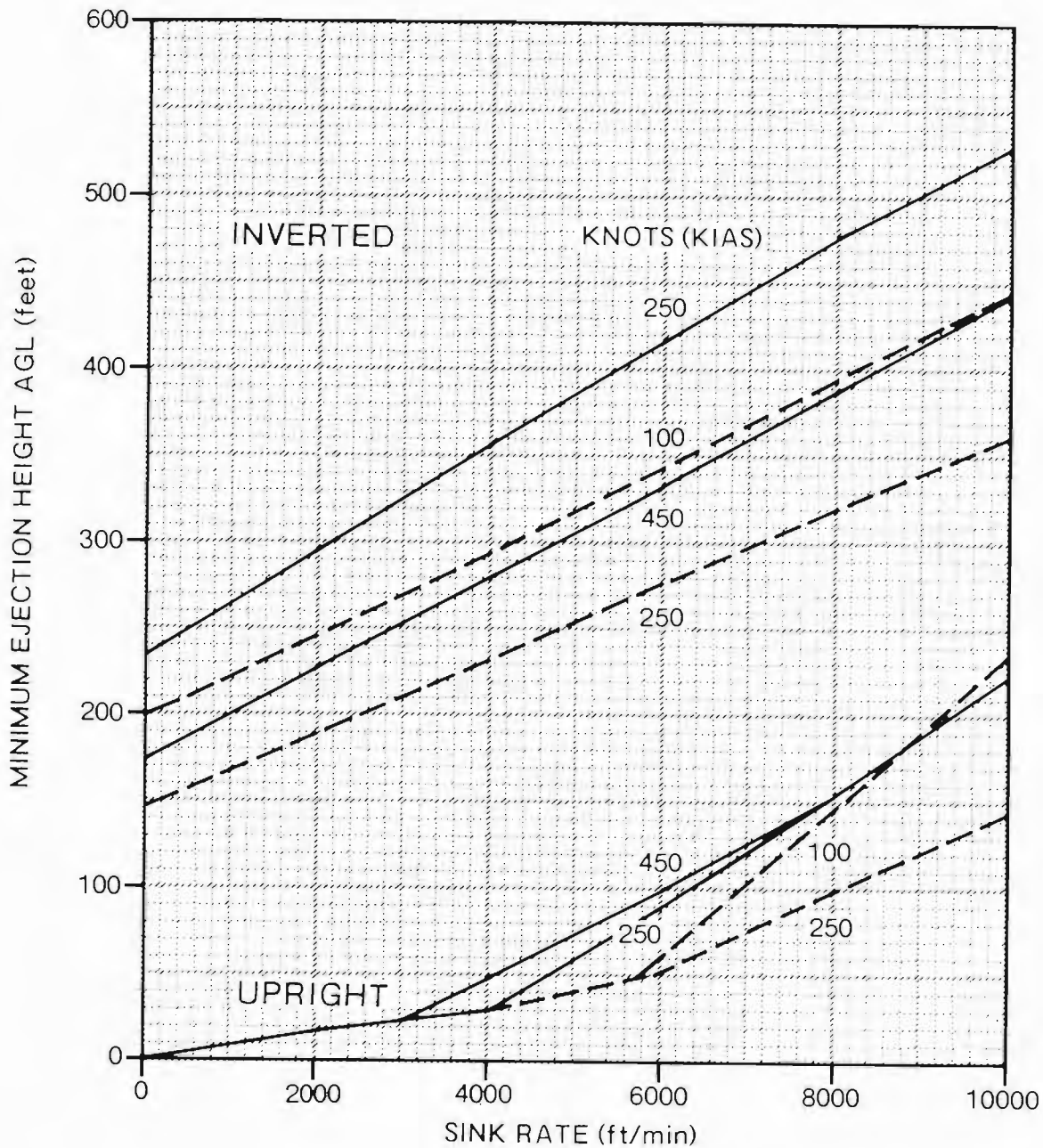

———— MODE 2
 - - - - - MODE 1

ZERO PILOT REACTION TIME
 WINGS LEVEL
 SEA LEVEL
 95 PERCENTILE PILOT (215 lbs)
 0.3 SEC PRE-EJECTION DELAY INCLUDED

Figure 3-4

MINIMUM EJECTION ALTITUDE vs DIVE ANGLE & SPEED

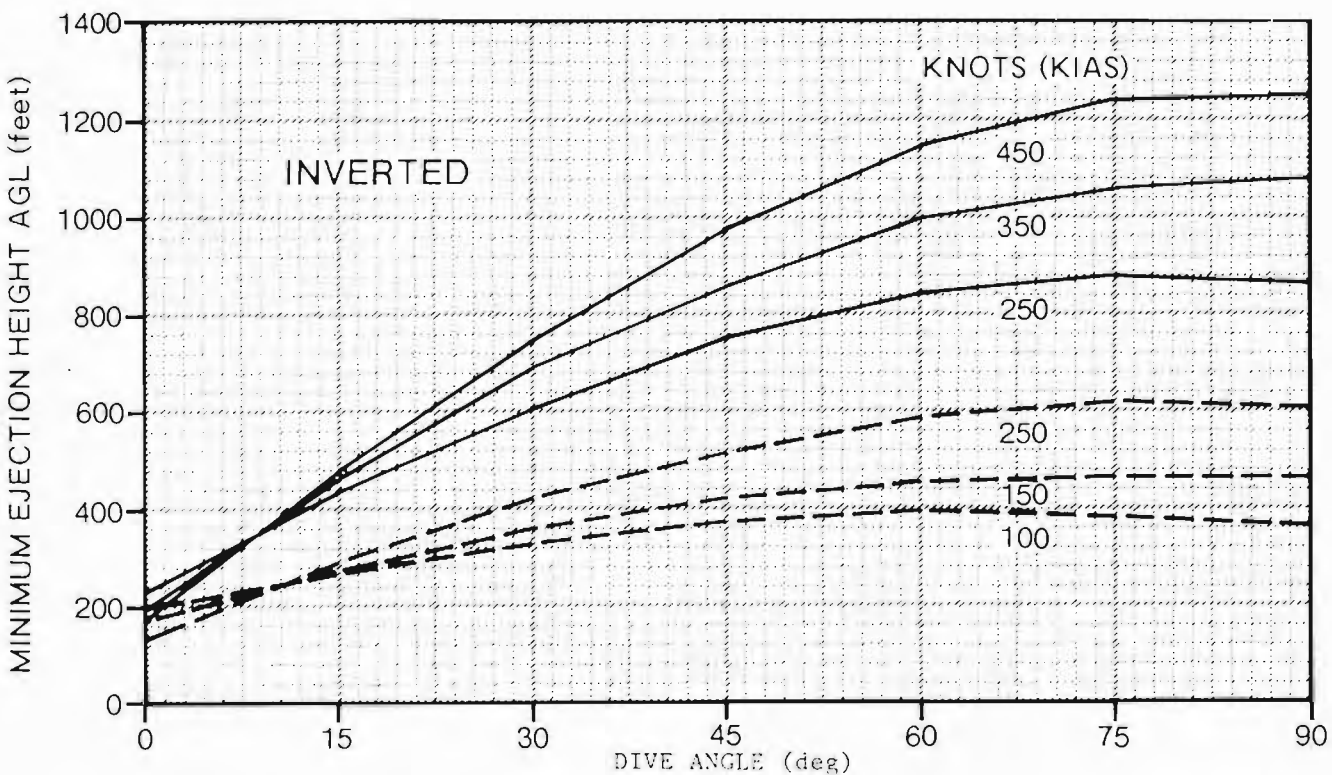
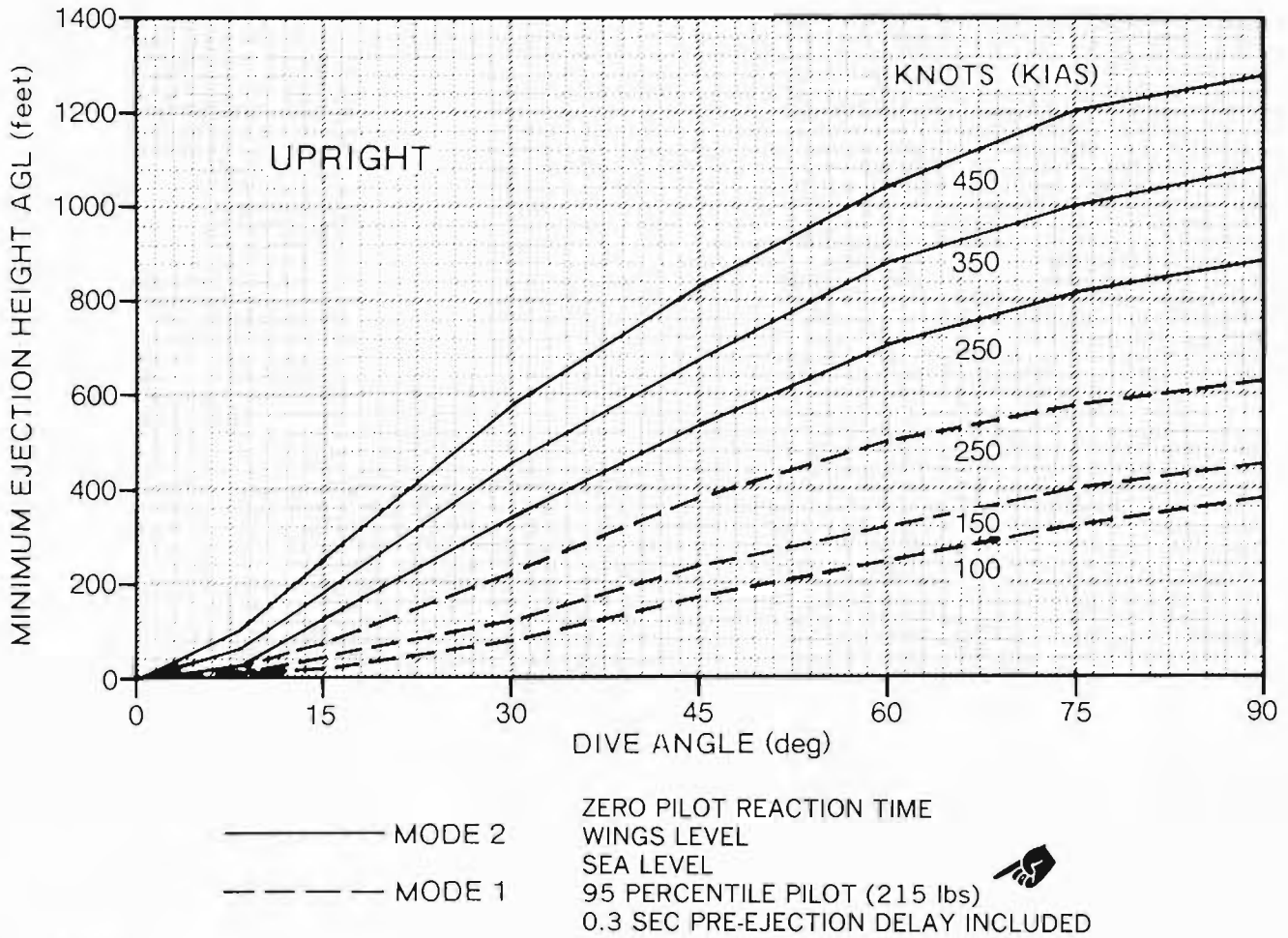

Figure 3-5

EJECTION SEAT OPERATION

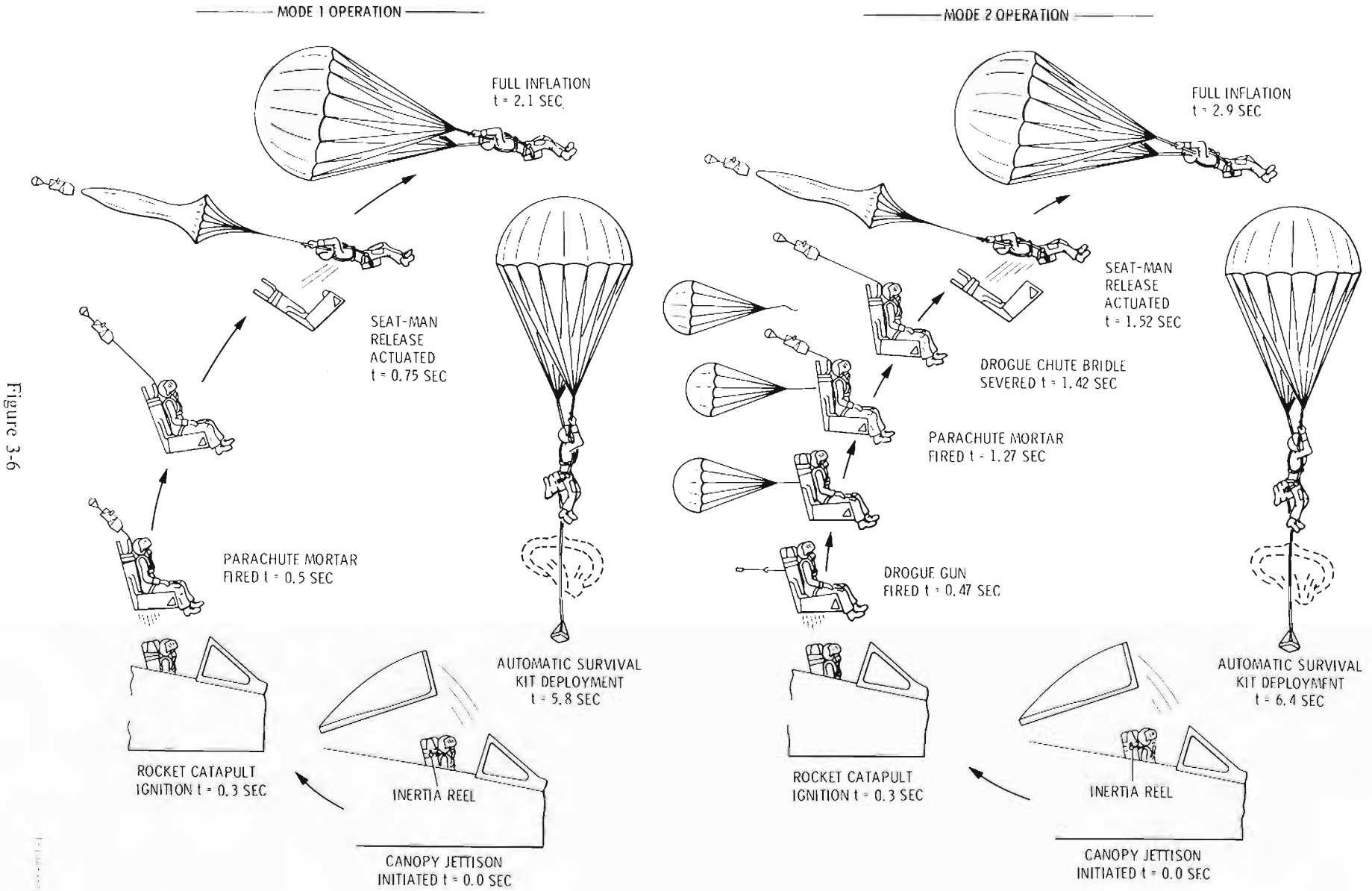
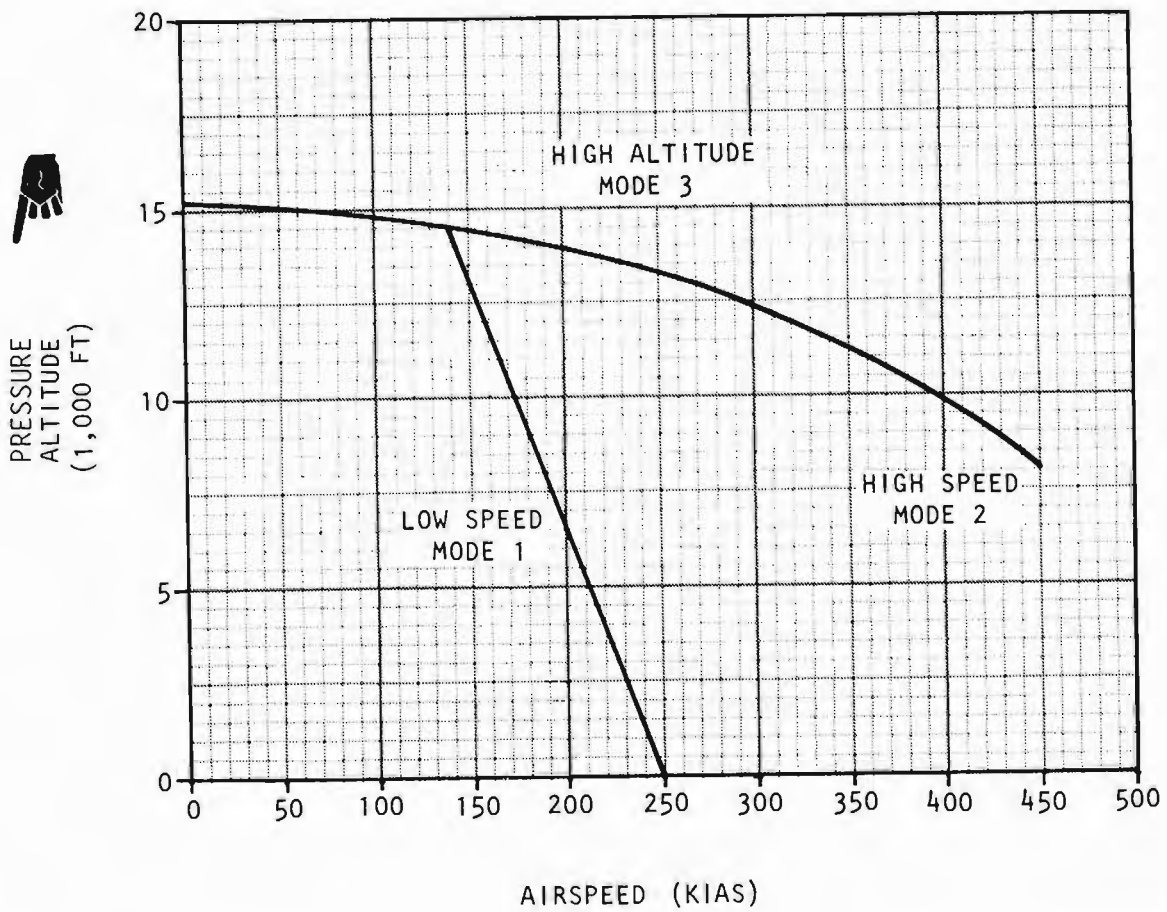

Figure 3-6

EJECTION SYSTEM OPERATING MODE ENVELOPES



1-10A-3-9

Figure 3-7

Change 3

3-29

INFLIGHT EMERGENCIES (CONT)

4. Tighten oxygen mask, lower helmet visor, tighten chin strap.
5. Turn toward uninhabited area.
6. Trim aircraft for lowest practical speed with wings level prior to ejection.
7. Leave feet on rudder pedals and sit erect with spine straight and head firmly against headrest.

WARNING

- If the inertia reel straps bind and cannot be freed, the preceding step will minimize the risk of injury during ejection.

Ejection

1. Ejection handles (both, if possible) — PULL.

WARNING

- Initiating ejection with both hands will reduce the possibility of sustaining flailing injuries.
- Do not pull the restraint emergency release handle prior to ejection. This disconnects the lap belt and inertia reel straps. Should this occur, safe ejection is impossible. The handle is provided for use in the event of automatic recovery system failure after ejection.

No other pilot action should be required unless a malfunction occurs.

If automatic man/seat separation does not occur below 15,000 feet MSL:

2. Simultaneously push up on the left pitot support and restraint emergency release handle — PULL.

WARNING

- Do not attempt to open the seatbelt manually. This action will leave the shoulder harness connecting the man and

seat, and may result in a seat/man relationship that would prevent reaching the restraint emergency release handle, thereby precluding man/seat separation, and drastically reducing the probability of a successful parachute deployment.

3. Kick free of seat.

If the parachute assembly fails to separate from the seat:

4. Parachute risers — Jerk.

If, after parachute opening, the survival kit does not automatically deploy:

5. Survival kit — Deploy manually.

WARNING

- If the survival kit has not deployed automatically, pull the manual release ring. If the survival kit still has not deployed, shake or strike the sides of the kit to free the kit closures and allow the contents to drop on the 25-foot lanyard.

FLAMEOUT LANDING

Ejection is recommended if a landing cannot be made on a prepared surface, or if the pilot is not proficient in simulated flameout patterns. A flameout approach may be attempted if any of the three key positions (figure 3-8) can be achieved. The flameout pattern is a very steep, almost circular, approach with low key displaced almost 8,000 feet from the runway. Bank angle in the flameout pattern should be limited to 30° if possible, and rollout on final must be initiated early due to the slow roll response of the aircraft in manual reversion. Maintain the airspeed at a minimum of 150 KIAS until flaring the aircraft. The flare should be initiated at 200 – 300 feet AGL to arrest the high sink rate and place the aircraft onto a shallow flight path (1 1/2 – 2°) by 50 feet AGL. The aircraft should then be flown onto the runway, since pitch response becomes extremely degraded in ground effect below 50 feet AGL. The aircraft will touch down firmly and the nose gear will drop rapidly to the runway. The use of pitch trim is not recommended during the flare since large, uncontrollable changes in pitch attitude may result.

FLAME OUT LANDING PATTERN

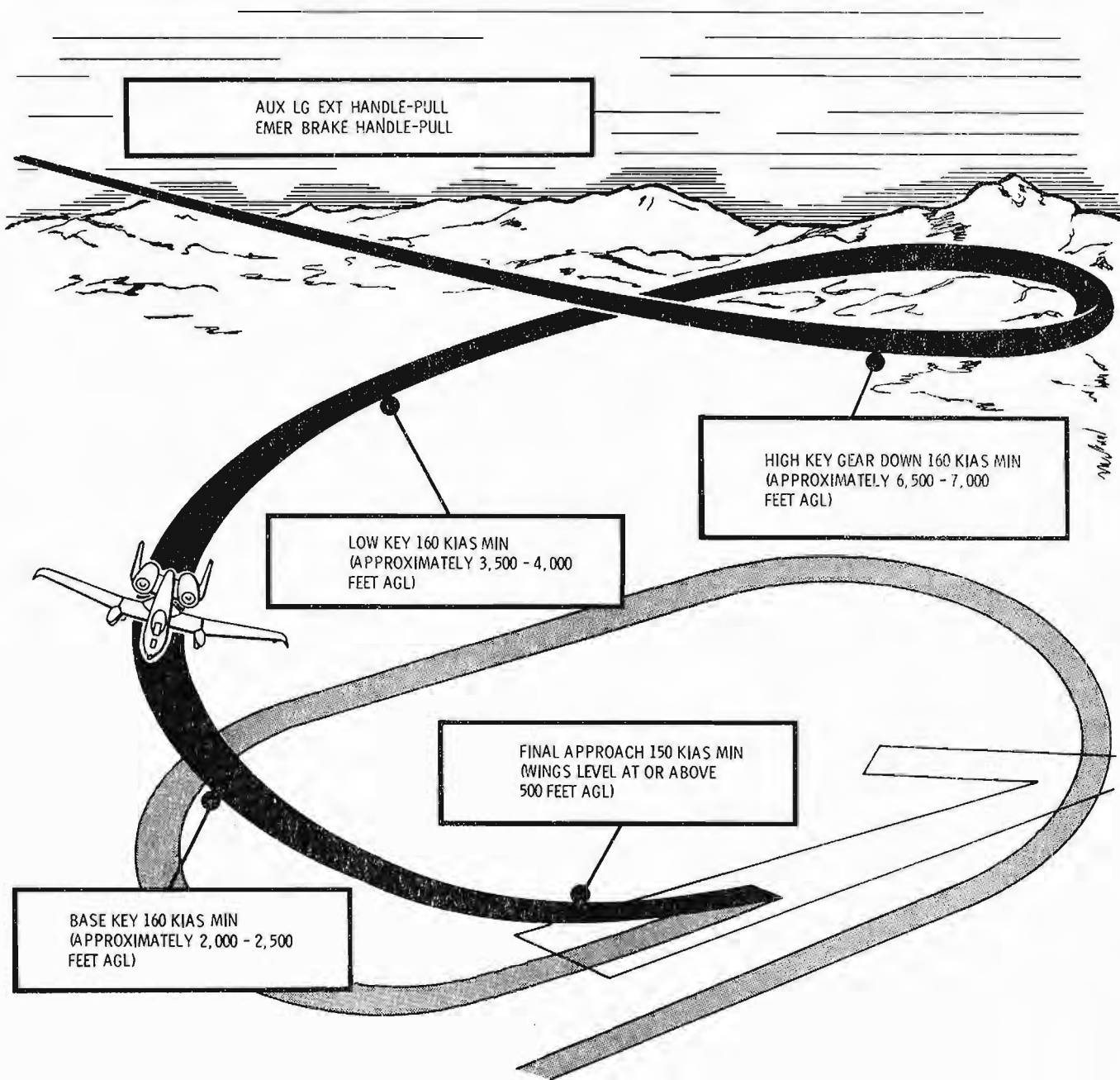

NOTE:

- PLAN FINAL TURN TO ACCOMPLISH TOUCHDOWN AT ONE THIRD POINT ON RUNWAY.
- SPEED SHOWN ARE FOR AIRPLANE GROSS WEIGHT OF 30,000 POUNDS. INCREASE ALL SPEEDS 2 KIAS FOR EACH 1,000 POUNDS OVER 30,000 POUNDS GROSS WEIGHT.

1-10A-3-10

Figure 3-8

INFLIGHT EMERGENCIES (CONT)

CAUTION

- Pitch response becomes extremely degraded as the aircraft enters ground effect below 50 feet AGL. The flare must be initiated prior to passing 200 feet AGL to arrest the sink rate before entering ground effect.

Actual touchdown should be planned for approximately 1/3 down the runway at about 120 KIAS. Emergency brakes must be used to stop the aircraft straight ahead on the runway. No anti-skid protection, flaps, or speed brakes will be available to help slow the aircraft. Time from high key to touchdown will be approximately 2 minutes. Wind effects must be considered early in the pattern; for example, a 10 knot headwind will cause the touchdown point to move approximately 2,000 feet short of the no-wind touchdown point.

Flameout patterns are highly demanding and not recommended; however, if necessary:

1. Landing gear handle — Down.
2. AUX LG EXT handle — Pull. (Gear may take up to 30 seconds to extend.)
3. Emergency brake handle — Pull.
4. High key — Gear down 160 KIAS minimum (approximately 6,500 - 7,000 feet AGL).
5. Low key — 160 KIAS minimum (approximately 3,500 - 4,000 feet AGL).
6. Base key — 160 KIAS minimum (approximately 2,000 - 2,500 feet AGL). Plan final turn to touchdown at 1/3 point on runway.
7. Final approach — 150 KIAS minimum (wings level at or above 500 feet AGL).

NOTE

- Speeds shown are for aircraft gross weight of 30,000 lbs. Increase all speeds 2 KIAS for each 1,000 lb over 30,000 lb gross weight.

FLAP ASYMMETRY

In the event of wing flap asymmetry:

1. Flap lever — Select position used before asymmetry occurred.

If flaps remain asymmetrical:

2. Flap lever — MVR at safe speed and altitude in attempt to equalize flaps.

If flaps still remain asymmetrical:

3. Flap emergency retract switch — EMER RETR.

WARNING

- If the flap asymmetry cannot be corrected, the AOA system will be unreliable and landing approach should be made at no-flap airspeeds.
- 4. Refer to CONTROLLABILITY/STRUCTURAL DAMAGE procedure.

SPEED BRAKE ASYMMETRY OR FAIL TO CLOSE

1. Speed brake emergency retract switch — EMER RETR.

AILERON/ELEVATOR CONTROL JAMS

WARNING

- Control jams that cannot be identified by a jam indicator light cannot be overcome by disengaging a flight control path.
- The jam indicator lights must be used to determine the jammed surface. Stick movement in either direction can exert the force required to cause the light to come on.

If control response is inadequate for flight and landing:

1. Apply pressure against the jam and check jam indicator lights.

INFLIGHT EMERGENCIES (CONT)

If a jam indicator light comes on:

2. Displace emergency disengage switch toward the affected jam indicator light.

If no jam indicator light comes on:

2. Apply rapid stick motion away from the jam or maximum force against the jam.

WARNING

- MRFCS should not be selected, as it will not assist in alleviating the jam, and will make control of the aircraft more difficult.

Prior to Landing:

3. Refer to CONTROLLABILITY/STRUCTURAL DAMAGE procedure.

NOTE

- A small amount of roll control may be achieved following an unresolved white area jam by disengaging an aileron and using roll trim.

FAILURE TO SHIFT INTO MANUAL REVERSION

If hydraulic power is available:

1. Flight controls — NORM.

If hydraulic power is not available:

WARNING

- Very high lateral stick forces, approaching locked stick feel, will occur. The aircraft may roll off, usually toward the side of the nonfunctioning shifter.

1. AIL TAB circuit breaker — Check in.

As a last resort, if roll control is not available:

2. AIL DISENG switch — Move toward aileron jam indicator light.

WARNING

- Flight in manual reversion with one aileron disconnected has not been tested and may not be possible.

3. AIL TAB circuit breaker — Open, for disengaged aileron, to prevent tab shift after disengagement.

FAILURE OF AN AILERON TAB TO SHIFT OUT OF MANUAL REVERSION

1. AIL TAB circuit breaker — Check in.

If satisfactory roll control is not available:

2. Identify the nonfunctioning aileron/tab shifter by:

- AIL TAB caution light remains on.
- AIL TAB circuit breaker open.
- Aileron tab moves without aileron movement.
- Stick movement toward the side of the malfunctioning shifter.

3. Aileron emergency disengage switch — Disengage the malfunctioning aileron.

4. Pull AIL TAB circuit breaker for side with nonfunctioning shifter, to provide roll trim and prevent subsequent shifting.

NOTE

- With one side disengaged, maximum roll capability will be reduced approximately 50% and stick input for a given roll will be twice normal. Roll trim can be restored by pulling the AIL TAB circuit breaker for the side with the nonfunctioning shifter. The corresponding AIL TAB caution light will go off when this circuit breaker is pulled and both ailerons will respond to roll trim.

5. Refer to CONTROLLABILITY/STRUCTURAL DAMAGE procedure.

INFLIGHT EMERGENCIES (CONT)

OUT-OF-CONTROL RECOVERY

Control neutralization will recover all out-of-control situations. Throttles should be immediately positioned to IDLE to reduce the possibility of engine compressor stalls.

Recoveries from uncommanded roll reversals or incipient spins are rapid with few oscillations. Uncommanded roll accelerations may continue for several rolls after neutralizing controls with pitch and AOA oscillations possibly occurring during recovery. Neutral controls must be maintained until oscillations have ceased. Rushing recovery may result in secondary stalls and excessive loss of altitude. Since PSGs and spin recoveries normally result in a steep, nosedown attitude, the dive recovery technique is critical in minimizing altitude lost. Use back stick pressure short of stall AOA to optimize recovery. PSG recoveries require from less than 1,000 to as much as 8,000 feet altitude. Spin recoveries require from 4,000 - 6,000 feet altitude for incipient, half-turn spins, and 10,000 feet altitude for three-turn developed spins. The following procedure is recommended for all departures from controlled flight.

1. THROTTLES — IDLE.

2. CONTROLS — NEUTRAL.

If a spin is confirmed:

3. Rudder — Abruptly full opposite turn needle.

An erect spin can be confirmed with turn needle pegged with airspeed at or below 120 KIAS and an AOA consistently above 25 units and usually pegged. The turn needle will be inoperative and centered and AOA may not be available, if both engines are flamed out.

If an engine flameout or overtemperature occurs, perform the appropriate engine malfunction procedures after recovering to normal controlled flight.

PITCH/YAW SAS DISENGAGEMENT

Pitch and/or yaw SAS disengagement in flight is indicated by the respective caution light(s) coming on.

If pitch SAS is disengaged:

1. Pitch SAS — Reengage one channel at a time. If two-channel engagement cannot be maintained, leave pitch SAS OFF.

WARNING

- The pitch SAS fail-safe monitoring feature does not function during single-channel SAS operation. If pitch SAS operation cannot be maintained with both channels engaged, pitch SAS should be turned OFF.
- If an undesirable aircraft transient is experienced as the pitch SAS switches are engaged, leave pitch SAS OFF.

CAUTION

- Single-channel operation will result in repetitive loading of the elevator interconnect shear bolts.

NOTE

- A nose up trim change occurs when pitch SAS fails while speed brakes are extended.

If yaw SAS is disengaged:

1. Yaw SAS — Reengage one channel at a time. If two-channel engagement cannot be maintained, engage operable channel if yaw damping and yaw trim are desired.

INFLIGHT EMERGENCIES (CONT)

WARNING

- The yaw SAS fail-safe monitoring feature does not function during single-channel SAS operation. Close formation or low altitude flight is not recommended during single channel SAS operation due to the possibility of an undesirable roll/yaw transient in the event of a yaw SAS hardover failure.
- If an undesirable aircraft transient is experienced as a yaw SAS switch is engaged, leave that switch OFF.

UNCOMMANDED PITCH/YAW INPUT

1. Attain coordinated flight and recover wings level.

WARNING

- Aileron input without rudder may result in a PSG. The PSG will manifest itself as a roll acceleration or roll reversal. Application of back stick without controlling the yaw input may result in a sideslip departure. If altitude permits, do not apply back stick until coordinated flight is obtained.
2. SAS/Anti-skid -- Paddle OFF.
 3. Anti-skid switch -- ANTI-SKID.

NOTE

- The malfunctioning SAS axis should remain off. If malfunctioning axis cannot be determined, the entire SAS should remain off.
4. Land as soon as practical.

TRIM FAILURE

1. Pitch/roll trim override switch -- EMER OVERRIDE.

2. Trim as necessary by use of the emergency pitch and roll trim switch.

HARS MALFUNCTION 64

If HARS is the operating attitude reference and the HARS caution light comes on, with one or both hydraulic power sources available, yaw damping and trim can be restored:

If INS is operating:

1. NAV mode select panel -- NAVCRS.
2. YAW SAS -- Reengage applicable channel(s).

If INS is not operating:

1. HARS/SAS -- OVERRIDE.
2. YAW SAS -- Reengage applicable channel(s).

INS FAILURE 62

NOTE

- In the event of an INS failure, resulting in the loss of INS attitude validity, the inputs to the SAS, HUD, HSI, and ADI will automatically be transferred to the HARS faster than the SAS or pilot can react to loss of the INS.
- In the event of total INS failure, all INS generated data and commands will be removed from the HUD. The INERTIAL NAV caution light will come on and the HARS Δ , on the navigation mode select panel, will come on indicating transfer into HARS.

If INS is operating:

1. NAV mode select panel -- NAVCRS or MAN.
2. NAV mode select panel -- Check HARS Δ on.
3. CDU mode select knob -- OFF.

SAS roll inputs are now supplied by HARS.

INFLIGHT EMERGENCIES (CONT)

In the event of INS navigation or heading channel failure (HSI power flag in view and HUD attitude and heading information no longer displayed):

WARNING

1. Navigation mode select panel -- HARS. HARS Δ will come on, HSI power flag will go out of view and HARS attitude information will be displayed on the HUD.

Failure to select HARS could result in improper attitude displays.

CONTROLLABILITY/STRUCTURAL DAMAGE

If handling characteristics for recovery are suspect, for whatever reason, perform a controllability check to determine if recovery is possible, and if so, under what conditions.

WARNING

- If there is damage to the landing gear, flap, or speed brake hydraulic lines, normal actuation of the system may cause the respective hydraulic system to vent overboard.

NOTE

- The leading edge of wings and right elevator as well as wingtips contain right hydraulic system lines. The trailing area of wings and leading edge of left elevator contain left hydraulic lines.

If there is damage, confirmed or suspected to hydraulic lines or wing structure:

1. Flap and speed brake emergency retract switches -- EMER RETR.

CONTROLLABILITY CHECK

1. Attain a safe altitude (minimum of 5,000 feet AGL if possible).
2. Reduce gross weight, if practical.

- If the aircraft has structural damage, artificial stall warning devices, AOA, and pitot static system may not be reliable.

3. While slowing to less than 185 KIAS, check roll, pitch, and yaw authority:
 - a. Perform a series of turns not to exceed 30° bank using normal rudder inputs.
 - b. Check pitch response up to $\pm 10^\circ$.
 - c. Check yaw response up to $\pm 5^\circ$.

WARNING

- If aircraft has structural damage, flight characteristics may be altered. It is important that the pilot determine the actual flight characteristics before attempting to recover the aircraft. Accomplishing this step prior to configuring will help demonstrate the amount of control authority available.

If there is no damage, confirmed or suspected to the hydraulic line or wing structure:

4. Establish landing configuration.

If there is damage, confirmed or suspected to hydraulic lines or wing structure:

4. Establish landing configuration.
 - a. LAND GEAR circuit breaker -- OPEN.
 - b. Landing gear handle -- DOWN.
 - c. AUX LG EXT handle -- Pull.
 - d. AUX LG EXT handle -- Push in (when landing gear indicates safe).
 - e. Emergency brake handle -- Pull.

NOTE

- With the landing gear circuit breaker open, normal brakes, anti-skid, and nosewheel steering will be inoperative. Pulling the emergency brake handle will provide braking capability.

5. Gradually slow aircraft to desired touchdown airspeed, or to minimum airspeed at which approximately one-half the available control in any axis is required to maintain altitude in wings level flight. If the aircraft can be controlled at speeds below the gear and flap limit speed, recovery is possible.

6. Prior to commencing recovery while still at a safe altitude, the pilot should maintain level flight

and make a series of turns duplicating the pattern and control inputs that will be used to recover the aircraft.

7. Maintain landing configuration and fly at 20 KIAS above the minimum control/desired touchdown speed on final approach and until landing is assured.

LANDING EMERGENCIES

EMERGENCY LANDING PATTERNS

The emergency landing pattern is a pattern to be flown when an emergency exists or there is a malfunction which could result in an emergency. The primary objective of the pattern is to land the aircraft safely on the first attempt with the least amount of risk. Because of the many variables involved, such as type of emergency, position and altitude in relation to the field, gross weight, fuel remaining, weather, populated areas, runway length, etc., a standard pattern cannot be prescribed. Depending on the circumstances, it might be desirable to utilize GCA, make a straight-in approach, enter the pattern from downwind or base leg, or make a circling pattern. Because of the various circumstances, the pilot's evaluation of factors and his judgment will determine the type of landing pattern to be flown. However, there are some general guidelines which are applicable regardless of approach selected. Reduce gross weight to minimum practical. Prior to establishing the landing configuration, maintain a minimum maneuvering airspeed of 200 knots and, when possible, 2000 feet AGL until beginning descent on final approach. This will allow the pilot to remain at controlled ejection altitude longer. The pattern should be planned to avoid abrupt, steep or hard turns, and large or abrupt power changes especially with a flight control malfunction, structural damage, or single-engine condition. Under these circumstances the minimum practical bank angle required should be used. Circumstances permitting, a long straight-in final should be planned and the landing configuration established on final. Should the nature of the emergency or other factors dictate establishing the landing configuration prior to final, 180 knots should be maintained until established on final (unless a higher airspeed is required due to structural damage). This airspeed will provide a margin of safety for maneuvering flight. If the pattern must be entered on downwind, base or from an overhead pattern, the pattern should be expanded, the landing configuration established prior to final, and roll-out on final should be at least 2 - 3 miles out. A normal 2 - 3° glide slope, unless otherwise directed, should be flown. For most emergencies, final approach airspeeds are increased and AOA decreased to provide adequate aircraft handling characteristics.

SINGLE-ENGINE FAILURE OR FIRE WHILE CONFIGURED FOR LANDING

The following procedure applies when an engine malfunction occurs after landing configuration is established.

When engine failure or fire occurs or is suspected while configured, advance throttles to MAX, retract speed brakes, and, if flaps are full down, select MVR. This is critical to preclude airspeed bleedoff and to accelerate to single-engine approach or safe go-around airspeed. As the throttles are advanced, the primary method of controlling yaw is to apply rudder into the good engine. Banking into the good engine will reduce the amount of rudder required and enhance single-engine climb performance. The aircraft should be controllable down to stall speed, if rudder and bank are correctly applied, but it is best to maintain or accelerate to single-engine airspeed above 150 KIAS (climb capability permitting). If altitude permits, maintaining a descent will allow more rapid acceleration.

If the pilot elects to go-around, the throttles should remain at MAX until at a safe altitude and airspeed. Gear retraction should be accomplished promptly once committed to the go-around, to enhance performance and to take advantage of any residual hydraulic pressure. Jettison of heavyweight stores will significantly improve climb performance. Fully retracting the flaps will increase single-engine climb performance, but will also decrease stall margin at low airspeed. Therefore, if climb performance allows, full retraction should be delayed until above 150 KIAS. Accelerate and climb straight ahead if terrain permits. If turns are necessary, they should be made into the good engine, if possible, and at minimum practical bank angle.

If landing is assured at the time of an engine failure or fire indication, the pilot should apply power as required, retract the speed brakes, and devote full attention to completing the landing. After touchdown, primary attention should be on restoring braking (if necessary), maintaining directional control, and safely stopping the aircraft. As time and circumstances permit, engine fire or shutdown procedures should be accomplished.

LANDING EMERGENCIES (CONT)

1. RUDDER — CONTROL YAW.

WARNING

- During single-engine operation, failure to use sufficient rudder can result in large sideslip angles and yaw rates. It is possible to create a condition where the yaw rate becomes so high that there is insufficient rudder available to correct it, and the aircraft will depart controlled flight.

NOTE

- Following engine failure, the associated rudder will revert to manual control when hydraulic pressure bleeds off. Total rudder effectiveness is slightly degraded and pedal force requirements are noticeably higher.
- In visual meteorological conditions, yaw control is best accomplished by using rudder to stop any nose excursions relative to outside visual cues. In instrument meteorological conditions, the pilot must use cockpit instruments (turn needle — centered and heading — stabilized) to determine when sufficient rudder is being applied.

2. THROTTLES — MAX.

WARNING

- On [8] [45], if the throttle of the bad engine is retarded to IDLE, crossbleed air from the good engine will be initiated when core rpm decreases below 56%, resulting in a 4% thrust loss.

3. SPEED BRAKES — CLOSE.

4. FLAPS — MVR.

NOTE

- Going from full flaps to MVR provides a significant decrease in drag without imposing a severe penalty in stall margin or available lift/climb potential. If MVR is selected promptly following left engine failure, residual hydraulic pressure will drive the flaps to the 7° position, which will allow subsequent full retraction using

EMER RETR. If complete left hydraulic pressure depletion has occurred prior to selecting MVR, the pilot must select EMER RETR to obtain flap aerodynamic retraction to less than 15°.

If go-around is necessary:

5. Gear — UP (if possible).
6. Stores — Jettison (if required).

WARNING

- The external 600-gallon fuel tanks are directionally destabilizing. Close pilot attention will be required to avoid rapid increases in sideslip. External tank jettison is highly recommended for both performance and handling considerations.
- Nonjettisonable ECM pods on outboard station will contribute to directional control problems if a counter balancing store on the opposite wing is jettisoned. This will be particularly evident if the ECM pod is on the same side as the failed engine. The overriding consideration must be aircraft performance. If single-engine climb capability is questionable, jettison is the only alternative.

NOTE

- Best single-engine performance is achieved with a slight bank (up to 5°) into the good engine and rudder, as required, to maintain a constant heading. The ball will be displaced toward the good engine, proportional to the amount of bank used.

At safe altitude and with airspeed above 150 KIAS (if possible):

7. Flaps — UP (EMER RETR if necessary).

WARNING

- If left hydraulic pressure is not available, the pilot must select EMER RETR. Use extreme caution to ensure the manual reversion switch is not inadvertently activated.

LANDING EMERGENCIES (CONT)

CAUTION

- During emergency situations, operation of the engine with the ENG FUEL FLOW switches in OVERRIDE will provide 15-20% more engine thrust. Operation of the engine in override should only be accomplished for the minimum time to achieve safe operating conditions. ITT should be reduced below 865°C for -100A engines and 830°C for -100 engines as soon as minimum safe altitude and rate of climb are achieved (estimate one to three minutes).
- Additional rudder input and bank will be required to control yaw when selecting OVERRIDE. The pilot should also anticipate an ENG HOT light illuminated and high ITT on the properly functioning engine.
- Operation for several minutes in OVERRIDE will not precipitate an immediate engine failure. However, ITT can reach 980°C and some engine durability degradation will occur. Operation in OVERRIDE for more than 15 minutes is not recommended.
- Engineering analysis determined that the aircraft will be controllable during single engine operations with T5 override. With an ECM pod on the same side as the nonoperating engine, approximately 40% rudder travel is still available for maneuvering the aircraft.

LANDING EMERGENCIES (CONT)

NOTE

- Best single-engine climb speed is a function of temperature, pressure altitude, gross weight, and configuration/drag index. The worst case occurs when a left engine failure precludes gear retraction and flaps can only be partially retracted (to less than 15° following emergency retraction). As a rule of thumb, best single-engine climb speed occurs at approximately 10 KIAS above normal approach speed (gear down, flaps partially retracted). From this baseline, best single-engine climb speed increases 10 KIAS with the gear retracted and another 10 KIAS when the flaps are fully retracted. Due to high rudder force requirements and increased yaw departure potential at low airspeeds, the pilot should attempt to maintain a climb speed in excess of 150 KIAS if possible. If a best single-engine climb speed below 150 KIAS must be maintained, it is essential that yaw rate be controlled through proper use of rudder and bank into the good engine. This will increase climb potential, as well as reducing the possibility of a yaw departure.

8. Accomplish ENGINE FAILURES/OVERTEMP or ENGINE FIRE procedure, as required.

If approach is continued:

5. Airspeed — Maintain 150 KIAS plus 1 knot for each 1,000 pounds of aircraft gross weight over 30,000 pounds.

6. Perform SINGLE-ENGINE LANDING procedure, and appropriate ENGINE FAILURES/OVERTEMP or ENGINE FIRE procedure as time and circumstances permit.

STUCK THROTTLE(S) LANDING

With a stuck throttle, close monitoring of fuel balance is required. If throttle(s) is/are stuck at a high power setting, the pilot has the option of landing with one or both engines operating, as needed to control airspeed. After landing with one throttle stuck at a high power setting, rudder will be required to control yaw induced by the difference in

thrust. The aircraft configuration for landing must also be considered for airspeed control. Engine shutdown can be accomplished using the corresponding fire handle. Time of shutdown varies, between 2 (from MAX) — 23 (from IDLE) seconds.

1. Control airspeed through configuration changes and/or engine shutdown.
2. Establish landing configuration.
3. Emergency brake handle — PULL (if left engine is shut down or stuck above IDLE power).

After touchdown:

4. Speed brakes — OPEN (if available).
5. Throttle(s) — OFF [operating engine(s) stuck above IDLE power — if possible].
6. Fire handle(s) — PULL [operating engine(s) stuck above IDLE power].

CAUTION

- If a fire handle is used to shut down an engine that is operating above IDLE power, a postshutdown overtemperature and/or tailpipe fire is possible. If the engine is operating at high power (above approximately 85% core RPM), a postshutdown overtemperature and/or tailpipe fire is likely. In either case, the pilot should alert fire department personnel, if time and conditions permit, prior to landing/shutdown.
- With the left engine shut down, nosewheel steering, normal braking, and anti-skid are not available. If the right engine is operating, the emergency brake system will provide unlimited brake applications. If both engines are shut down, at least five full brake applications should be available.

NOTE

- Engine core overtemperature or tailpipe fire (reported by outside observer) will not normally cause the engine fire warning light to come on. Extinguishing agent will not put out an engine core fire, as it does not discharge into the core. Extinguishing agent should be used if the fire light comes on or there are visual indications of an engine fire.

LANDING EMERGENCIES (CONT)

SINGLE-ENGINE LANDING

When faced with a single-engine landing, consideration must be given to aircraft gross weight, asymmetry, pressure altitude, and temperature. Checklist performance data is available to determine best single-engine climb speed. If level flight cannot be maintained at maximum power with stores on board, an early decision must be made as to which stores to jettison and where. The aircraft configuration should be cleaned up as much as possible. Use flap emergency retract or speed brake emergency retract, as required. A single-engine landing should be flown from a straight-in approach, with all maneuvering accomplished by a minimum of 2 - 3 nm from the touchdown point. A no-flap approach should be flown to ensure having a go-around capability.

Lowering the gear will result in an increase in drag, and must be compensated for by increasing power and increasing rudder opposing the failed engine. At 1 - 2 nm from the touchdown point, the fuselage should be aligned with the runway. Power reduction during the flare should be made slowly, and coordinated with a steady decrease in rudder to maintain nose alignment with the runway.

WARNING

- A combination of high gross weight, high pressure altitude, and high temperature may create a condition in which level flight is not possible with gear extended. In this case, delay lowering gear until ready for descent on final and, if possible, reduce weight prior to starting approach.
- During single-engine operations, failure to use sufficient rudder, especially during maneuvering turns, can result in large sideslip angles and yaw rates. It is possible to create a condition where the yaw rate becomes so high that there is insufficient rudder available to correct it, and the aircraft will depart controlled flight.

With the loss of a hydraulic system, rudder forces will be higher than normal and total rudder authority will be degraded. Rudder forces required to align the

fuselage with the runway can be extreme under conditions of high power setting and high crosswind into the dead engine. The following procedures may be used to minimize pilot fatigue:

- Flying a constant heading with a slight (up to 5°) bank angle into the good engine and sideslip toward the good engine (aircraft nose toward the dead engine) will reduce rudder force. The ball will be displaced toward the good engine, proportional to bank angle.
- Fly the approach with the crosswind from the operating engine side, if possible. In this case, crab angle (due to crosswind) and sideslip angle (due to asymmetric thrust) cancel each other out and require minimum rudder effort. The differences in technique between approach and landing with a crosswind from the dead engine side versus operating engine side are significant, and preplanning is essential.
- Fly a relatively steep approach (3°) to minimize power on the operating engine. Rudder deflection to align the fuselage with the runway should be coordinated with power reduction during the flare.

NOTE

- If the left engine is inoperative, the gear must be lowered with the auxiliary landing gear extension handle. Nosewheel steering, normal wheel brakes, flaps, and anti-skid will not be available.
- If the right engine is inoperative, speed brakes will not be available and the slats will extend, producing an increase in drag.
- In situations where landing distance is critical, when landing is assured, begin a flare so as to touchdown at the speeds recommended in T.O. 1A-10A-1-1, and use available drag devices. Gust factor and crosswind corrections should be applied to touchdown airspeed, but are not applied to single-engine approach speed.

LANDING EMERGENCIES (CONT)

1. Speed brakes — Close.
2. Flaps — Retract.
3. External stores — Jettison (as required).

NOTE

- Selective jettison of stores on the same side as the dead engine will reduce rudder requirement.
4. Yaw trim control knob — Neutral.
 5. SAS/Anti-skid — Paddle OFF.
 6. Yaw SAS — Engage operable channel if hydraulic pressure for operable hydraulic system is normal, and yaw damping, trim and turn coordination is desired. (Do not engage pitch SAS.)
 7. Landing gear handle — DOWN. (If left hydraulic system is inoperative: AUX LG EXT han-

dle — Pull; when gear indicates safe: AUX LG EXT handle — Push in.)

8. Emergency brake handle — Pull (if left hydraulic system is inoperative).
9. Anti-skid switch — ANTI-SKID (if left hydraulic system is operative).
10. Review SINGLE-ENGINE GO AROUND procedure.

11. Fly no-flap approach at 150 KIAS plus 1 knot for each 1,000 pounds of aircraft gross weight over 30,000 pounds until landing is assured.

After landing is assured:

12. Flaps — As required (if left hydraulic system is operative).
13. Speed brakes — As required (if right hydraulic system is operative).

LANDING EMERGENCIES (CONT)

SINGLE-ENGINE GO-AROUND

The following procedures should be used when required to execute a go-around from a single-engine approach.

1. Rudder — Control Yaw.
2. Throttle — MAX.
3. Landing gear — UP (if left hydraulic system available).
4. Stores — Jettison (if required).

NOTE

- Best single-engine climb speed is a function of temperature, pressure altitude, gross weight, and configuration/drag index. As a rule of thumb, under normal single-engine approach conditions (gear down, flaps up, stores previously jettisoned or of minimal consequence in regard to drag/gross weight) best single-engine climb speed is approximately 10 KIAS less than single-engine approach speed. From this baseline, best single-engine climb speed increases 10 KIAS when the gear is retracted. Due to high rudder force requirements and increased yaw departure potential at low airspeeds, the pilot should attempt to maintain a climb speed in excess of 150 KIAS if possible. If a best single-engine climb speed below 150 KIAS must be maintained, it is essential that yaw rate be controlled through proper use of rudder and bank into the good engine. This will increase climb potential as well as reducing the possibility of a yaw departure.

MANUAL REVERSION LANDING

Fly a shallow approach ($1\ 1/2^\circ - 2^\circ$), and fly aircraft onto the runway, observing sink rate limitations. Pitch response becomes extremely degraded in ground effect below 50 feet AGL. The aircraft will touch down firmly and the nose gear will drop rapidly to the runway. Pitch trim is not recommended for flaring the aircraft due to the possibility of overcontrolling pitch attitude. Two engine crosswind limit is 20 knots.

A single-engine manual reversion approach and landing should be attempted only under ideal conditions, and leaves little margin for error. A relatively steep approach should be made ($3 - 3\ 1/2^\circ$) with minimum power on the good engine. Use applicable techniques as described under SINGLE-ENGINE LANDING procedure. Start the flare at 200 feet AGL to arrest the sink rate and place the aircraft onto a shallow flight path for landing. Crosswind limit is 10 knots for single-engine, clean configuration. Asymmetric stores should be jettisoned prior to a manual reversion approach and landing.

1. Make straight in approach.
2. Ferry tanks — Jettison.
3. Extend landing gear.
 - a. Landing gear handle — Down.
 - b. AUX LG EXT handle — Pull.
 - c. AUX LG EXT handle — Push in (when landing gear indicates safe).
4. Emergency brake handle — Pull.

LANDING EMERGENCIES (CONT)

5. Hold 140 KIAS plus 2 knots per 1,000 pounds above 30,000 pounds until landing is assured (two engines running). For a single-engine manual reversion landing, hold 150 KIAS plus 2 knots per 1,000 pounds above 30,000 pounds until landing is assured.

WARNING

- Single-engine MRFCs minimum control speed is 130 KIAS.
- Manual reversion landing with an ECM pod on Station I or II is not recommended in gusty wind conditions, due to marginal roll authority/capability.
- Single-engine manual reversion landing with an asymmetry equivalent to an ECM pod on the same side as the dead engine is not recommended. Selectively jettison other ordnance to regain symmetry or to get the asymmetry (weapons load) to favor the side of the good engine. In any case, perform a controllability check prior to attempting to land.
- A successful single-engine manual reversion go-around is very difficult to accomplish and an early decision must be made.

UNSAFE GEAR DOWN INDICATION

Maintain airspeed below 200 KIAS.

1. Signal lights switch — BRT.
2. Signal lights lamp test button — Depress.

NOTE

- Each indicator has two bulbs. If test indicated that both bulbs are inoperative, the bulbs from less essential indicators such as the TAKEOFF TRIM, MARKER BEACON, or GUN READY can be used as replacements.

3. LAND GEAR circuit breaker — Recycle, open to close.

4. Check for damage and gear position. Use any means possible (visual, wingman, tower, etc.)

NOTE

- Electrical circuits to the landing and taxi lights are interlocked to insure operation only when the nose gear is down and locked.

5. Airspeed — Increase to 200 KIAS and pull g's and/or yaw aircraft. If landing gear remains unsafe, perform LANDING GEAR ALTERNATE EXTENSION procedure.

LANDING GEAR ALTERNATE EXTENSION

1. Airspeed — 200 KIAS or below.
2. LAND GEAR circuit breaker — Open (if left hydraulic system pressure is available).
3. Landing gear handle — Down (if possible).
4. AUX LG EXT handle — Pull.

CAUTION

- Minimize use of flight controls and flaps whenever the auxiliary landing gear extension handle is in the out position and left hydraulic system pressure is present to avoid left hydraulic system pump cavitation.

Reflects TO 1A-10A-1SS-73 dated 30 September 1988.

LANDING EMERGENCIES (CONT)

GEAR SAFE

If the landing gear indicates down and locked:

5. AUX LG EXT handle — Push in.
6. Emergency brake handle — Pull (nosewheel steering, anti-skid, and normal braking will not be available).

CAUTION

- If landing gear failed to extend normally with left hydraulic system pressure available, and the alternate extension is successful, the landing gear control valve may be stuck in the neutral position or receiving an improper up signal. Leave the LAND GEAR circuit breaker open. Normal brakes, nosewheel steering, and anti-skid will not be available, and emergency brakes must be used. There is no indication to the pilot if the valve has failed.

7. Monitor right hydraulic system pressure and land.

GEAR UNSAFE

If landing gear does not appear fully down or appears fully down but indicates unsafe:

5. Airspeed — Increase to 200 KIAS, induce positive/negative g's and/or yaw/roll moments.

If landing gear indicates safe, refer to GEAR SAFE procedures

ALL GEAR REMAIN UP

If all landing gear remain full up:

6. AUX LG EXT handle — Push in.
7. LAND GEAR circuit breaker — Close (15 Seconds after stowing AUX LG EXT handle).

CAUTION

- Allow at least 15 seconds between stowing AUX LG EXT handle and closing breaker, to avoid hydraulic pump cavitation.
8. LAND GEAR handle — Up. (If handle will not go up, use downlock override.)

9. Cycle LAND GEAR circuit breaker — open then closed.

10. LAND GEAR handle — Down. (It may be necessary to repeat steps 8 thru 10.)

GEAR STILL NOT DOWN

If the landing gear still does not appear fully down:

6. Perform LANDING WITH GEAR NOT DOWN procedure.

GEAR DOWN, BUT INDICATE UNSAFE

If all landing gear appear fully down, but indicate unsafe:

6. Restore landing gear/brake system to normal operation.
 - a. Landing gear handle — Check down.
 - b. AUX LG EXT handle — Push in.
 - c. LAND GEAR circuit breaker — Close (15 seconds after stowing AUX LG EXT handle).

CAUTION

- Allow at least 15 seconds between stowing the auxiliary landing gear extension handle and closing the LAND GEAR circuit breaker, to avoid hydraulic pump cavitation.
 - d. Emergency brake handle — Push in (if left hydraulic system pressure is available).
 - e. Anti-skid switch — ANTI-SKID (if left system pressure is available).
- 7. If no damage is apparent and left hydraulics are normal, recycle landing gear as a last resort.

CAUTION

- Do not cycle a damaged landing gear.

LANDING EMERGENCIES (CONT)

NOTE

- External stores should be jettisoned to reduce gross weight, except for those which would afford aircraft protection, e.g., empty fuel tanks, inert stores, TERs, etc. Before landing: lower helmet visor, lock the shoulder harness, and stow loose items.
8. Fly straight-in approach.

NOTE

- Land at the lightest practical gross weight, with an airspeed that provides good control and minimum sink rate touchdown. Barrier cables in the landing area should be removed.
9. After landing, stop straight ahead.
10. Maintain idle power on left engine while landing gear pins are installed.

WARNING

- Landing gear pins can be installed when the gear is not locked down. If groundcrew determines that drag strut (actuator) inner piston shows more than 1/4 inch . The gear is not locked down and jacks must be installed prior to left engine shutdown.

Reflects TO 1A-10A-1SS-73 dated 30 September 1988.

LANDING EMERGENCIES (CONT)

LANDING WITH GEAR NOT DOWN

If any landing gear does not appear fully down after performing the **UNSAFE GEAR DOWN INDICATION** and **LANDING GEAR ALTERNATE EXTENSION** procedures:

1. Have arresting gear cables removed from landing area.
2. If possible, retract landing gear as follows:
 - a. AUX LG EXT handle — Push in.
 - b. LAND GEAR circuit breaker — Close (15 seconds after stowing AUX LG EXT handle).
 - c. Landing gear handle — Up.
3. Jettison armament (retain empty tanks, racks, and inert stores).
4. Burn off excess fuel.
5. Flaps — 20° (if possible).
6. Lower visor, lock shoulder harness, and stow loose items.
7. If all gear are up, perform ALL GEAR UP procedure; otherwise, place gear handle down and refer to procedures for appropriate configuration.

ALL GEAR UP

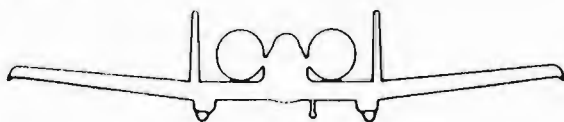

1. Speed brakes — Close.
2. Fly shallow approach at 15.5 units AOA.
3. Touch down at 15.5 units.

NOSE GEAR SAFE, BOTH MAINS UNSAFE

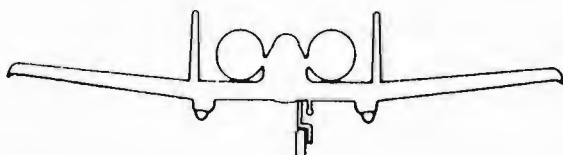

1. Speed brakes — As required (if available).
2. Fly power on approach at 21.5 units AOA.
3. Touch down at minimum sink rate.

NOSE GEAR SAFE, AND ONE MAIN GEAR SAFE

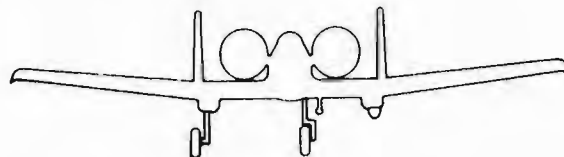

1. Emergency brake handle — Pull.
2. Speed brakes 30 - 40% (if available).
3. Fly shallow approach at 15.5 units AOA.
4. Land on side of runway that extended gear is on and touch down at minimum sink rate.
5. Hold wing up as long as possible.

NOSE GEAR UNSAFE, ONE OR BOTH MAINS SAFE

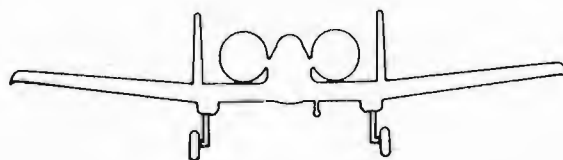

OR

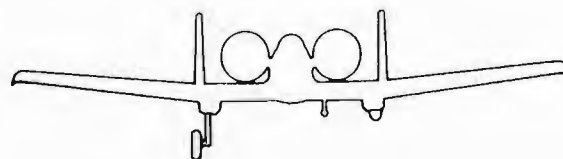

1. Emergency brake handle — Pull.
2. AUX LG EXT handle — Pull.
3. Attempt to lock nose gear — 250 KIAS, pull g's, and induce roll and/or yaw; if necessary, 300 KIAS, pull g's, and/or induce roll and/or yaw.

Reflects TO 1A-10A-1SS-73 dated 30 September 1988.

LANDING EMERGENCIES (CONT)

If not successful and full flaps are available:

4. Reduce weight below 29,000 pounds, induce aft cg by crossfeed and expending ammo and stores if possible. If weight cannot be reduced below 29,000 pounds, eject.

a. With more than 1,050 pounds of ammo/casings, land at 14 units AOA.

b. With less 1,050 pounds of ammo/casings, land at 16 units AOA.

NOTE

- Use the following weight figures to compute the ammo/casing weight:
Live rounds — 1.5 pounds each
Empty casings — 0.4 pounds each

If not successful and flaps not available:

4. Reduce weight below 28,000 pounds, induce aft cg by crossfeed and expending ammo and stores if possible. If weight cannot be reduced below 28,000 pounds, eject.

a. With less than 375 pounds of ammo/casings, fuel can be evenly distributed.

b. With more than 375 pounds of ammo/casings, aft fuel must exceed forward fuel by 1,000 pounds. Gross weight should be at an absolute minimum.

NOTE

- Use the following weight figures to compute the ammo/casing weight:
Live rounds — 1.5 pounds each
Empty casings — 0.4 pounds each
- If fuel cannot be distributed properly, ejection is recommended.

c. Land at 18 units AOA (not less than 135 KIAS).

At touchdown:

5. Throttles — IDLE.
6. Lower nose to runway promptly but gently.

NOSEWHEEL COCKED

If the nosewheel cocks, it will probably caster straight ahead after nosewheel touchdown.

1. Pull g's to extend nosewheel strut.
2. After touchdown, lower nosewheel slowly to runway.

NOTE

- Engaging nosewheel steering immediately after main gear touchdown may center the nosewheel. However, this method is not recommended when large rudder inputs are required due to strong crosswind conditions.

BLOWN TIRE

1. Anti-skid — OFF (blown main).
2. Land on the side of the runway away from the malfunction.
3. Use rudder, nosewheel steering, and brakes to maintain directional control.

Reflects TO 1A-10A-1SS-73 dated 30 September 1988.

CAUTION LIGHT ANALYSIS

LIGHT	CONDITION	CORRECTIVE ACTION
AIL, L/R	Respective aileron jammed.	Position aileron emergency disengage switch toward affected jam indicator light and monitor AIL DISENG caution light. Refer to AILERON/ELEVATOR CONTROL JAMS procedure.
AIL DISENG	Either aileron is disengaged from the control stick at the disconnect unit.	Placing the aileron emergency disengage switch to the center position will rearm the disconnected control to reengage the control stick. If necessary, move stick in roll to achieve alignment of disconnecter elements so that reengagement can occur.
AIL TAB, L/R	Advises when the roll servo tab shift actuator has extended.	Advisory only in MRFCS. In powered flight control system, refer to FAILURE TO SHIFT OUT OF MANUAL REVERSION procedure.
ANTI-SKID	Indicates <ol style="list-style-type: none"> 1. Anti-skid switch OFF and landing gear handle in down position, or 2. When switch is ON, failure in anti-skid circuit. 	<ol style="list-style-type: none"> 1. Anti-skid switch – ON. 2. Anti-skid switch – OFF (refer to NORMAL BRAKE/ANTI-SKID failure).
APU GEN	APU generator off line with APU generator switch in PWR.	Reduce electrical load and attempt to reset the generator by momentarily placing the APU GEN switch in OFF/RESET, then returning to PWR. If malfunction was transitory, the APU GEN caution light will go out.
BLEED AIR LEAK	Temperature sensitive conductor adjacent to bleed manifold senses a bleed air leak.	Turn bleed air switch OFF. Refer to BLEED AIR LEAK/SERVICE AIR OVERHEAT procedure.
CADC	CADC failure.	Monitor pitot-static airspeed indicator and select STBY or PNEU on altimeter. Deselect mode C on IFF.

Figure 3-9. (Sheet 1 of 5)

CAUTION LIGHT ANALYSIS (CONT)

LIGHT	CONDITION	CORRECTIVE ACTION
CONV, L/R	Failure of indicated converter.	Check L CONVERTER and AUX ESS BUS TIE circuit breakers closed. Refer to CONVERTER FAILURE procedure.
ELEV, L/R	Respective elevator jammed.	Position elevator emergency disengage switch toward affected jam indicator light, and monitor ELEV DISENG caution light. Refer to AILERON/ELEVATOR CONTROL JAMS procedure.
ELEV DISENG	Either elevator is disengaged from the control stick at the disconnect unit.	Placing the elevator emergency disengage switch to the center position will rearm the disconnected control to reengage the control stick. If necessary, move stick in pitch to achieve alignment of disconnecter elements so that reengagement can occur.
ENG HOT, L/R	ITT indicator is exceeding 835°C/ 91 880°C	Retard throttle to the setting at which ITT decreases to within normal limits. If necessary, shut down engine.
ENG OIL PRESS, L/R	Oil pressure is below 30 psi.	Retard throttle to IDLE. If minimum oil pressure of 30 psi cannot be maintained, place affected throttle to OFF. Refer to ENGINE OIL SYSTEM MALFUNCTION procedure.
ENG START CYCLE	Light remains on after starting cycle.	On ground – APU/external – OFF. Throttles – OFF. In air – Open engine start L and R circuit breakers. If a subsequent air start becomes necessary, ensure appropriate circuit breaker is closed.
	Air turbine start solenoid valve is open, due to throttle positioned at IDLE (engine speed below 56%) or the engine operate switch is in MOTOR.	Advisory.

Figure 3-9. (Sheet 2 of 5)

CAUTION LIGHT ANALYSIS (CONT)

LIGHT	CONDITION	CORRECTIVE ACTION
FUEL PRESS, L/R	Fuel differential pressure is low. Indicates possible boost pump failure, or if boost pump caution light is not on, a failure or clog in the engine feed line.	Crossfeed switch to CROSSFEED; if light stays on, crossfeed switch OFF. Check for fuel leak. Refer to FUEL PRESSURE LOW procedure for additional information. To ensure that the aircraft cg remains within established limits, the left main (aft) tank fuel should not exceed the right main (forward) tank fuel by more than 1,000 pounds.
GEN, L/R	Indicated AC generator off line, or AC generator in OFF/RESET.	Check generator control circuit breaker. Attempt to reset by momentarily placing associated generator switch in OFF/RESET, then returning it to PWR. If malfunction was transitory, the generator caution light will go out. If the generator will not reset after 3 attempts, position the generator switch to OFF/RESET for the remainder of the flight. Refer to GENERATOR FAILURE procedure.
GUN UNSAFE	Comes on when the trigger is released if clearing cycle is not completed within 2.5 seconds. Live rounds are in the barrel and the gun could fire.	If the GUN UNSAFE light comes on and remains on, proceed as follows: <ol style="list-style-type: none"> 1. Gun rate switch — SAFE 2. Master arm switch — SAFE 3. Do not reattempt to fire the gun (if cause cannot be isolated and corrected).
HARS	Loss of HARS.	Navigation mode select panel — NAV CRS or MAN (if INS is operative). HARS/SAS override switch — OVERRIDE for yaw damping (if INS is inoperative). Refer to HARS MALFUNCTION procedure.
HYD PRESS, L/R	Indicated hydraulic system pressure is below 900(± 100) psi. Flight control mode switch — MAN REVERSION.	Monitor hydraulic pressure gauge and equipment operated by the affected hydraulic system. Refer to LEFT/RIGHT HYDRAULIC SYSTEM FAILURE procedure. Advisory only.

Figure 3-9. (Sheet 3 of 5)

CAUTION LIGHT ANALYSIS (CONT)

LIGHT	CONDITION	CORRECTIVE ACTION
HYD RES, L/R	Quantity of hydraulic fluid is low.	Land when practical. Refer to HYDRAULIC SYSTEMS MALFUNCTIONS procedure.
IFF MODE-4	Inoperative Mode 4 capability, such as Mode 4 codes zeroized, transponder failure, faulty computer.	Avoid operation in a known Mode 4 interrogating environment. If already in one, take appropriate emergency or corrective action.
INERTIAL NAV	INS attitude channel failure (ADIATT or ATT visible on CDU display line 2).	INS will automatically switch to HARS. HARS Δ comes on and ADI and HSI flags out of view. Set CDU mode selector knob to OFF and select HARS if automatic switch-over has not occurred.
	INS navigation or heading failure (NAV and/or HUDATT visible on CDU display line 2).	CDU — Select ATTD or NAV mode select panel — select HARS. When HARS is selected, HARS Δ comes on and HSI power off flag is out of view.
INST INV	AC essential and auxiliary AC essential busses are not receiving AC power. Possible failure of the instrument inverter.	Place the inverter switch in TEST to remove any AC power to the AC essential bus. If system is normal, the INST INV caution light will show either a momentary light or will go out. If the light remains on, the inverter or change-over circuit has failed. Refer to INVERTER FAILURE procedure.
INU AIR HOT	Loss of INU cooling air.	Monitor INS operation. If INS operation is abnormal, turn CDU mode selector to OFF.
L-R TKS UNEQUAL	Imbalance of 750 (\pm 250) pounds of fuel is sensed between two main fuselage tanks.	Verify fuel quantity at fuel quantity indicator. Balance fuel through use of boost pump switches, crossfeed switch and/or tank gate switch. Refer to L-R TANKS UNEQUAL procedure.
MAIN FUEL LOW, L/R	Fuel quantity in indicated tank is approximately 500 pounds.	Verify indicated fuel tank quantity indicator. Crossfeed switch to CROSSFEED. If imbalance exists, place tank gate switch to OPEN, unless tank leakage is suspected. Refer to FUEL QUANTITY INDICATOR MALFUNCTION procedure.

Figure 3-9. (Sheet 4 of 5)

CAUTION LIGHT ANALYSIS (CONT)

LIGHT	CONDITION	CORRECTIVE ACTION
MAIN PUMP, L/R	Fuel pressure differential at outlet of indicated main fuel boost pump is low, indicating possible pump failure.	Crossfeed switch to CROSSFEED. Tank gate switch to OPEN as required to balance main tanks. Refer to MAIN BOOST PUMP FAILURE procedure.
OXY LOW	0.5 liter, or less, liquid oxygen remains in the oxygen converter.	<ol style="list-style-type: none"> 1. Descend to 10,000 feet MSL or below if possible. 2. Activate emergency oxygen supply (if required). 3. Land as soon as practical.
PITCH SAS	One or both pitch SAS channels disengaged.	If only one hydraulic power source is available, both pitch SAS switches OFF. Refer to SAS MALFUNCTION procedure.
SERVICE AIR HOT	Indicates precooler output air temperature is excessive.	Bleed air switch OFF. Refer to BLEED AIR LEAK/SERVICE AIR OVERHEAT procedure.
STALL SYS	Power failure in the Alpha/Mach computer. Peak performance/stall warning tones inoperative. Slats should open automatically.	<ol style="list-style-type: none"> 1. AOA -- 21.5 units/ 110 20.0 units or less until landing. <p>If stall or peak performance tones on continuously:</p> <ol style="list-style-type: none"> 2. SPS & RUDDER AUTH LIMIT circuit breaker — Open.
WINDSHIELD HOT	Windshield anti-icing electrical circuit temperature is in excess of 150°F, or aircraft is on battery power only.	Windshield defog/defice switch OFF. Rain removal switch OFF.
WING PUMP, L/R	Fuel pressure differential at outlet of indicated wing fuel boost pump is low, indicating possible pump failure.	Crossfeed switch to CROSSFEED. Monitor all fuel tanks. Refer to WING BOOST PUMP FAILURE procedure.
YAW SAS	One or both yaw SAS channels disengaged.	If only one hydraulic power source is available, engage operable SAS channel if YAW trim and yaw damping are desired. Refer to SAS MALFUNCTION procedure.

Figure 3-9. (Sheet 5 of 5)

CDU SYSTEM STATUS MESSAGES

MESSAGE	CONDITION	CORRECTIVE ACTION
ADIATT (Line 2)	Analog attitude data is invalid.	Select HARS.
HUDATT (Line 2)	INU digital pitch, roll, and azimuth data is invalid.	Select HARS.
ATT (Line 2)	Analog and digital pitch, roll, and azimuth data is invalid.	Select HARS.
CADC (Line 2)	Air data is invalid.	Cross check caution light panel.
MBC (Line 2)	MBC has failed.	If master caution light is on, select HARS.
NAV (Line 2)	Navigation processing has failed. INU digital data invalid.	Select HARS.
VV (Line 2)	INS vertical velocity data is invalid.	Disregard HUD vertical velocity and TVV.
ATTD (Line 6)	INU is in attitude mode due to operator selection, INU digital data invalid, or INS communication failure.	Select HARS if ATTD not selected.
CDU FAIL (Line 6)	CDU hardware failure.	Select HARS.

General Notes:

1. During power transfers or interruptions, momentary indication of CADC should be disregarded.
2. If INS HUD information disappears for any reason, HUD must be turned OFF and back on to regain INS data.
3. The CDU automatically reverts to the test page if INU data is not received. The page selector will not work and the test page cannot be removed. CDU – OFF.

Figure 3-10

SECTION IV
CREW DUTIES

Not Applicable

SECTION V

OPERATING LIMITATIONS

TABLE OF CONTENTS

Operating Limitations	5-1	Prohibited and Restricted Maneuvers	5-8
Instrument Markings	5-1	Airspeed Limitations	5-8
General Restrictions	5-1	Acceleration Limitations	5-8A
Flight Restrictions	5-5	Weight Limitations	5-9
Instrument Meteorological Conditions	5-5	Asymmetrical Load Moment Limitations	5-9
Brake Limitations	5-5	Sink Rate Limitations	5-9
Engine Limitations	5-7	Center-of-Gravity	5-9
APU Limitations	5-7	External Stores Limitations	5-9

OPERATING LIMITATIONS

This section specifies aircraft and engine limitations to be observed during normal operation of the aircraft. They are derived from actual flight tests and demonstrations. The most restrictive limitation applies to any given condition. Limitations that are merely associated with a certain technique or specialized phase of operation are discussed appropriately in other sections of the manual.

INSTRUMENT MARKINGS

The limitations that must be observed for safe and efficient operation of the aircraft and engine are shown in figure 5-1, Instrument Markings. When necessary, further explanation of the instrument markings is covered in the text of this section under the appropriate heading.

GENERAL RESTRICTIONS

1. Do not deploy the speed brakes while rolling the airplane at speeds above 350 KIAS.
2. Do not operate pitot heat system for more than 6 minutes while on the ground.
3. Practice elevator and aileron emergency disengagements are not authorized during flight.
4. Canopy restrictions while taxiing:
 - a. Canopy must be closed and locked if the total effective headwind velocity/force against the canopy while taxiing is in excess of 50 knots.
 - b. Canopy must not be actuated while turning.
5. ECM pod operations/checkouts should be kept to a minimum time on the ground. Operation of the ECM pods on the ground should not be accomplished if only one engine generator is functioning.

INSTRUMENT MARKINGS **BASED ON JP-4 FUEL**



INTERSTAGE TURBINE TEMPERATURE

— LINE 830°C / [9] 865°C

- STABILIZED TEMP ABOVE 830°C / [9] 865°C INDICATES AN ENGINE MALFUNCTION. DAMAGE TO ENGINE MAY HAVE OCCURRED.
- TRANSIENT OPERATION UP TO 860°C / [9] 900°C FOR NO MORE THAN 12 SECONDS DURING STARTING OR DURING ACCELERATION IS ACCEPTABLE.

— BAND 275 - 830°C / [9] 865°C

NORMAL RANGE

CAUTION

- Stabilized idle ITT above 675°C could indicate a failing outer transition liner; abort.



CORE SPEED

— LINE 102%

- NO OPERATION ABOVE LINE

— BAND 100 - 102%

- MAXIMUM 3 SEC WITHIN BAND

— BAND 56 - 100%

- NORMAL RANGE

CAUTION

- Idle RPM below computed minimum indicates possible CIT sensor failure; abort.



**OIL PRESSURE
STEADY STATE LIMITS**

— LINE 95 PSI

- MAXIMUM ALLOWABLE

— BAND 55 - 95 PSI

- NORMAL RANGE - CORE RPM IDLE TO MAX

— BAND 40 - 55 PSI

- ACCEPTABLE RANGE CORE RPM IDLE - 85%

— LINE 40 PSI

- MINIMUM FOR NORMAL IDLE OPERATION

30 PSI

- DO NOT OPERATE BELOW

FLUCTUATION LIMITS

±5 PSI WITHIN STEADY STATE LIMITS WITH INTERMITTENT FLUCTUATIONS ALLOWABLE TO ±10 PSI FOR A MAXIMUM OF 2 SECONDS

NOTES:

- ENGINE OIL PRESSURE MAY BE ERRATIC DURING AIRCRAFT MANEUVERS, DURING ZERO "G" AND NEGATIVE "G" FLIGHT OIL PRESSURE WILL DROP TO ZERO. DURING POSITIVE "G" FLIGHT OIL PRESSURE MAY INCREASE. DURING YAWING MANEUVERS OIL PRESSURE MAY MOMENTARILY DROP BELOW THE GREEN BAND (55 - 95 PSI). THESE TRANSIENT CONDITIONS ARE ACCEPTABLE PROVIDED PRESSURE RETURNS TO WITHIN THE GREEN BAND (55 - 95 PSI) WITHIN 1 MINUTE AFTER RETURN TO STEADY-STATE, STRAIGHT AND LEVEL FLIGHT.
- OIL PRESSURE MAY PEG AT 100 PSI AFTER GROUND OR AIR START. IF PRESSURE DOES NOT DECREASE TOWARD NORMAL AFTER A MAXIMUM OF 2.5 MINUTES, SHUT DOWN ENGINE.

Figure 5-1. (Sheet 1 of 3)

INSTRUMENT MARKINGS (CONT)



FAN SPEED

 LINE 100%

 BAND 98 - 100%

 BAND 22 - 98%

- OPERATION ABOVE THIS SPEED COULD RESULT IN ENGINE DAMAGE. OVER SPEED INSPECTION REQUIRED.
- STEADY STATE SPEEDS IN THIS BAND INDICATE AN ENGINE MALFUNCTION.
- NORMAL RANGE: IDLE - MAXIMUM

- NOTE**
- REFER TO T.O. 1A-10A-1-1 FOR PREDICTED TAKEOFF FAN SPEED.
 - FAN SPEED SHOULD BE CHECKED DURING MAXIMUM POWER TAKEOFFS AT APPROXIMATELY 1,000 FEET ON THE TAKEOFF ROLL.
 - THE 1% BELOW MINIMUM TRIM AUTHORIZED FOR SELECTED TF34-GE-100 ENGINES, SHALL NOT BE A FACTOR WHEN COMPUTING TAKEOFF FAN SPEED.

2% REDUCTION BELOW PREDICTED TAKEOFF FAN SPEED AT MAX POWER, WRITE UP ON AFTO FORM 781.
3% REDUCTION BELOW PREDICTED TAKEOFF FAN SPEED AT MAX POWER IS INDICATIVE OF MECHANICAL MALFUNCTION AND ABORT IS REQUIRED.

80% PREDICTED TAKEOFF FAN SPEED
EXAMPLE: 78% WRITE UP FAN SPEED
77% MECHANICAL MALFUNCTION INDICATED, ABORT

WARNING

FAN SPEEDS LESS THAN PREDICTED WILL RESULT IN REDUCED SINGLE-ENGINE RATE OF CLIMB, AND WILL ADVERSELY AFFECT OTHER TAKEOFF PARAMETERS. UNDER CRITICAL OPERATING CONDITIONS (SHORT RUNWAY, HIGH GROSS WEIGHT, HIGH TEMPERATURE, PRESSURE ALTITUDE, ETC.) AN ABORT MAY BE APPROPRIATE ACTION IF PREDICTED FAN SPEED CANNOT BE ACHIEVED.

INSTRUMENT MARKINGS (CONT)

FUEL FLOW



- BAND 150 - 4100
- LINE 150
- NORMAL RANGE
- DO NOT OPERATE BELOW

APU OPERATION

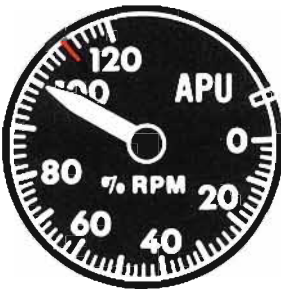

- 100(±3)% RPM NORMAL
- 110(±3)% RPM AUTOMATIC SHUTDOWN

STARTING LIMITS (UNDER 60% RPM)

- 980°C FOR TWO SECONDS



CONTINUOUS OPERATION

- 200 - 715°C NO LIMIT
- 760°C FOR TWO SECONDS (DURING ENGINE START)

HYDRAULIC PRESSURE



- LINE 3350 PSI
- BAND 2800 - 3350 PSI
- MAX PRESSURE
- NORMAL PRESSURE

Figure 5-1. (Sheet 2 of 3)

INSTRUMENT MARKINGS (CONT)



ACCELEROMETER

BASIC AIRCRAFT LOAD FACTOR LIMITATIONS

WEIGHT (APPROX)	SYM	ASYM
	30,000 LB	+7.33 -3.00
46,000 LB	+5.00 -2.00	+4.00 -1.00

NOTE

SEE FIGURE 5-3 (SHEET 3 OF 3) FOR LOAD FACTOR LIMITATIONS VS GROSS WEIGHT.

SEE FIGURE 5-8 FOR LIMITATIONS APPLICABLE TO SPECIFIC STORE CONFIGURATIONS: HOWEVER, IN NO CASE SHALL THE ALLOWABLE ASYMMETRIC LOAD FACTORS BE EXCEEDED.

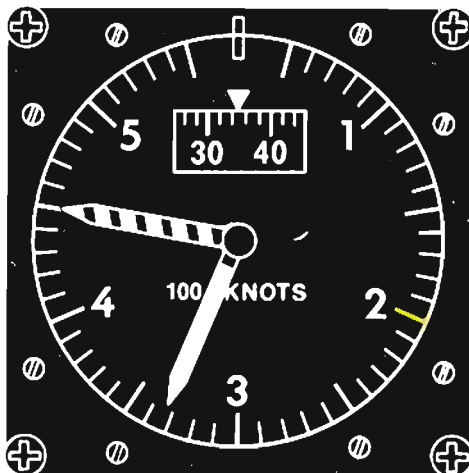

AIRSPEED

LINE 200 KNOTS LIMIT GEAR DOWN & FLAP DOWN SPEED. STRIPED POINTER WILL MOVE TO INDICATE LIMITING STRUCTURAL AIRSPEED.

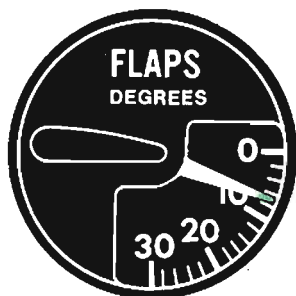

FLAP POSITION

LINE AT 7 DEGREES (MVR) POSITION

Figure 5-1. (Sheet 3 of 3)

FLIGHT RESTRICTIONS

FUEL IMBALANCE

With less than 300 rounds of ammunition remaining, or for configurations without ammunition but with ballast for the most aft cg limit, and an L-R TANKS unequal caution light on:

- Verify unequal fuel quantity utilizing fuel quantity gauge
- If imbalance is caused by more fuel remaining in the left (aft) tank, the aircraft should not exceed the airspeeds indicated below.

<u>Altitude (feet)</u>	<u>Speed (KIAS)</u>
Sea Level	315
15,000	240
35,000	156

CROSSWIND LANDING RECOMMENDATIONS

The following table lists the recommended limits of crosswind component velocities. The limits have been verified by flight test except as noted.

Operable Engine(s)	Operable Hydraulic Systems	Flaps	Configuration	
			Clean	Ferry
<u>Normal</u>				
2	2	20°	35 KTS	30 KTS
2	2	0°	35 KTS	25 KTS
<u>Single System</u>				
2/1	1	20°/0°	30 KTS	25 KTS
<u>Manual Reversion</u>				
2	0	0°	20 KTS	N/A (jettison)
1	0	0°	10* KTS	N/A (jettison)

* Actual landings not tested, data verified at altitude

NOTE

- Asymmetric store loadings, high gust conditions, and any adverse runway conditions must be evaluated by the pilot.

The aircraft has less directional stability in the ferry configuration, especially with the flaps up, and therefore the crosswind limits are lower. Other external stores loadings may exhibit a slight loss in directional stability, but the ferry configuration is considered the worst case. Full flap landings are recommended with external stores or fuel tanks. SAS off approaches and large wind gust velocities increase the pilot workload, but adequate control exists within specified limitations.

INSTRUMENT METEOROLOGICAL CONDITIONS

Flight into areas of known moderate or severe icing is not recommended.

BRAKE LIMITATIONS

Wheel brake energy limits are shown in figure 5-2. The brake cooling time required between landing and takeoff can be determined from this chart by using

WHEEL BRAKE ENERGY LIMITS (ONE CONTINUOUS BRAKE APPLICATION)

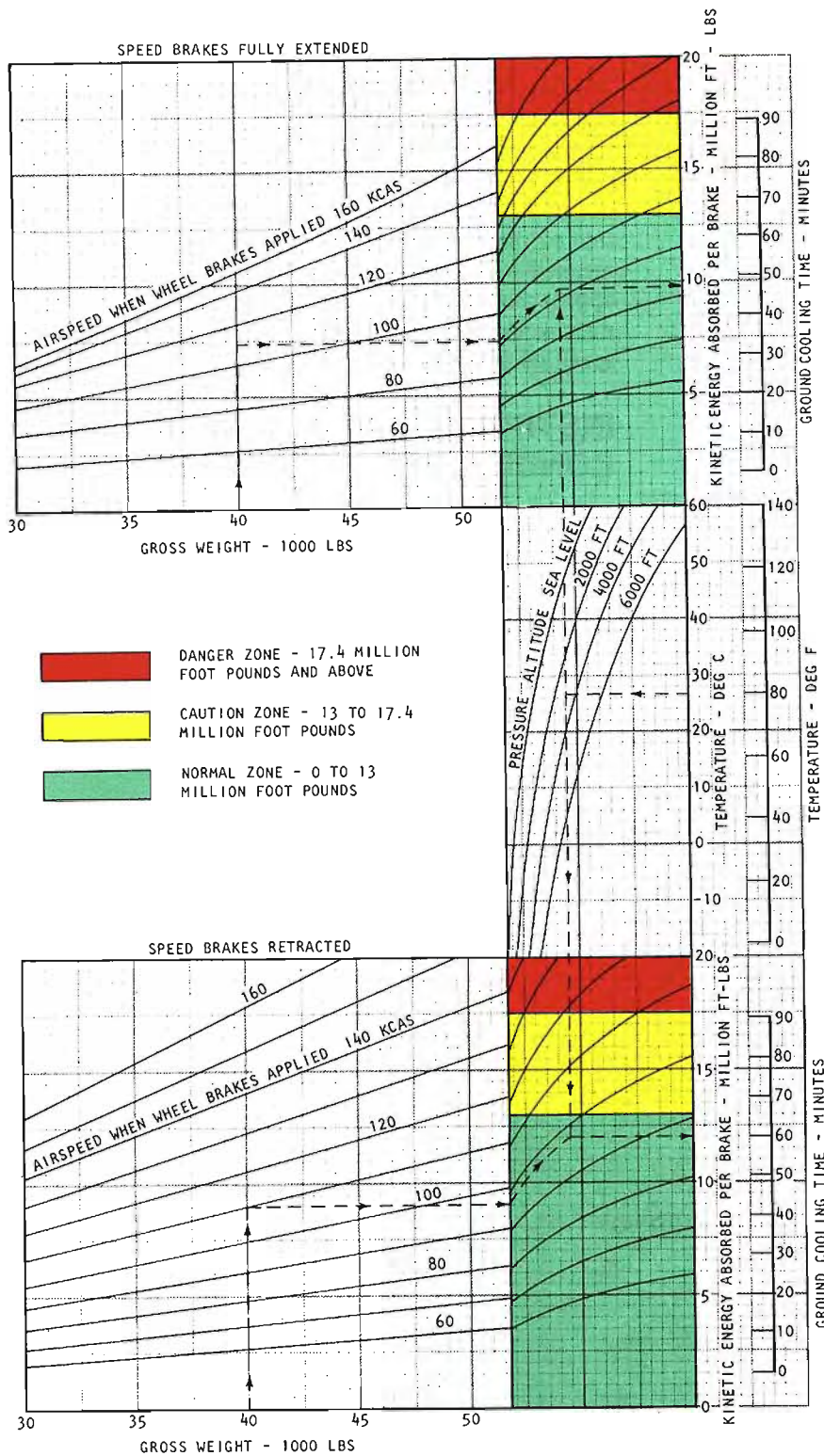

THE FOLLOWING INFORMATION EXPLAINS ACTION TO BE TAKEN WHEN A STOP IN THE DANGER, CAUTION OR NORMAL ZONE IS PERFORMED.

DANGER ZONE

1. Proceed to the nearest designated hot brake area on the ramp without stopping and as quickly as possible.
2. Request fire fighting equipment.
3. After engine shut-down, evacuate aircraft as soon as possible and leave immediate vicinity.

CAUTION ZONE

1. Clear active runway as tires may deflate.
2. Do not attempt subsequent takeoff or park in a congested area until brake housings have cooled and been inspected for brake damage.

NORMAL ZONE

Delay subsequent takeoff for times indicated on chart.

NOTE:

- AIRSPEED SHOULD BE CORRECTED FOR GROUND WIND COMPONENT.
- ALLOWANCE SHOULD BE MADE FOR LOW SPEED TAXI ENERGY AT A RATE OF 1 MILLION FOOT POUNDS PER MILE FOR WEIGHTS BELOW 40,000 LBS AND 1/2 MILLION FOOT POUNDS PER MILE FOR WEIGHTS GREATER THAN 40,000 LBS.

EXAMPLE: FULL STOP LANDING

GIVEN:
 GROSS WEIGHT = 40,000 LBS
 AIRSPEED WHEN BRAKES ARE APPLIED = 115 KCAS
 TOWER REPORTED WIND VELOCITY = 5 KNOT HEADWIND
 PRESSURE ALTITUDE = 3000 FEET
 OUTSIDE AIR TEMP 80°F

FIND:
 BRAKE ENERGY ABSORBED
 AND COOLING TIME REQUIRED

SOLUTION:
 FOLLOWING EXAMPLE LINES THE ENERGY ABSORBED IS 12 MILLION FOOT POUNDS PER BRAKE WHEN SPEED BRAKES ARE RETRACTED AND 9.8 MILLION FOOT POUNDS WHEN SPEED BRAKES ARE EXTENDED. COOLING TIME IS 60 MINUTES AND 48 MINUTES RESPECTIVELY.

Figure 5-2

aircraft speed, gross weight, and ambient air temperature. If hot brakes are suspected, do not attempt subsequent takeoff or park in congested area until brake housings have cooled and been inspected for brake damage.

ENGINE LIMITATIONS

Normal engine operating limitations are shown in figure 5-1. In the event of an overtemperature condition, the pilot should note the maximum temperature reached and the duration of the overtemp.

NOTE

- Engine operation should be conducted at the lowest power setting consistent with mission accomplishment to extend engine life.
- 94 If pilot suspects any engine problem or desires to take a frame of flight data, press TEMS DATA switch (below and left of the landing gear handle). Switch must be pressed for at least 1 second. Note the time and indications of related cockpit instruments for ground comparison. Perform Umbilical Display Unit — TEMS Status Check after flight for code(s).

MINIMUM IDLE SPEED
CORE PERCENT RPM LIMITS

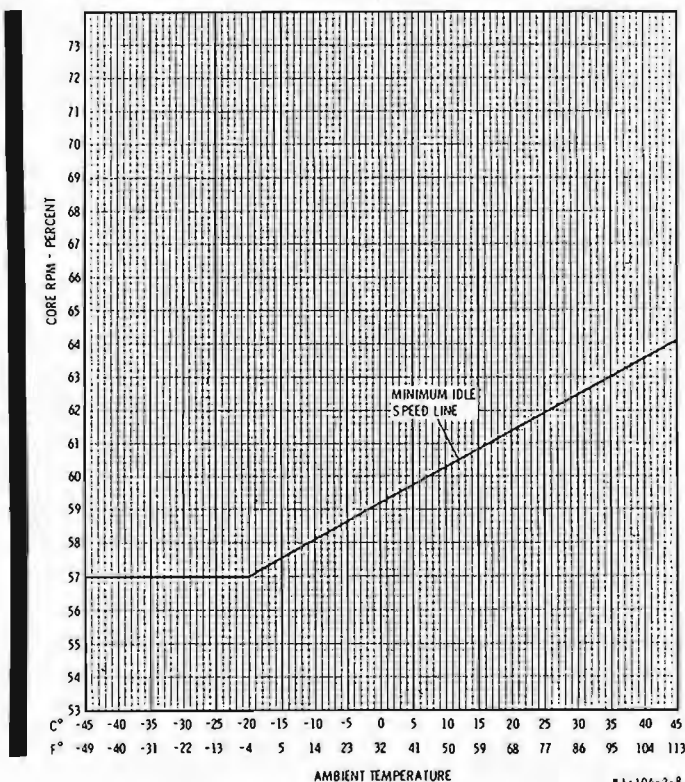

ENGINE STARTING LIMITATIONS

The starter is capable of making any number of consecutive start cycles with 60 seconds between cycles. In addition, the starter is limited to motoring the engine for a maximum of 2 minutes followed by a 5-minute rest period.

If light off does not occur after 20 seconds, retard throttle to OFF, dry-motor engine for 30 seconds, wait 1 minute, and reattempt start.

The engine should reach IDLE speed within 60 seconds after moving throttle to IDLE.

APU LIMITATIONS

UNSUCCESSFUL APU STARTS

Unsuccessful starts should be aborted by placing the APU switch in OFF. An unsuccessful APU start is defined as follows:

1. APU does not exceed 60% rpm within 30 seconds.
2. EGT does not decrease toward continuous operating range as rpm increases above 60% (hung start).

APU AIR OR GROUND STARTING

1. While on the ground, do not start the APU if there is visible fuel collected on the left engine nacelle.
2. During ground operation, 10 minutes must elapse between each initiation of successful start cycles.
3. During flight, a second start may be made 2 minutes after APU shutdown.
4. After an unsuccessful start, wait 1 minute for the APU to stop rotating and drain fuel before attempting another start.
5. Three unsuccessful attempts may be made followed by a 20 minute cool-down period prior to attempting another APU start.

APU OPERATION

Either on the ground or in the air, do not operate the APU for more than 5 minutes with the APU generator OFF. The APU generator is the only source of power for electric fan cooling of the APU hydraulic pump.

Wait at least 2 minutes after ENG START CYCLE light goes off before APU shutdown.

PROHIBITED AND RESTRICTED MANEUVERS

1. Zero or negative g maneuvers for more than 10 seconds are prohibited.
2. Intentional spins are prohibited.
3. If the pitch and/or yaw SAS is OFF, 360° rolls are restricted as follows:
 - a. Clean aircraft — 1g.
 - b. With external stores — not recommended.
4. Intentional transition and flight in MRFCS operating mode are limited to the following situations:
 - a. Response to emergency.
 - b. Acceptance flights.
 - c. Functional check flights (FCF) and other flights while observing the following restrictions:

	<u>TRANSITION</u>	<u>FLIGHT</u>
Airspeed	180 — 210 KIAS 180 — 280 KIAS (FCF only)	140 — 280 KIAS 140 — 325 KIAS (FCF only)
Altitude	10,000 FT AGL minimum	5,000 FT AGL minimum
G Load	1g	0 — (+) 4g
Attitude	Level flight	± 30° bank ± 20° pitch
cg	25 — 29.6% MAC	
Configuration	Flaps up	Flaps up
External stores	None, except symmetrical TERs, with or without BDU-33s	None, except symmetrical TERs, with or without BDU-33s

WARNING

- Trim malfunctions during transition to and in manual reversion mode, especially at higher air speeds, can result in control forces which exceed physical capability to counteract. Immediately before transition,

trim for level flight. Immediately after transition, check pitch trim operates in both directions before exceeding manual reversion transition speed limits. If pitch trim is inoperative/malfunctions, immediately return to normal flight mode.

- If either hydraulic pressure fails to drop during transition to manual reversion, immediately return to normal flight mode and do not attempt another transition.
- Aileron tab shifter malfunctions may result in unsatisfactory roll control for flight mode selected. If a tab fails to shift on selection of manual reversion mode, return to normal flight mode. If a tab fails to shift when returning to normal flight mode, the associated tab light will remain on. Roll control may be enhanced by disconnecting aileron associated with tab malfunction. Pulling applicable tab circuit breaker will restore roll trim, extinguish the tab light, and preclude roll oscillations due to subsequent tab shifting. Flight in manual reversion mode with one aileron disconnected has not been tested and may be impossible.
- Power reductions at high speed in manual reversion mode will cause severe pitch down. Make full use of available aft stick, nose up pitch trim, and return to normal flight mode before reducing power during recovery from high speed dives.

AIRSPEED LIMITATIONS

Refer to instrument markings illustration (figure 5-1).

1. With or without stores:
 - a. One or both hydraulic systems operative — 450 KIAS or Mach 0.75, whichever is lower.
 - b. Both hydraulic systems inoperative (manual reversion) — 390 KIAS or Mach 0.75, whichever is lower.
2. Maximum airspeed with landing gear and/or flaps extended is 200 KIAS.

WEIGHT LIMITATIONS

The maximum gross weight is 51,000 pounds. This weight limitation applies to towing, taxiing, takeoff, inflight, and landing.

With aircraft gross weight above 46,000 pounds, the aircraft is limited to gentle turns and braking during ground operations.

ASYMMETRICAL LOAD MOMENT LIMITATIONS

Maximum asymmetrical load moment is 27,168 foot-pounds. Distance in feet from fuselage centerline to pylon stations is as follows:

STATION	DISTANCE/FT
1 & 11	19.1
2 & 10	15.6
3 & 9	12.0
4 & 8	5.5
5 & 7	1.9

SINK RATE LIMITATIONS

The aircraft allowable sink rate for landing is 600 feet/minute for gross weights up to 33,200 pounds; the rate decreases linearly (approximately 14 feet/minute/1,000 pounds) to 354 feet/minute at 51,000 pounds.

CENTER-OF-GRAVITY

Refer to aircraft Weight and Balance Data, T.O. 1-1B-40.

EXTERNAL STORES LIMITATIONS

The external stores limitations charts (figure 5-8) depict the authorized types of suspension and store loadings. The symbols shown in figure 5-4 are used to indicate the type of suspension and the rack stations upon which stores are authorized for carriage and release. These symbols are also used in the example configurations shown in figures 5-6 and 5-7. Release sequence for stores on a single rack is also shown in figure 5-4. Release sequence shown for LAU-88/A is for the launcher on Station 3; the LAU-88/A sequences from outboard to inboard. On

45 four chaff/flare dispensers are installed in each main landing gear pod and each wing tip. The dispenser release sequence is illustrated in figure 5-5.

Figure 5-8 covers carriage of like stores. Each configuration is illustrated to show the pylon station on which the store is certified, the approved rack loading, and the carriage, release, and jettison limits pertinent to each store making up the configuration. Unless otherwise noted, all 11 pylons with the basic parent racks are installed on the configurations listed.

WARNING

- Only the configuration shown in figure 5-8 or mixed configurations properly obtained from those shown, may be carried, released, or jettisoned. Unauthorized loads may result in flutter, overstress, cg travel aft of the approved limit during carriage, and unpredictable ordnance separation characteristics during release or jettison.

DEFINITIONS

BASIC AIRCRAFT — An aircraft with 11 pylons, including pylon bomb racks, without stores or suspension equipment (TER's, etc.) up loaded.

SYMMETRIC FLIGHT — Symmetric flight is flight involving no roll or sideslip.

LIKE STORE CONFIGURATION — A configuration that consists of only one store type.

MIXED STORE CONFIGURATION — The simultaneous carriage or loading of two or more unlike store types on a given aircraft. Unlike store types may never be loaded on the same multiple carriage rack.

FERRY CONFIGURATION — The carriage of external tank(s) is a ferry configuration.

EMPLOYMENT — The use of a store for the purpose and in the manner for which it was designed, such as releasing a bomb, launching a missile, firing a gun, or dispensing a submunition.

FLIGHT STRENGTH DIAGRAM

Weight 30,000 Pounds Speed Brakes Closed

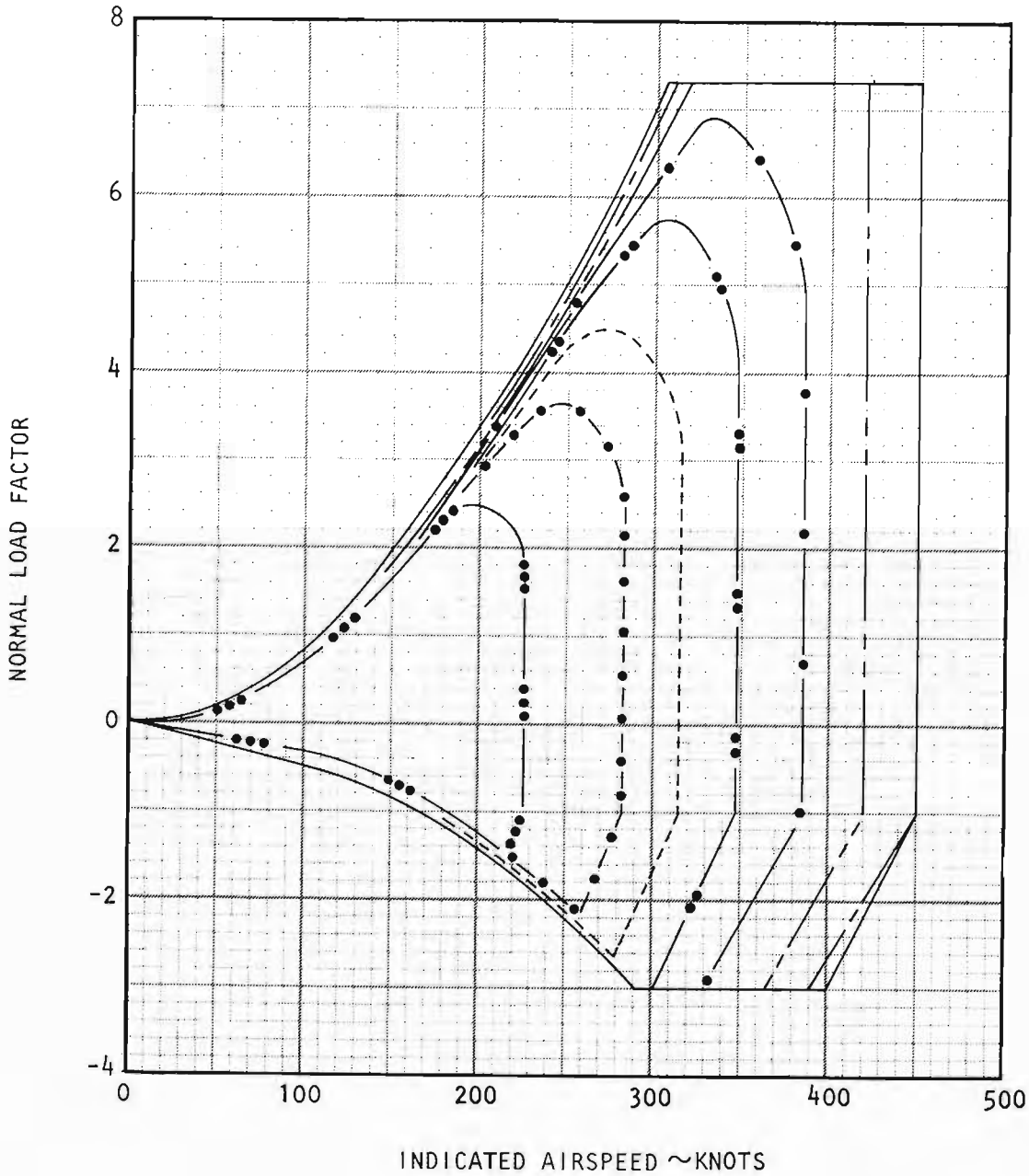
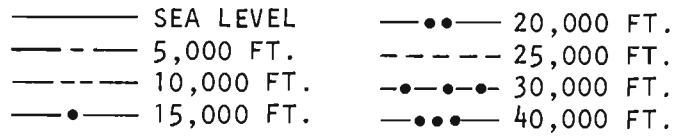

A1-10A-5-10

Figure 5-3. (Sheet 1 of 3)

FLIGHT STRENGTH DIAGRAM

Weight 46,000 Pounds Speed Brakes Closed

- | | |
|--------------------|----------------------|
| ————— SEA LEVEL | —●— 20,000 FT. |
| — - - - 5,000 FT. | - - - - 25,000 FT. |
| — · - - 10,000 FT. | - · - · - 30,000 FT. |
| — ● - - 15,000 FT. | — ●●● - 40,000 FT. |

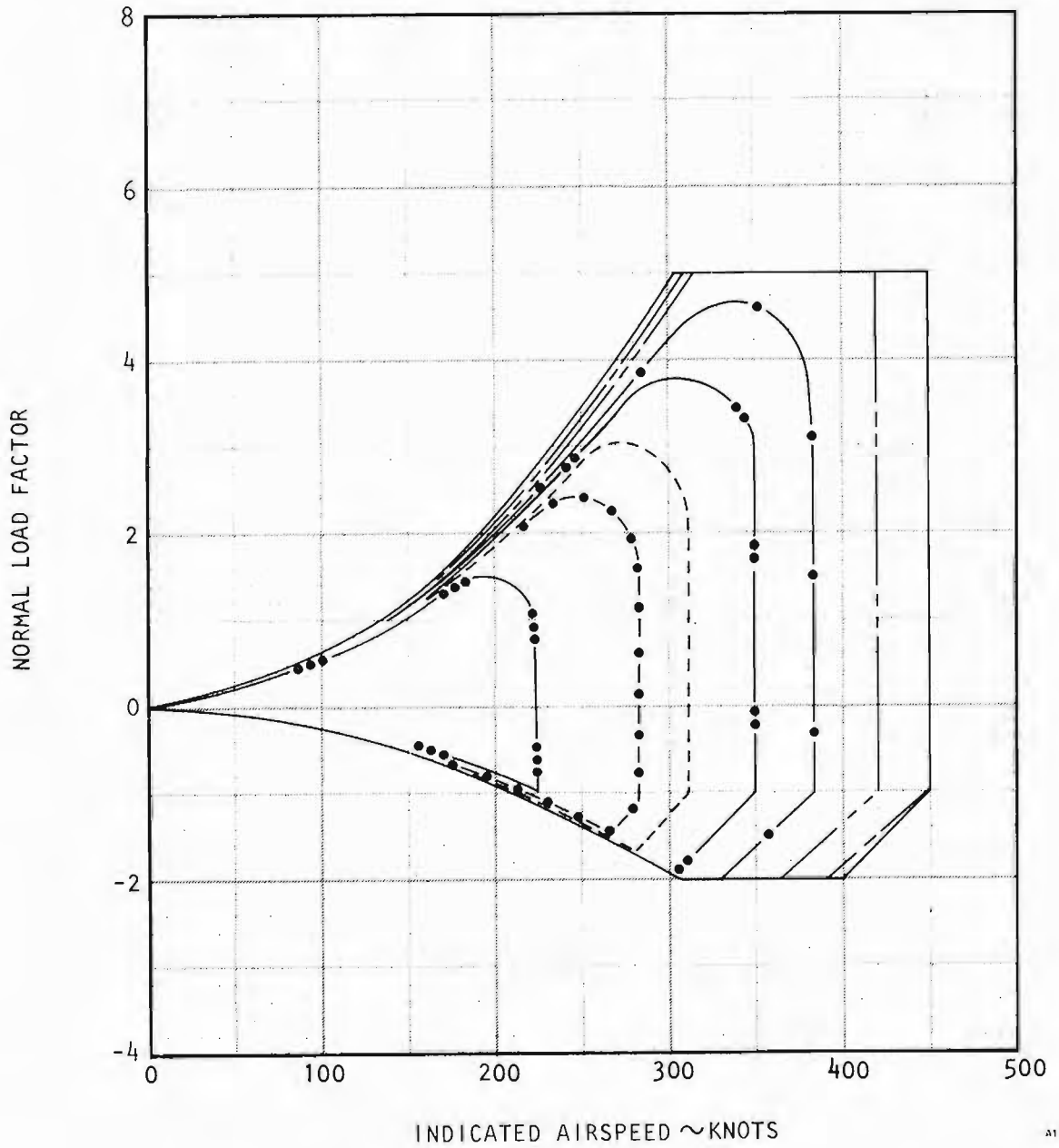

A1-10A-5-11

Figure 5-3. (Sheet 2 of 3)

FLIGHT STRENGTH DIAGRAM

(SUBJECT TO EXTERNAL STORE STRENGTH LIMITATIONS)

- SYMMETRIC FLIGHT - SPEED BRAKES OPEN OR CLOSED
- SYMMETRIC FLIGHT - SPEED BRAKES CLOSED
- SYMMETRIC FLIGHT - SPEED BRAKES OPEN
- ASYMMETRIC FLIGHT - SPEED BRAKES OPEN OR CLOSED

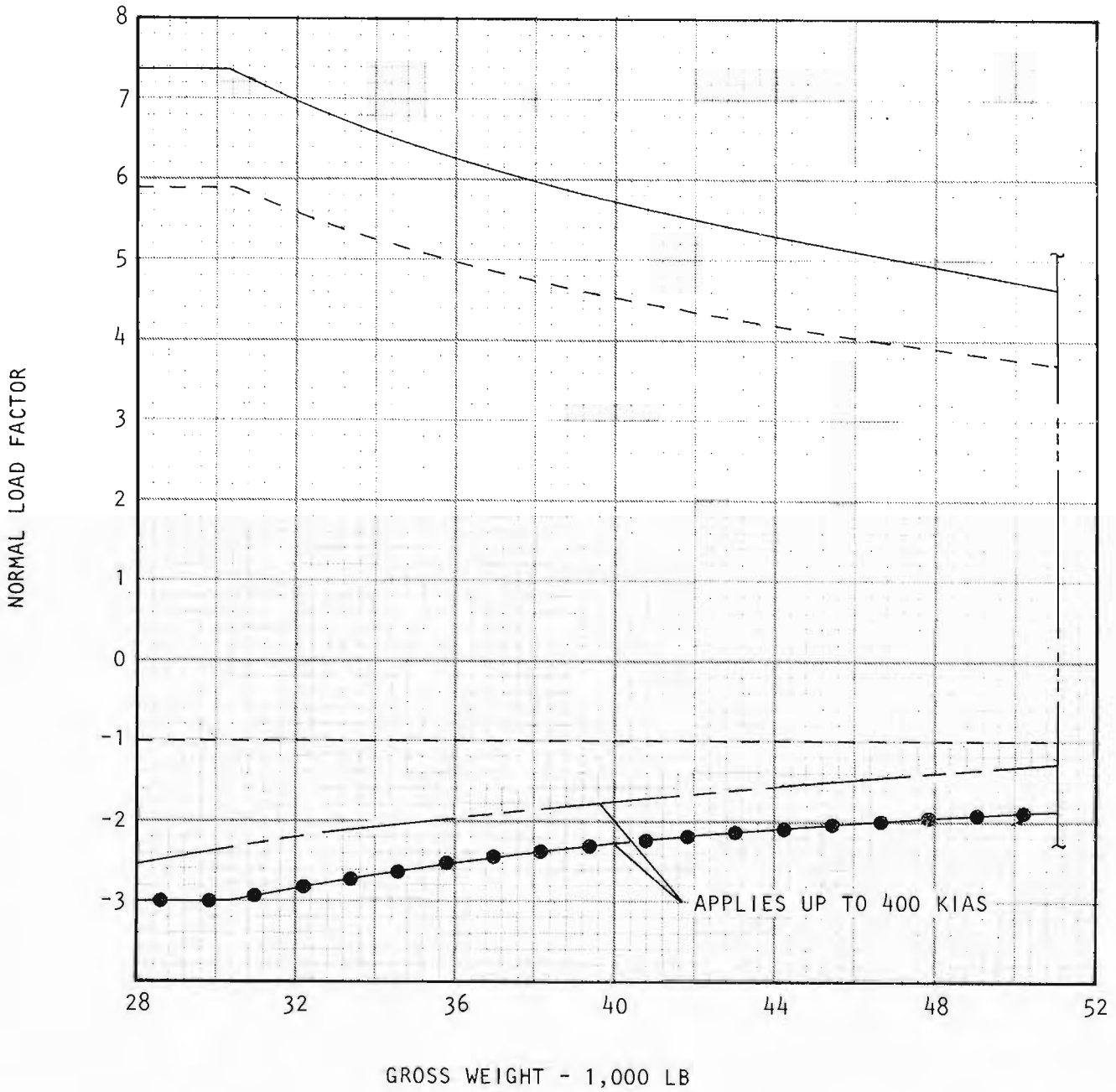

01-10A-5-12

Figure 5-3. (Sheet 3 of 3)

SYMBOLS USED IN STORES LIMITATIONS CHARTS

1. STORES (AS VIEWED FROM BEHIND)			
BLANK		PYLONS OPTIONAL	
P		PYLONS REQUIRED	
C		CLEAN (PYLON REMOVED)	
●		LOADED PYLON	
▽	TER-9		RELEASE SEQUENCE
▽●			LOADED TER
T	LAU-88		LEFT SIDE FIRING SEQUENCE
			RIGHT SIDE FIRING SEQUENCE
	LOADED LAU-88		
●	WEAPON		DRA
	FUEL TANK		LOADED DRA
○	CARGO POD		
■	ECM POD		
2. RELEASE MODE			
S	SINGLE RELEASE	RS	RIPPLE SINGLES
P	PAIR RELEASE	RP	RIPPLE PAIR
A	ALL RELEASE	SJ	SELECTIVE JETTISON

01-10A-5-13

Figure 5-4

CHAFF/FLARE DISPENSING SYSTEM RELEASE SEQUENCE 45

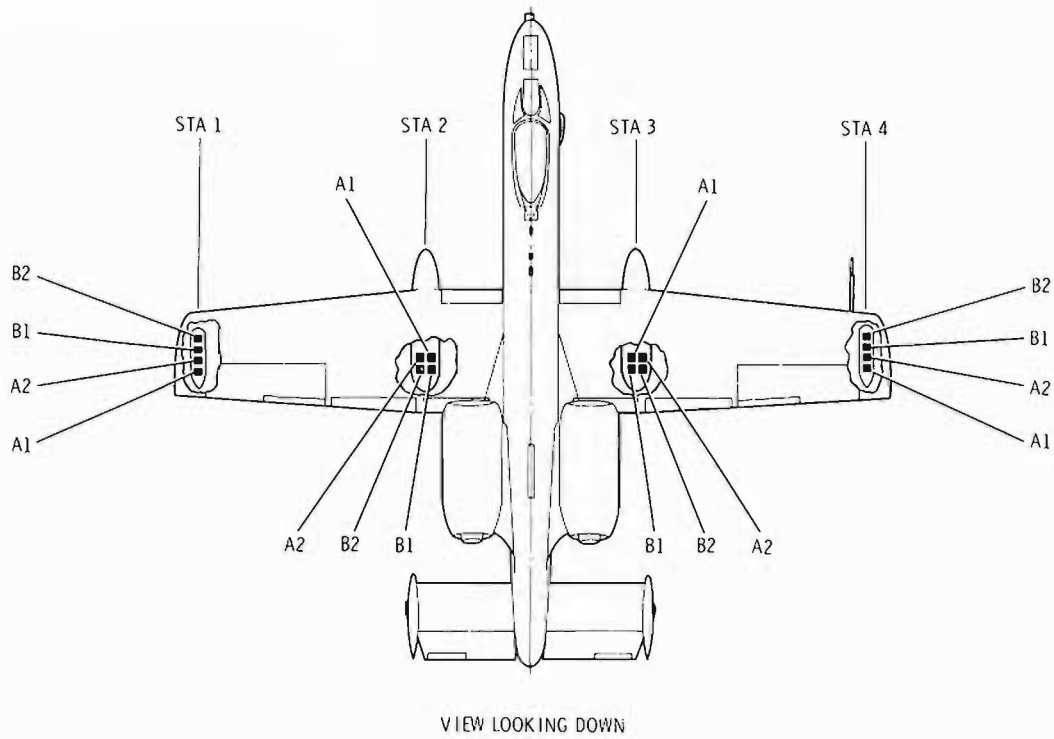

STORES	RELEASE SEQUENCE (STATIONS)
RR-170 A/AL CHAFF CARTRIDGES (SINGLE)	1,4,2,3
RR-170 A/AL CHAFF CARTRIDGES (DOUBLE)	1 AND 4, 2 AND 3
M-206 FLARE CARTRIDGES	3,2,4,1
<p>NOTE</p> <p>EACH STATION WILL RELEASE ITS STORES IN THE ORDER A1, A2, B1, B2.</p>	

Figure 5-5

LIKE STORE PARTIAL CONFIGURATIONS

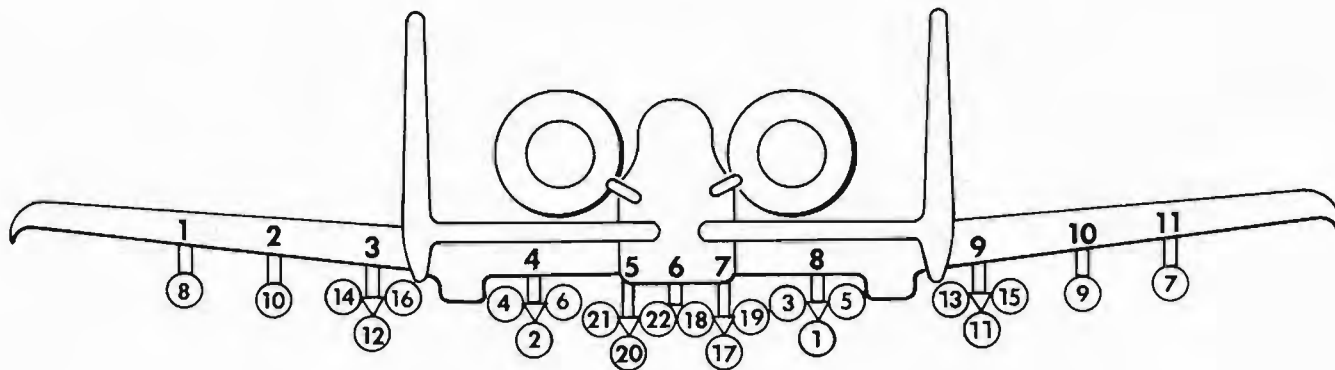

NORMAL STORES RELEASE SEQUENCE WITH TERS

VIEW
LOOKING
FORWARD

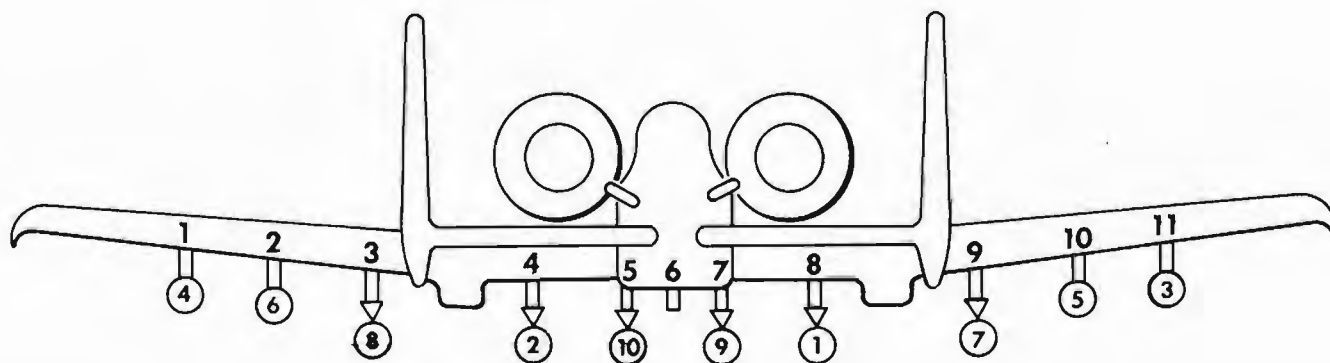

NORMAL STORES RELEASE SEQUENCE

Figure 5-6

MIXED STORE PARTIAL CONFIGURATIONS

(NORMAL RELEASE SEQUENCE)

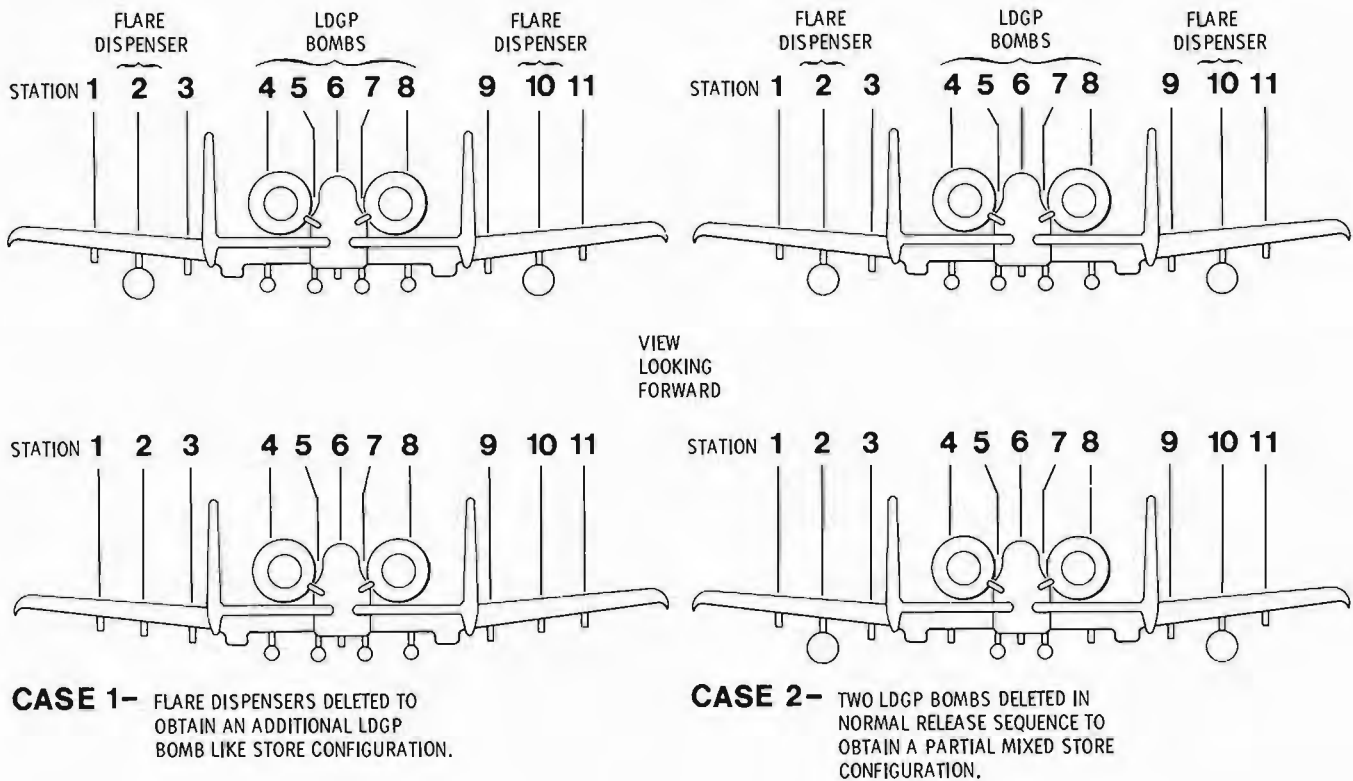

1-10A-5-19

Figure 5-7

RIPPLE — The separation of two or more stores, submunitions, etc., one after the other in a given sequence at a specified interval.

GENERAL RESTRICTIONS AND DEFINITIONS

The following paragraphs present restrictions applying to carriage, employment, release, and jettison of the configurations shown in figure 5-8 and to their mixed configurations. Definitions are included for all the terms used in the columns of figure 5-8.

1. For mixed type store configurations, the carriage, release, and jettison limits are given for each store type. The limits of the most restricted store apply as long as that store is retained.

2. The limits shown represent maximum safe performance limits for the specific aircraft/store combinations depicted. T.O. 1A-10A-34-1-1 presents data to allow computation of optimum delivery envelopes, and as such, occasionally presents numbers that conflict with the limits presented in figure 5-8. In such cases the limits in figure 5-8 are authoritative and override the data presented in T.O. 1A-10A-34-1-1.

Stores Carriage

1. The symbols used in figure 5-8 for the station loading and suspension columns define the specific rack locations for the carriage of the stores. These locations must be adhered to in each particular configuration.
2. Carriage airspeed limits for each configuration are listed in KIAS and TMN. Carriage is restricted to whichever of the two airspeed values is less.
3. Empty LAU-88/117 and TER airspeed and acceleration limits are to the limits of the basic aircraft.
4. Figure 5-3 (sheet 3) presents symmetrical acceleration limits as a function of aircraft gross weight. Asymmetric acceleration limits are 80% of the symmetric limits. Acceleration limits in figure 5-8 cover essentially typical conditions of symmetrical and asymmetrical pullouts, and do not consider gross weight variations. For any set of conditions, both figures should be consulted and the more restrictive load factor limit observed.

STORE CONFIGURATIONS

Mixed and like store configurations are obtained from the existing certified station/store configurations

illustrated in figure 5-8 (sheets 5-12) using the following rules:

1. Pylon stations 3 through 9: Certified stores may be loaded in any combination to obtain mixed or like store configurations on the certified stations.
2. Pylon stations 1, 2, 10, and 11:
 - a. Certified stores may be combined with any station 3 through 9 mixed/like store configurations.
 - b. Mixing of stores on these stations is not authorized; EXCEPTION: NOTE A, General Notes Relating to External Stores Limitations [Figure 5-8 (Sheet 3 of 30)].
3. Pylon stations 1 through 11:
 - a. Mixing of stores on individual TER-9/A loaded stations is not authorized.
 - b. Authorized release sequence is optional/mission determined except from individual TER-9/A and LAU-88 loaded stations, which require normal release sequence.

Employment

Airspeed and acceleration (g's) limits quoted under the Employment column of figure 5-8 are applicable to releasing stores from suspension equipment, TER's or pylon bomb racks, the launching of rockets and missiles, and the dispensing of flares and practice bombs, etc.

1. When carrying stores of mixed types, any one store type may be selected for release in its normal release sequence on any given bomb run. A store may be selectively jettisoned out of the normal release sequence if the pilot determines that it is no longer safe for the aircraft to carry that store, but in general the normal release sequence will be used when selectively jettisoning stores. Rule 2 below applies.

2. All configurations shown in figure 5-8 are assumed to consist of like store types unless otherwise noted in the Station Loading and Suspension Columns. When a general type such as BLU, SUU, etc., is listed, the same assumption applies. Therefore, when various specific versions of a specific store type (i.e., A/B, B/B, C/B) are mixed in a like or mixed store configuration, these specific series should be considered as a single store type in determining authorized release sequence. In other words, if A/B is loaded on Station 2, it must be released in the normal release sequence, prior to a B/B loaded on Station 3.

Minimum Release Interval

To prevent bomb-to-bomb collisions during ripple release of multiple carried stores, minimum release intervals have been established for applicable store configurations. These minimum release intervals are noted in figure 5-8 for the applicable configurations and must be adhered to.

Jettisoning

Airspeeds and acceleration (g's) limits in the selective jettison column are applicable as follows:

Store — Jettison of stores from the pylon rack or from suspension equipment (TER/SUU-20) attached to the pylon bomb rack.

Rack — Jettison of suspension equipment (TER/SUU-20) from the pylon rack (suspension equipment may be loaded with other stores or empty).

WARNING

- Stores should be jettisoned above the maximum fragmentation clearance altitude when possible, even if jettisoned in a safe condition.
- Limitations for emergency jettisoning of stores and/or suspension equipment (with or without stores) are presented in Note C of figure 5-8.

NOTE

- Selective jettison should be accomplished with the landing gear retracted, if possible.

Stick Throw

Stick throw limits provided in figure 5-8 are drawn from and correspond to roll rate and roll acceleration limitations imposed upon the particular store configuration.

Maximum Dive for Employment

The dive angle listed in this column is the maximum dive angle currently certified from flight test results for tactical employment of a particular store or configuration. The maximum dive angle may in some cases be lower than those shown in delivery envelopes or ballistic tables contained in the weapons delivery manual, since these do not take into consideration flight certification results. Maximum dive angles listed opposite dispensers, such as the SUU-20 or SUU-25, are dive angles for employment of the submunition loaded within the dispensers.

Aircraft/Bomb Collision

When making single or ripple bomb releases, care must be taken to avoid pushover at release. Since the normal acceleration is less than 1 g when in a dive, any further reduction by pushover can cause aircraft/bomb collision. Various weapons have minimum g restrictions even for ejected releases.

Refer to the External Stores Limitations, figure 5-8, for release g limitations.

TOTAL DRAG INDEX

The drag index of stores and racks and gross weight of each are presented in figure A1-1 in T.O. 1A-10A-1-1.

INDEX TO EXTERNAL STORES LIMITATION CHARTS

(Like Store Loads)

BOMB TYPE MUNITIONS	CONFIGURATIONS (Sheet)	FLIGHT LIMITATIONS (Sheet)
MK-82 LDGP/MK-82AIR(LD)	5	6
MK-82 Snakeye/MK-82AIR(HD)	5	6
MK-36 Destructor	5	6
MK-84 LDGP	7	8
GBU-10	5	6
GBU-12	5	6
CLUSTER MUNITIONS		
Mk-20	5	6
DISPENSER MUNITIONS		
SUU-30	5	6
SUU-25	7	8
ROCKETS AND ROCKET LAUNCHERS		
LAU-68 2.75-Inch FFAR	9	10
GUIDED MISSILE		
AGM-65 Maverick Missile	7	8
TRAINING MUNITIONS		
SUU-20 Practice Dispenser	7	8
BDU-33 Practice Bomb	9	10
EXTERNAL GUN POD		
SUU-23 Gun Pod	9	10
EXTERNAL FUEL TANKS		
600-Gallon	9	10
MXU-648 CARGO POD	11	12
ECM		
AN/ALQ-119 or -131(V)	11	12
SPECIAL MUNITIONS		
BL-755	11	12

Figure 5-8. (Sheet 1 of 30)

Figure 5-8. (Sheet 2 of 30) Deleted



Change 1

5-21

GENERAL NOTES RELATING TO EXTERNAL STORE LIMITATION CHARTS

- A. An AN/ALQ-119 or -131(V) ECM pod may be substituted for a store on Aircraft Station(s) 1 and/or 11 for any pure load or mixed load configuration displayed in figure 5-8. If no store is portrayed on Aircraft Stations 1 and 11, then one AN/ALQ-119 or -131(V) ECM pod may be added to one or both stations.
- B. Flight limitations are generated for mixed store configurations by using the most restrictive flight limitations of the store types being carried. If the most restrictive store type is released or jettisoned, then the restrictions associated with the next most critical store will be the limits. The limits for the store types are indexed under the pure loads index chart on sheet 1 of figure 5-8. If stores are being carried singly and multiply on the same configuration, the multiple store limitations will always be the most restrictive and shall limit until all the stores being carried multiply are released or jettisoned.
- C. Recommended emergency jettison airspeed is 250 KIAS or less.
- D. Pylons which are not being utilized to carry stores may be removed. Caution should be exercised to ensure that all store configurations are obtained by following the authorized partial configuration rules. Symmetry should be maintained where possible, however, the only restriction is that the total number of pylons outboard of the gear pod on one side of the aircraft must be within one of the total number outboard of the gear pod on the other side of the aircraft.
- E. General nomenclature is used in the STORE TYPE column of the External Stores Limitations Charts. Figure 5-9 lists authorized series of the generic type and when applicable authorizes components or submunitions of a store. Stores not listed are not authorized.
- F. The configurations displayed in this section are authorized for carriage with the pave penny pylon and pave penny pod installed or with the pave penny pod or pave penny pylon removed.
- G. On 45 aircraft, the configurations displayed in this section are authorized for carriage with AN/ALE-40(V) chaff/flare dispensers loaded or unloaded.
- H. The configurations displayed in this section on pylon stations 5 and 7 are authorized on station 6, provided stations 5 and 7 are not loaded.
- I. Minor flap damage can be expected from 2.75 rocket contact discs when fired from LAU-68 launchers mounted on parent pylons.

WARNING

Flight tests indicate that at airspeeds below 240 KIAS, and stores loading equivalent to 18 MK-82s, the aircraft will depart controlled flight with steady state, uncoordinated, rudder inputs short of full rudder deflection. Insure control inputs are smooth and coordinated when operating under these conditions.

Figure 5-8. (Sheet 3 of 30)

SPECIFIC NOTES REFERENCED FROM EXTERNAL STORE LIMITATION CHARTS

1. The NOSE position of the mechanical fuzing selector should be used when employing high drag bombs for this configuration. The minimum ripple interval is 70 milliseconds.
2. The TAIL or N/T position of the mechanical fuzing selector should be used when employing high drag bombs for this configuration. Ripple release will be restricted to 250 milliseconds and above in the ripple pairs mode of release and ripple singles from stations 5, 6, and 7 or any nonpaired wing stations. Ripple release will be restricted to 130 milliseconds and above in the ripple singles mode of release from any paired wing station. The armament control subsystem will automatically inhibit the release after the first bomb or pair of bombs is released if the release intervals are lower than the ones stated above.
3. The download sequence for Maverick missiles on the LAU-88 launcher should be inboard, center, and outboard. Maverick missiles should never be launched from the inboard rail during training missions, and launch from the center rail position should be avoided during training missions. This will minimize paint and rain erosion coating deterioration on the vertical and horizontal stabilizers.
4. The BL-755 contains both electrical and mechanical fuzing provisions; however, the electrical fuzing functions must be deleted before this munition can be carried on USAF aircraft. This leaves the BL-755 with a mechanical fuze only, and it has been determined that a single point failure in this fuze could cause the BL-755 to open prematurely and dispense submunitions. Because of this hazard, the BL-755 is authorized for use on the A-10 during a wartime emergency only.

Figure 5-8. (Sheet 4 of 30)

A-10 EXTERNAL STORES LIMITATIONS (LIKE STORES)

LINE NO.	STORE	RACK	WEAPONS AND SUSPENSION											KIAS MACH	ACCEL "G"		ROLL RATE STICK THROW
			STATION LOADING												SYM	ROLL	
			1	2	3	4	5	6	7	8	9	10	11				
1	MK-82 LDGP or SE/AIR or MK-36 or MK 20 BDU-50	N/A	●	●	●	●	●		●	●	●	●	●	450 0.75	-3.0 to +7.3	-1.0 to +5.8	Full
			●	●	●	●	●		●	●	●	●	●				
2	SUU-30		●	●	●	●	●		●	●	●	●	●	-2.0 to 6.0	-1.0 to 4.8	See Rmks	
					●	●	●		●	●	●						
3	MK-82 LDGP or SE/AIR or MK-36 or MK-20 or SUU-30 BDU-50	TER-9	●	●	●	●	●		●	●	●	●	●	450 0.75	-3.0 to 7.3	-1.0 to 5.8	See Rmks
4	GBU-10/B, A/B, B/B				●	●			●	●							
5	GBU-10 C/B, D/B, E/B				●	●	●		●	●	●			-2.0 to 5.0	-1.0 to 4.0	See Rmks	
6					●	●		●	●	●							
7	GBU-12/B, A/B BDU-50A/B		●		●	●			●	●		●	●	-2.0 to 5.0	-1.0 to 5.0	See Rmks	
8	GBU-12 B/B C/B, D/B or BDU-50A/B		●	●	●	●	●		●	●	●	●	●				
9			●	●	●	●	●		●	●	●	●	●				

Figure 5-8. (Sheet 5 of 30)

A-10 EXTERNAL STORES LIMITATIONS (LIKE STORES)

EMPLOYMENT					JETTISON				REMARKS
KIAS MACH	ACCEL "G" SYM	DEL ANGLE DEG	INTEVL MSEC	REL MODE	STORE		RACK		
					KIAS MACH	ACCEL "G"	KIAS MACH	ACCEL "G"	
420 0.75	0.5 to 3.0 Low Drag 0.8 to 3.0 High Drag	60 Low Drag 35 High Drag	70 Low Drag High Drag Sec Rmks	S P RS RP SJ	420	0.5 to 3.0 Low Drag 0.8 to 3.0 High Drag	N/A	N/A	<ul style="list-style-type: none"> • See Note 2 for High Drag Ripple Release.
							250 0.75	1.0 Level Flight	<ul style="list-style-type: none"> • See Note 2 for High Drag Release. • See MK-82 multiple carriage limits. • Full roll stick throw except as follows: <ol style="list-style-type: none"> 3/4 roll stick throw for SUU-30 dispensers with no speed brake deflection and 1/4 stick throw with speed brakes deflected. 1/2 roll stick throw for MK-82, MK-36, MK-20 when carried on wing stations with speed brakes deflected.
120 0.75	0.5 to 1.5	60	70 min	S P RS RP SJ for GBU-10 or GBU-12	420 0.75	0.5 to 1.5	N/A	N/A	<ul style="list-style-type: none"> • 3/4 roll stick throw for GBU-10/B, A/B, B/B, C/B, D/B, E/B or GBU-12/B, A/B, B/B, C/B and D/B or BDU-50A/B when carried on wing stations and speed brakes not deflected. 1/2 roll stick throw when carried on wing stations and speed brakes are deflected.
390 0.75					390 0.75				
420 0.75					420 0.75				
			120 min for RS 250 min for RP				250 0.75	1.0 Level Flight	

Figure 5-8. (Sheet 6 of 30)

A-10 EXTERNAL STORES LIMITATIONS (LIKE STORES)

LINE NO.	STORE	RACK	WEAPONS											KIAS MACH	CARRIAGE		ROLL RATE STICK THROW		
			STATION LOADING AND SUSPENSION												ACCEL "G"				
			1	2	3	4	5	6	7	8	9	10	11		SYM	ROLL			
1	AGM-65 or TGM-65	LAU-88			●●●								●●●			450 0.75	-2.0 to 5.0	-1.0 to 4.0	See Rmks
2					●●								●●						
3					●●								●●						
4					●								●						
5					●								●						
6					●●								●●						
7		LAU-117			●								●				-3.0 to 7.3	-1.0 to 5.8	
8	MK-81 LDGP				●	●	●		●	●	●					450 0.75	-3.0 to 7.3	-1.0 to 5.8	See Rmks
9	BLU-52				●	●	●	●		●	●	●	●			450 0.75	-3.0 to 7.3	-1.0 to 5.8	Full
10	SUU-25				●	●							●	●		450 0.75	-3.0 to 7.3	-1.0 to 5.8	Full
11		TER-9			●	●●							●●	●			-2.0 to 5.0	-1.0 to 4.0	See Rmks
12	SUU-20 Practice Disp.					●	●		●	●						450 0.75	-2.0 to 5.0	-1.0 to 4.0	Full
13	AIM-9 AIS POD AIM-9 Training	DRA LAU-114 LAU-105	●●											●●		400 0.75	-2.0 to +5.0	0.0 to +3.0	See Rmks

Figure 5-8. (Sheet 7 of 30)

A-10 EXTERNAL STORES LIMITATIONS (LIKE STORES)

EMPLOYMENT					JETTISON				REMARKS
KIAS MACH	ACCEL "G" SYM	DEL ANGLE DEG	INTEVL MSEC	REL MODE	STORE		RACK		
					KIAS MACH	ACCEL "G"	KIAS MACH	ACCEL "G"	
420 0.75	-0.5 to 3.0	60	N/A	S P	420 0.75	-0.5 to 3.0	250 0.75	1.0 Level Flight	<ul style="list-style-type: none"> • Selective jettison of a missile is accomplished by launching an unarmed unguided missile. • Full roll stick throw except: 3/4 roll stick throw when speed brakes are deflected. • See Note 3.
420 0.75	0.5 to 3.0	60	70 min	S P RS RP SJ	420 0.75	0.5 to 3.0	N/A	N/A	<ul style="list-style-type: none"> • 3/4 roll stick throw when MK-84 is carried on a wing station and speed brakes are not deflected. • 1/2 roll stick throw when speed brakes are deflected.
420 0.75	0.5 to 3.0	60	70 min	S P RS RP SJ	420 0.75	0.5 to 3.0	N/A	N/A	
420 0.75	0.9 to 1.1	10	150 min	S P SJ	325 0.75	1.0 Level Flight	N/A	N/A	<ul style="list-style-type: none"> • Full roll stick throw except: 1/2 roll stick throw for multiple carriage of SUU-25 and speed brakes deflected.
					250 0.75		250 0.75	1.0 Level Flight	
420 0.75	0.5 to 3.0	60	150 min	S P RS RP SJ	325 0.75	1.0 Level Flight			<i>Deleted see 15-75</i>
400 0.75	-2.0 to +5.0	Air- craft Limits	N/A	N/A	N/A	N/A	N/A	N/A	<ul style="list-style-type: none"> • 1/2 roll stick throw with or without speed brakes deflected. • Jettison not authorized.

Figure 5-8. (Sheet 8 of 30)

A-10 EXTERNAL STORES LIMITATIONS (LIKE STORES)

LINE NO.	STORE	RACK	WEAPONS AND SUSPENSION											CARRIAGE				
			STATION LOADING											KIAS MACH	ACCEL "G"		ROLL RATE STICK THROW	
			1	2	3	4	5	6	7	8	9	10	11		SYM	ROLL		
1	SUU-23 Gun Pod	N/A					●		●						450 0.75	-3.0 to 7.3	-1.0 to 5.8	Full
2	BDU-33 Practice Bomb	TER-9			●	●	●		●	●	●				450 0.75	-2.0 to 5.0	-1.0 to 4.0	Full
3	LAU-68 Rocket Launcher			●	●	●				●	●	●			450 0.75	-3.0 to 7.3	-1.0 to 5.8	Full
4		TER-9		●	●	●				●	●	●				-2.0 to 5.0	-1.0 to 4.0	
5	LAU-131 Rocket Launcher			●	▽	▽				▽	▽	●			↓ 450 0.75	↓ -3.0 to 7.3	↓ -1.0 to 5.8	↓ FULL
6	600- Gallon Fuel Tank					○		○		○					250 0.52 3 Tanks	-1.9 to 2.5	0.0 to 2.0	See Rmks
															275 0.58 1 or 2 Tanks			

Figure 5-8. (Sheet 9 of 30)

A-10 EXTERNAL STORES LIMITATIONS (LIKE STORES)

EMPLOYMENT					JETTISON				REMARKS
KIAS MACH	ACCEL "G" SYM	DEL ANGLE DEG	INTEVL MSEC	REL MODE	STORE		RACK		
					KIAS MACH	ACCEL "G"	KIAS MACH	ACCEL "G"	
420 0.75	0.5 to 4.0	60 max	N/A	N/A	250 0.75	1.0 Level Flight	N/A	N/A	Gun pods on aircraft stations 5 and 7 may be fired simultaneously. <i>Deleted See 13-75</i>
420 0.75	0.5 to 3.0	60 max	70 min	S P RS RP SJ	420 0.75	0.5 to 3.0	250 0.75	1.0 Level Flight	
420 0.75	0.5 to 4.0	60 max	220 min	S P RS RP SJ	325 0.75	1.0 Level Flight	N/A	N/A	
420 0.75	0.5 to 4.0	60 max	220 min	S P	325 0.75	1.0 Level	N/A	N/A	CAUTION <i>Note Added</i> Certification test recommended prohibiting use of aft fairings until a more secure mechanism can be implemented. <i>See 13-76</i>
N/A	N/A	N/A	N/A	N/A	250 0.52 3 Tanks	1.0 Level Flight	N/A	N/A	<ul style="list-style-type: none"> • 1/4 roll stick throw with or without speed brakes selected. • Maximum KIAS with 600-gallon tanks are: (1)(2)275/(3)250 KIAS sea level to 15,000 feet (1)(2)265/(3)240 KIAS 15,000 to 20,000 feet (1)(2)240/(3)215 KIAS 20,000 to 25,000 feet (1)(2)195/(3)170 KIAS 25,000 to 35,000 feet (1)(2)180/(3)155 KIAS 35,000 to 40,000 feet Aerial refueling is authorized. • Aircraft center of gravity must not move aft of 31% MAC. <div style="border: 1px solid black; padding: 5px; text-align: center;">WARNING</div> <p>The most aft cg condition does not occur with full or empty tanks, but with partially filled external tanks. This condition results in increased sensitivity in pitch control and decrease in lateral directional control at low airspeeds.</p> <ul style="list-style-type: none"> • Do not take off with partially filled external tanks. • Extension of the landing gear will aggravate the aft cg condition. Extreme caution should be used if landing is required with any partially filled external fuel tanks. • Mixed loads of different model external fuel tanks are not authorized.

Figure 5-8. (Sheet 10 of 30)

A-10 EXTERNAL STORES LIMITATIONS (LIKE STORES)

LINE NO.	STORE	RACK	WEAPONS AND SUSPENSION											CARRIAGE			
			STATION LOADING											KIAS MACH	ACCEL "G"		ROLL RATE STICK THROW
			1	2	3	4	5	6	7	8	9	10	11		SYM	ROLL	
1	MXC-648 Cargo Pod				○	○		○		○	○			450 0.75	0.0 to 3.0	0.0 to 2.4	Full
		TER			∅	∅				∅	∅						
2	FCM Pods		■										■	450 0.75	-3.0 to 7.3	-1.0 to 5.8	See Rmks
2A	QRC80-01(V)-3 (LONG)																
3	BL-755 Cluster Weapon		●	●	●	●	●		●	●	●	●	●	450 0.75	-2.4 to 5.8	0.0 to 4.7	See Rmks
4	CBU-89/B		●	●	●	●	●		●	●	●	●	●				
	(SUU-64/B Dispenser)				●	●	●		●	●	●			-3.0 to 7.3	-1.0 to 5.8		
5	CBU-87/B		●	●	●	●	●		●	●	●	●	●	450 0.75	-2.0 to 5.0	-1.0 to 4.0	See Rmks
	(SUU-65/B Dispenser)				●	●	●		●	●	●						

see below ↓

Add 2B (ALQ131)
2C

See 15-74

Figure 5-8. (Sheet 11 of 30)

A-10 EXTERNAL STORES LIMITATIONS (LIKE STORES)

EMPLOYMENT					JETTISON				REMARKS
KIAS MACH	ACCEL "G" SYM	DEL ANGLE DEG	INTEVL MSEC	REL MODE	STORE		RACK		
					KIAS MACH	ACCEL "G"	KIAS MACH	ACCEL "G"	
N/A	N/A	N/A	N/A	N/A	N/A	N/A	N/A	N/A	<ul style="list-style-type: none"> The MXU-648 is not jettisonable. Modified (5G)MXU-648 authorized 0.0 to +5 "G" SYM +4 "G" roll. Deleted 15-75
350 0.75	0.8 to 3.0	15	140 min	S P RS RP SJ	250 0.75	0.5 to 3.0			<ul style="list-style-type: none"> Full roll stick throw except: 3/4 roll stick throw when speed brakes are deflected. ECM pods are not jettisonable.
					420 0.75	0.5 to 3.0			<ul style="list-style-type: none"> Full roll stick throw except: 3/4 roll stick throw when speed brakes are deflected. See Note 4.
420 0.75	0.5 to 3.0	60	70 min						<ul style="list-style-type: none"> Full roll stick throw except: 3/4 roll stick throw when carried on wing stations 1, 2, 10, and 11 and speed brakes are deflected.
									<ul style="list-style-type: none"> Full roll stick throw with or without speed brakes deflected.
									<ul style="list-style-type: none"> 1/4 roll stick throw with speed brakes deflected. 3/4 roll stick throw speed brakes not deflected.
									<ul style="list-style-type: none"> 3/4 roll stick throw with speed brakes deflected. Full roll stick throw without speed brakes deflected.

Figure 5-8. (Sheet 12 of 30)

All data on pages 5-32 through 5-48, including sheets 13 through 29 of figure 5-8, deleted.

Figure 5-8. (Sheet 30 of 30) Deleted.

Change 1

5-49

STORE NOMENCLATURE

<u>Basic Generic Store Types</u>	<u>Authorized Nomenclature Series</u>
AGM-65 Maverick Missile	AGM-65A,B,D, and AA 37A-T1 Training Guided Missile (TGM-65)
AIM-9 Sidewinder Missile	AIM-9 Series, All AIM-9 Training Missiles
AIS Pod	ALL
ALE-40 Dispenser	RR-170 A/AL Chaff Cartridges and M-206 Flare Cartridges
BLU-52	BLU-52/B, A/B
ECM Pods	AN/ALQ-131 (Terminal Threat Version), AN/ALQ-119(V) -10, -12, -15, -17, QRC-80-01/V3, V4
GBU-10	GBU-10/B, A/B, B/B, C/B, D/B, E/B
GBU-12	GBU-12/B, A/B, B/B, C/B, D/B (BDU-50A/B, W/LGB Kits)
LAU-68 Rocket Launcher	LAU-68A/A, B/A, with 2.75 FFAR w/MK-4 or MK-40 Motors and MK-1, MK-5, M151, M156, WDU-4A/A or WDU-13/A Warheads or MK-61, WTU-1/B Practice Warheads
LAU-131 Rocket Launcher	LAU-131/A with FFAR w/MK40 and MK66 Motors and MK1(HE), MK5(HEAT), MK151(PMI), MK156(WP), WDU-4A/A and -13A(FLECHETTE), MK61(TP), WTLL-1/B(TP), and MK67(RED PHOSPHOROUS) WARHEADS.
MK-20 Cluster	MK-20 MOD 3, MOD 4
MK-36 Destructor	MK-36 MOD 1, MOD 2, MOD 3
MK-82 LDGP	None
MK-82 SNAKEYE (SE)	None
MK-82 AIR (BSU-49/B)	None
MK-84 LDGP	None
Pod, Cargo	MXU-648/A; (5G) MXU-648/A
Practice Bomb Series	BDU-33A/B, B/B, D/B (BDU-33/B is compatible only w/ SUU-20) BDU-50/B; A/B; MK82 Series.

*Changed
see 15-174*

Figure 5-9 (Sheet 1 of 2)

STORE NOMENCLATURE (CONT)

<u>Basic Generic Store Types</u>	<u>Authorized Nomenclature Series</u>
SUU-20 Dispenser	SUU-20/A, A/M, A/A, B/A with BDU-33/B, A/B, B/B Practice Bombs; 2.75 FFAR w/MK-4 or MK-40 Motors and MK-1, MK-5, M151, M156, WDU-4A/A or WDU-13/A Warheads or MK-61, WTU-1/B Practice Warheads
SUU-23 Gun Pod	SUU-23/A Deleted See 15-75
SUU-25 Dispenser	SUU-25 C/A, SUU-25E/A, with MK-24 MOD 4, LUU-2/B, LUU-2A/B, LUU-2B/B, LUU-2C/B, and MJU-3A/B Flares; LUU-1/B, LUU-5/B, and LUU-6/B Target Markers
SUU-30 Dispenser	CBU-24B/B, -49B/B, 52B/B, 58/B, -58A/B, -71/B, -71A/B Cluster Bomb.
SUU-64/B Tactical Munitions Dispenser	CBU-89/B Cluster Bomb (CEM)
SUU-65/B Tactical Munitions Dispenser	CBU-87/B Cluster Bomb (Gator)
Tank, Fuel	600-Gallon (Royal Industries PN 754-0868-10 or Sargent Fletcher PN 32-600-48270)

Figure 5-9 (Sheet 2 of 2)

SECTION VI

FLIGHT CHARACTERISTICS

TABLE OF CONTENTS

General Flight Characteristics	6-1	Manual Reversion Spin Recovery	6-10
Flight Control Effectiveness	6-1	Single-Engine Flight Characteristics	6-10
Level Flight Characteristics	6-2A	Manual Reversion Single-Engine	
Maneuvering Flight Characteristics	6-3	Flight Characteristics	6-11
Adverse Yaw	6-4	Engine Operation	6-12
Dives/Compressibility Effects	6-4	Failure Mode Flight Characteristics	6-12
Manual Reversion Flight		Loss of One Pitch Mechanical	
Characteristics	6-5	Command Path	6-12
Stalls	6-6	Single Operable Elevator	6-12
Out-of-Control Characteristics	6-7	Single Operable Aileron	6-12
Departures	6-7	Loss of Mechanical Command	
Post-Stall Gyration	6-9	Paths to Rudders	6-13
Sideslip Departures	6-9	Loss of All Mechanical Command	
Spins	6-9	Paths and Hydraulics On	
Stall/Departure/Spin Avoidance	6-9	One Side	6-13
Out-of-Control Recovery		Runaway Trim	6-13
Characteristics	6-10	Flap Asymmetry	6-13

GENERAL FLIGHT CHARACTERISTICS

Satisfactory levels of stability and control exist throughout the airspeed and altitude flight envelope of the A-10A. Stability is further improved by the use of a SAS in the pitch and yaw axes.

FLIGHT CONTROL EFFECTIVENESS

Either hydraulic system is capable of providing sufficient power for control at any speed or altitude within the flight envelope with one or both engines running.

Roll Control

The ailerons provide satisfactory roll control throughout the flight envelope. Roll response increases with increasing speed brake setting up to approximately 20%, is relatively flat between 20% and 40%, then begins to fall off again until roll response at 80% again equals response at 0% deflection. Roll rates up to 130° per second can be expected with 0% speed brakes at 300 KIAS, and up to 200° per second with 40% speed brakes at 300 KIAS. Roll control and forces are the same with one or both hydraulic systems operating. On [83] a full-time ARI provides turn coordination as long as the yaw SAS is engaged. On [84] a Beta Dot (sideslip rate) SAS performs this function.

Pitch Control

The aircraft is free of any unusual pitch change tendencies and has effective pitch control throughout the flight envelope. Pitch control and forces are the same with one or both hydraulic systems operating.

The A-10 is resistant to PIO (SAS-ON) throughout the flight envelope. With three fuel tanks (SAS-OFF) and aft cg, the A-10 has a definite susceptibility to PIO at higher Mach numbers. The most positive method to stop PIO is to release the stick if flight conditions permit. If flight conditions do not permit releasing the stick, then holding the stick aft of center will stop the PIO.

Yaw Control

The rudder becomes effective at approximately 50 KIAS. Rudder inputs produce yaw with little rolling motion. A yaw SAS provides yaw damping, rudder trim, and turn coordination. Rudder authority is 25° below 240 KIAS but is reduced to 8° by a Q-switch above 240 KIAS. Although the A-10 is not a center-line thrust aircraft, the relatively close proximity of the engines to the centerline of the aircraft allows adequate directional control under asymmetric thrust conditions by use of moderate rudder deflection.

On [83] a full-time ARI provides turn coordination. The ARI authority is cut in half at speeds above 255 KIAS. On [84] the Beta Dot SAS reduces sideslip rate through automatic application of rudder. With a hydraulic supply failure or engine-out condition, the corresponding rudder will revert to manual control. This causes higher rudder forces, but will not reduce the authority of the powered side. The manual powered rudder will trail the powered rudder by as much as 10°. Total rudder available is still sufficient to maintain straight, steady heading flight down to stall speed while operating on a single engine (assuming symmetric loading).

On aircraft equipped with Beta Dot SAS, rudder transients will occur when the attitude indicator passes through $\pm 90^\circ$ pitch attitude. These transients are due to the roll attitude flipping 180° on the ADI in the vertical positions. The HARS, or INS [62] passes this 180° roll input to the SAS. Rudder transients will also occur when the HARS, or INS supplies a bank angle to the SAS (as indicated by a bank on the ADI) and the SAS gains are changed when passing through 180 or 255 KIAS. Transients

will also occur any time the ADI is indicating a bank angle and a HARS, or INS failure occurs resulting in a zero bank angle input to the SAS. This also occurs when switching from DG to slaved mode, or when the sync button is depressed while operating in HARS. This is indicated by the appearance of both HSI and ADI off flags. When the fast erect button is depressed the HARS supplies a zero bank angle signal to the SAS and will cause rudder transients if the ADI is indicating a bank. Any time a double failure of HARS and INS occurs, the yaw SAS will be disconnected. Yaw SAS may be reengaged by switching into override and reengaging the yaw SAS switches. Mild transients will occur if in a steep bank.

WARNING

- When the ADI is indicating a bank, certain HARS, or INS failure modes may cause the Beta Dot SAS to give a full SAS authority rudder input. If any HARS malfunctions occur or are suspected, establish a wings level attitude and disengage yaw SAS [61]. On [62], any INS malfunction causing loss of attitude validity will automatically transfer attitude and heading inputs to HARS. In the event of a failure where transfer does not occur or a failure of the HARS affecting roll servo validity, the HARS/SAS validity assembly [64] will automatically disengage yaw SAS, possibly producing a rudder response. A HARS or INS induced rudder hardover during constant altitude, steep bank maneuvers is normally recovered in less than 50 feet. In a descending steep bank, additional altitude will be required. After a wings level attitude has been established, yaw SAS may be reengaged, using the HARS/SAS override switch [64] for yaw damping and trim; however, turn coordination will not be provided.

Flaps

The flaps increase lift, which decreases aircraft stall speed and increases g available at low speeds. Extension of the flaps results in a slight nose down pitch change. The 7° flap position is used for takeoff since it increases lift on the wing but does not introduce a great deal of drag or nose down pitch moment. The

20° flap position is used for landing since it greatly increases lift and drag, which allows slower landing speeds and higher power settings. Takeoff ground runs with flaps at 20° are longer than those with flaps at 7°.

Speed Brakes

The speed brakes are very effective at creating high drag. They are limited to 80% deflection in flight but can extend 100% with weight on the main gear. Speed brake deflection will increase the aircraft pitch attitude at a given speed requiring a nose down trim correction. This trim correction is automatically applied when the pitch SAS is engaged.

LEVEL FLIGHT CHARACTERISTICS

The A-10 possesses good low speed stability characteristics and handling qualities, especially at low altitudes. However, neutral or even negative stability will be encountered at high speed and at high altitude. Hence, the A-10 is difficult to trim and keep trimmed. Three external fuel tanks decrease stability, especially at higher speeds and aft cg's.

NOTE

- Air refueling with three external fuel tanks, SAS ON, requires no more than normal pilot workload under most conditions. With SAS OFF, the pilot workload for successful refueling is increased.

Reflects TO 1A-10A-1SS-73 dated 30 September 1988.

TO 1A-10A-1

MANEUVERING FLIGHT CHARACTERISTICS

The A-10A is highly maneuverable with excellent instantaneous g available and relatively high roll rate capability throughout its flight envelope. Stick force and stick position per g for a given airspeed are essentially linear throughout the flight envelope. Increasing force and aft stick are required for increased g.

WARNING

- Aircraft stability is decreased at altitudes above 15,000 feet.

NOTE

- The carriage of external fuel tanks, full or empty, decreases directional stability. Rolling maneuvers in this configuration may cause large sideslip angles, particularly without the yaw SAS engaged, and are not recommended. During landing, a straight-in approach or a wide, conservative traffic pattern is recommended so that large sideslip angles can be avoided.
- On Beta Dot SAS equipped aircraft [84], rudder vibration may be experienced during maneuvering at high angles of attack. Sustained vibration should be avoided. If rudder vibration is experienced, relaxation of the g load or disengagement of the SAS will terminate the vibration.

While instantaneous capability is excellent, the relatively low thrust to weight ratio of the aircraft adversely affects sustained turn performance. Charts provided in TO 1A-10A-1-1 (figures A6-7 and A6-8) can be used to determine sustained and instantaneous g available. The limited sustainable g of the aircraft dictates that extreme caution be exercised when sustained high AOA and high bank angle maneuvering is conducted at low altitude. Low altitude flight at bank angles in excess of 90° (inverted or semi-inverted) demands caution due to high turn rate and instantaneous g capability. At normal operational speeds, turn rates in excess of 15° per second can be generated with as little as

four radial g's on the aircraft. With the lift vector pointed down, this results in a rapidly developing negative flight path angle. The rate at which this occurs allows little time for pilot inattention to aircraft attitude.

The hazards associated with high bank, high AOA, and high g flight at low altitude are compounded by the lack of visual cues available. The canopy/cockpit design allows subtle flight path and attitude changes to go unnoticed by the pilot when he is not monitoring attitude and flight path in conjunction with a horizon reference. During low altitude maneuvering, the pilot must maintain situational awareness and ensure the energy state and attitude of the aircraft are not allowed to deteriorate to a condition where recovery is impossible. The aural peak performance/stall warning system of the aircraft can be used effectively to enhance maneuvering performance and to avoid wing stall. Insufficient lateral visual cues are available during low altitude maneuvering flight if the pilots attention is not focused on monitoring aircraft attitude and flight path. This may lead to conditions from which recovery is impossible.

Maximum instantaneous g available occurs just prior to wing stall. To obtain maximum maneuvering performance while retaining some margin for error, the aircraft should be flown in the steady tone regime.

The peak performance/stall warning system is not compensated for rapid AOA rates. Rapid stick motion can produce AOA overshoots into the region where wing stall and engine disturbance can occur. To avoid these conditions, the pilot should be alert to the approach of the steady, peak performance tone and reduce the pitch rate accordingly. At high pitch rates, the steady and chopped tones will appear to occur simultaneously. At that point, it is necessary to immediately check the maneuver and adjust the g loading accordingly. Maneuver checking may require forward stick movement equal and opposite to that used to produce the initial pitch rate.

WARNING

- Engine(s) disturbances during high pitch rate maneuvering may result in engine(s) overtemp or engine(s) stall/stagnation. This may require engine(s) shutdown and restart.

Reflects TO 1A-10A-1SS-73 dated 30 September 1988.

CAUTION

- At high pitch rates, AOA overshoots and consequent engine disturbances can occur despite checking the maneuver at the steady tone. To avoid AOA overshoots at high pitch rates, the pilot must anticipate the approach of the steady tone.
- The cockpit AOA indicator may lag true aircraft AOA by as much as eight units during a high rate maneuver. Caution must be exercised during rapid maneuvering at high AOA to avoid inadvertently exceeding the aircraft AOA where engine disturbances may occur (figure 6-2).

NOTE

- Aircraft load factor limits must be observed during maneuvers when using the aural tones as aides since it is possible to overstress the aircraft while maneuvering at peak performance in certain flight regimes.

Reflects TO 1A-10A-1SS-73 dated 30 September 1988.

CAUTION

- Do not sustain full rudder inputs when rolling the aircraft at high AOA.

NOTE

- Proverse yaw does not tend to produce noticeable sensations of uncoordinated flight as does adverse yaw.

ADVERSE YAW

The A-10 produces adverse yaw during rolling maneuvers. Adverse yaw is the tendency for the nose of the aircraft to move in the opposite direction of roll. The amount of adverse yaw produced increases as roll rate, AOA, or g level increases. An ARI incorporated into the SAS system reduces the adverse yaw effect during rolling maneuvers [83]. When the ailerons are deflected, the rudder is automatically deflected in the direction of roll to help reduce the adverse yaw. For relatively small aileron inputs, the ARI keeps the yaw very small. A Beta Dot (sideslip rate) damping system reduces sideslip for low to moderate roll rates [84]. With either SAS, additional rudder is required to coordinate turns. For large rapid roll inputs above the rudder Q-limit speed (240 KIAS), there will not be enough rudder available to completely coordinate high rate rolls since rudder is limited to 8°. This is especially evident under high g conditions. When performing rapid roll reversals, the aircraft can experience large sideslip angles when the AOA is also high. This greatly increases the likelihood of wing stall and engine disturbances, particularly when the pilot attempts to maintain or increase the load factor throughout the roll reversal. The pilot can greatly minimize the likelihood of stall and engine disturbance by decreasing the back stick pressure during the roll. Yaw can be reduced and roll rate increased by leading high g rolling turns with rudder. However, once a significant roll rate is established, rudder should be reduced to coordinate the turn. Full rudder should not be sustained in combined pitch and roll maneuvers while at high AOA (above the peak performance tone level). This will avoid large proverse sideslip angles (nose inside the turning flight path) of magnitudes comparable to the adverse yaw angles in uncoordinated rolling turns. Either adverse yaw or proverse yaw sideslip, while stalled, will place the aircraft in the engine disturbance area (figure 6-2).

Adverse yaw is much more apparent when the yaw SAS is disengaged and turn coordination must be supplied totally by the pilot. Fuel tanks or other destabilizing store configurations also increase adverse yaw.

DIVES/COMPRESSIBILITY EFFECTS

The A-10 displays good lateral/directional control characteristics throughout all dive conditions. As the aircraft approaches limiting Mach, the aircraft tends to "tuck under" or increase its nose down pitch attitude. This is easy to control with light aft stick pressure and aft trim. As the aircraft approaches redline airspeeds (0.75M/450 KCAS), compressibility effects cause shock waves to form on the wing. This condition does not result in any adverse changes in the flight characteristics of the A-10.

The shock waves increase drag and cause increased flow separation along the trailing edge of the wing. This separated flow buffets the trailing edge of the wing causing a slight aileron vibration. This condition may be encountered within 25 knots of the redline. It is more noticeable in bunting (below 1g) maneuvers and reduces as the g is increased. The effects are a mild vibratory buffet of the airframe and shaking of the pitot boom. The tabs and/or ailerons may be observed to vibrate slightly as they respond to the buffeting airflow. The handling characteristics of the aircraft are not affected, and the slight vibratory response is not of concern structurally. The buffet onset is an indication of approach to redline airspeeds and should be used accordingly by the pilot.

As Mach increases above 0.6 the g available decreases somewhat. Wing stall and buffet onset will occur simultaneously and at a lower AOA than at low Mach. Engine disturbance (without sideslip) will occur shortly after wing stall and buffet onset.

Reflects TO 1A-10A-1SS-73 dated 30 September 1988.

MANUAL REVERSION FLIGHT CHARACTERISTICS

Flight tests have demonstrated that the aircraft is capable of moderate maneuvering, recovery, and landing by use of the MRFCS. The aircraft has been flown in the manual reversion mode to dive angles of 90°, airspeeds up to 390 KIAS, to stall, and in spins. Dive recoveries of up to 4 g's have been accomplished.

The roll response is fair and stick forces are moderate to high when operating in the manual reversion mode. Reducing airspeed will reduce the lateral stick forces required for roll response.

Pitch stick forces are high requiring the pilot to frequently trim out the forces. Pitch trimming while in the manual reversion mode is best accomplished by holding in the stick force for the desired trim change and then trimming out the force by utilizing the trim button. If the stick is trimmed without holding in the correction (i.e., flying the aircraft by trim), the resultant trim rate will be quite rapid with the possibility of trim overshoots.

WARNING

- Failure to use pitch trim with caution while in manual reversion, particularly during maneuvering/high airspeed dives, can result in loss of control due to excessive pitch stick forces.

Power effects are very noticeable in manual reversion and are characterized by a nose-up pitch moment when power is applied, and a nose-down pitch moment when power is reduced. Therefore, slow, smooth power adjustments are recommended.

WARNING

- The cumulative effects of failure to use pitch trim, rapid throttle movements, and high speed maneuvering/dives, when in manual reversion, could require stick forces beyond a pilot's physical capability to recover the aircraft.

Transition into manual reversion has been successfully accomplished at forward, mid, and aft cg conditions and at varying airspeeds from 140 - 390 KIAS.

The transition into manual reversion may be accompanied by pitch transients. The magnitude and direction of these transients are primarily dependent upon the elevator tab setting, the cg position, airspeed, and power setting. With flaps extended 20°, a large nose-down pitch moment will occur during and after transition to MRFCS. Full aft stick trim and maximum power may not hold level flight under these conditions.

WARNING

- With flaps full down, maintaining level flight following transition to manual reversion may require aft stick forces which exceed the pilot's physical capability. If transition to MRFCS occurs with flaps full down, it is imperative that the flap emergency retract switch be activated immediately.

With the aircraft in a mid cg configuration, the transition into manual reversion (within the range of airspeeds from 150 - 200 KIAS, power for level flight) is characterized by a small nose-up excursion. If the transition is performed above this airspeed, the magnitude of the transient will increase reaching an approximate 2.7 g nose-up transient at 300 KIAS. Transitions performed with the aircraft in a forward cg configuration will minimize the magnitude of the pitch excursion, while transitions accomplished with the aircraft in an aft cg configuration will tend to increase the excursion. Engine power setting during the transition will also affect the magnitude and direction of the pitch excursion. With throttles at IDLE, the nose-up pitch tendency will be reduced. At some cg conditions (forward cg) and speeds, the power reduction will actually produce a nose-down excursion during the transition. The incremental g experienced during the transition is not additive to the maneuvering load factors. If, for example, a 4 g recovery from a dive is being performed while simultaneously reverting to manual reversion, and aircraft cg configuration and speed are such that they would produce a 4 g transient (incremental 3 g) during the transition, no pitch transient would be experienced. The magnitude of pitch excursions can be reduced significantly by pilot correction.

Most A-10 aircraft tend to roll off to some extent in manual reversion. This is due to manufacturing tolerances, and the fact that there is no lateral trim

in manual reversion. The direction and magnitude of rolloff vary from aircraft to aircraft. This rolloff characteristic is speed-dependent and tends to increase as airspeed increases. Stick forces to maintain level flight can be as high as 25 pounds at 300 KIAS. For long duration flights, the pilot should reduce airspeed and/or use asymmetric thrust to keep wings level and reduce lateral control forces in order to reduce pilot workload and fatigue.

STALLS

The A-10 has little natural (aerodynamic) stall warning, regardless of flap position. Unaccelerated and accelerated stalls below Mach 0.6 are characterized by a slight g-break and post stall buffet. In accelerated stalls above Mach 0.6, buffet occurs with no g-break and masks the actual stall. The airframe buffet with large (60% or greater) speed brake deflections totally masks the stall indications. See figure 6-1 for stall speeds.

Stalls with the gear down have a pronounced nose right yawing tendency due to the location of the nose gear door. The indications of stall with large speed brake deflections are full aft stick, a high rate of descent, or a wing rolloff. Although rollofs are usually mild, they are more abrupt with flaps down. Power setting or SAS do not significantly affect stall characteristics.

Aileron and rudder control can be maintained throughout the stall, provided there is not a large amount of sideslip. Aileron is more effective than rudder in controlling roll. Control effectiveness decreases steadily as AOA increases above stall, and aileron effectiveness also decreases as sideslip increases. In some cases aileron effectiveness can be reduced to near zero when the aircraft is stalled with sideslip present. Yaw can easily be controlled with rudder. In all cases, drag increases dramatically as AOA increases above stall.

CAUTION

- Maintain AOA below stall warning or buffet. If AOA is increased above buffet or stall warning, engine disturbances are likely to occur, particularly at high Mach numbers.

Artificial Stall Warning

Artificial stall warning is provided by a stick shaker operated off the AOA probe, when the gear is down and/or the flap lever is in DN. The stick shaker is activated at 1 – 2 units AOA below the stall AOA. It provides mild agitation of the control stick 4 – 12 knots prior to wing stall (1 g condition).

When the gear is up and the flap lever is in other than DN, the stick shaker is disconnected and a two-tone aural peak performance/stall warning system is activated. The peak performance/stall warning system generates audible signals which allow maneuvering at high performance, and also alert the pilot that the aircraft is approaching the stall. The aural peak performance signal is a continuous tone and the aural stall warning signal is a chopped tone.

The steady peak performance tone occurs approximately two AOA units before the stall. The chopped stall warning tone is activated approximately one AOA unit prior to the stall. The margin between the onset of stall warning tone and wing stall varies with Mach number and AOA as shown in figure 6-2. The chopped stall warning tone does not change in volume or frequency as AOA increases. Thus, actual wing stall or depth of stall indications are not provided by this system.

On 102, aural tone stall warning system is also available with gear down and/or flaps MVR/DN. During accelerated stalls, aural tones occur 6 – 10 KIAS prior to stall regardless of aircraft configuration and gross weight. The steady tone typically comes on 8 – 10 KIAS ahead of stall with chopped tone occurring 6 – 8 KIAS ahead of stall.

Single-Engine Stalls

Single-engine stall characteristics are generally the same as dual-engine stall characteristics except rudder is required to counter asymmetric thrust. However, if a stall is not immediately recovered, a rolloff is produced into the dead engine. This is caused by the operative engine drawing air over the wing and increasing the lift relative to the other wing.

Stalls with Asymmetric Stores

Stalls with the equivalent of 3 AGM-65s and an ALQ-119 on the same wing have been tested. Over 50% of aileron authority is required to avoid a roll-off during unaccelerated stalls. If AOA is increased, full aileron may not control the rolloff. The increased aircraft response to aileron and rudder inputs at higher speeds reduces the control inputs required to avoid rolloff during accelerated stalls.

Stall Recovery

Reducing AOA to below stall warning by relaxing aft stick pressure will produce an immediate recovery. Retracting speed brakes and applying maximum power will decrease altitude loss; which for idle, unaccelerated stalls is largely dependent upon engine acceleration time. Altitude loss during an unaccelerated landing configuration stall recovery is less than 1,000 feet. During recovery to level flight, the lack of natural stall warning may result in secondary stalls unless the stick shaker, AOA indexer, AOA indicator, or aural tones (depending on configuration) are used as references. Accelerated stall recoveries are immediate with relaxation of aft stick pressure.

OUT-OF-CONTROL CHARACTERISTICS

DEPARTURES

The A-10A aircraft possesses excellent flying qualities for the designed mission. Adequate stall warning and departure avoidance are essential in this environment and have been the subject of test and emphasis since

the initial flights of the aircraft. With the exception of inadequate natural stall warning, which was somewhat resolved by using a dual stall warning tone system, the A-10A has excellent stall/post-stall/spin characteristics. Directional and pitch stability is positive for all angles of attack. The aircraft is resistant to departure and requires sideslip angles in excess of 20° to precipitate an out-of-control condition or post-stall gyration (PSG). The aircraft can be flown into the PSG condition however, with large sideslip angles or if large roll rates are demanded when the angle of attack (AOA) is high. The natural resistance of the aircraft to enter this out-of-control regime decreases as altitude increases and/or if the yaw damper system is off or malfunctioning. The altitude effect is caused by the less effective vertical fin with normal indicated airspeeds at the higher altitudes as well as the increased propensity for higher AOA's at the higher altitudes. At higher altitudes (15,000 feet and above) aircraft maneuvering is normally accomplished at lower indicated airspeeds and higher AOA's but with the capability to still generate high yaw and roll rates. These are the ingredients for yaw-roll coupling. Yaw-roll coupling is a rapid exchange of AOA for sideslip. AOA's of more than 20° are easily generated at the higher altitudes, and if this AOA is then converted (through a rapid roll) to sideslip, a departure will result. The flying technique to prevent this sideslip during maneuvers is simply to release back stick (reduce g or AOA) prior to large roll inputs. The roll response using this technique is better and a crisp, concise maneuver results. The g can be immediately reapplied after the roll is completed.

If the aircraft enters the out-of-control arena either through this yaw-roll coupling, excessive sideslip, or from a classic cross control situation, two distinct post-stall gyrations may result. These are characterized by either a roll reversal or a roll acceleration.

STALL WARNING AND ENGINE/AIRFRAME COMPATIBILITY

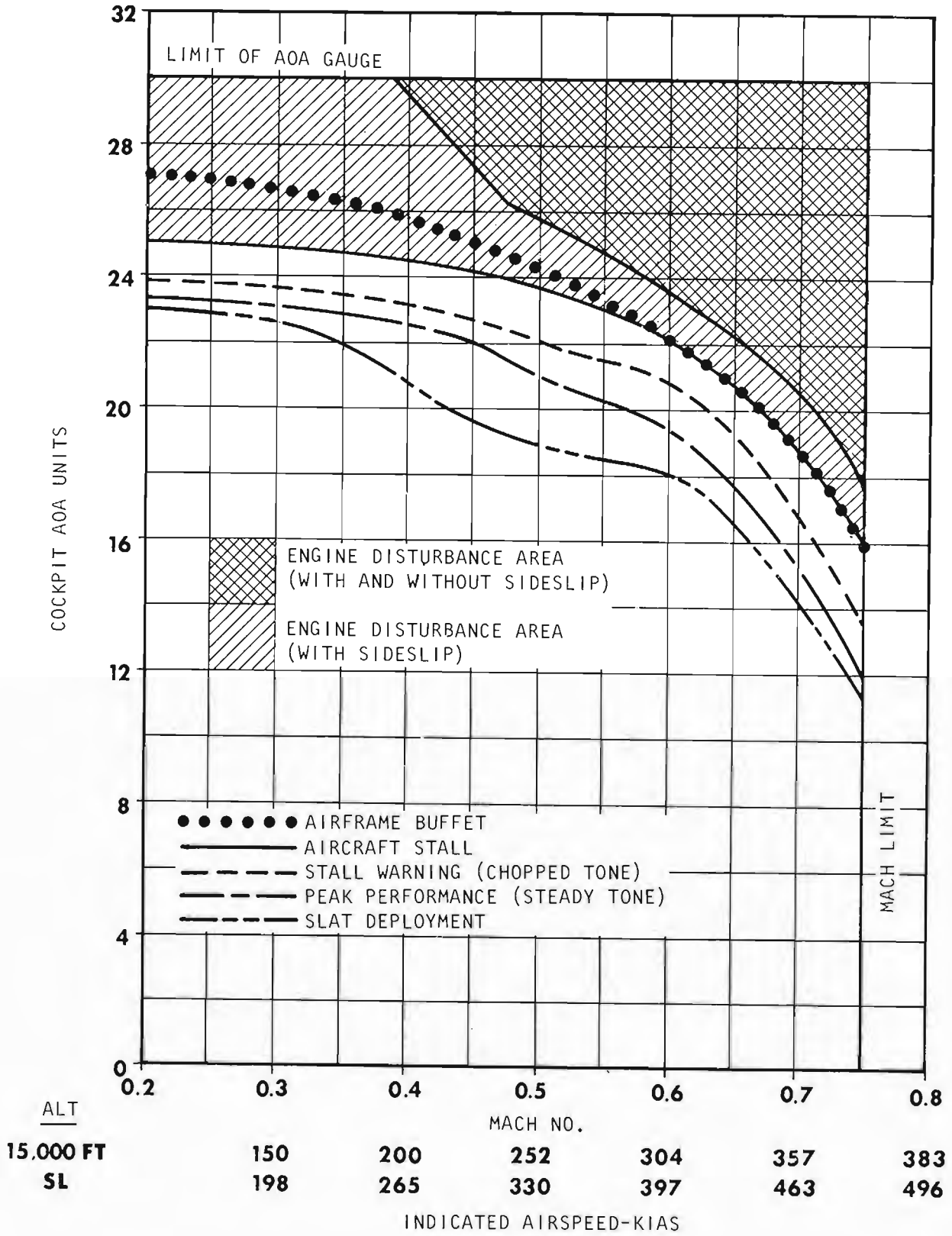

Figure 6-2

A1-10A-6-1

POST-STALL GYRATIONS

PSGs are large, uncommanded, random motions about one or more aircraft axes. All A-10 PSGs are uncommanded roll reversals or roll accelerations produced at sideslip angles in excess of 20°. Full aileron or crossed controls maintained for at least 2 seconds after stall will produce the sideslip necessary for a PSG. Departure warning cues prior to PSGs are large sideslip angle and moderate lateral acceleration.

Roll Reversals

Roll reversals are uncommanded rolls opposite to the direction of large aileron input. Excessive sideslip, high lateral acceleration and a hesitation in commanded roll rate normally precede the reversal and serve as warning cues. Abruptly reversing uncommanded roll rates of up to 155 degree/second, sideslip angles of up to 85°, and angles of attack as high as 75° have been recorded during tests where roll reversals were encountered. Maximum load factors during tests ranged from +2.3g to -1.0g; however, larger positive and negative g excursions are theoretically possible. Roll reversal recovery starts immediately upon neutralizing controls with roll rate rapidly decreasing as sideslip angle returns to zero.

Roll Accelerations

Roll accelerations are characterized by a sudden, often violent increase in roll rate. Roll rates may exceed 200° per second. Negative load factors of up to -2g may be experienced. Neutralizing controls will recover the aircraft, but the rolling motion may continue for several turns after neutralization. AOA and load factor oscillations may occur during recovery. Neutral controls must be maintained until all oscillations have ceased. Rushing the recovery may produce an AOA transient above stall AOA and a possible secondary departure. Roll accelerations are normally produced by sustained crossed controls with the aircraft stalled.

SIDESLIP DEPARTURES

Rudder control is sufficient to exceed 25° of sideslip and depart the aircraft at any airspeed below 240 KIAS. Warning cues associated with sideslip departures include very large sideslip angles, high lateral

accelerations, and very light airframe buffet. Immediately prior to departure, the yaw rate will suddenly increase with little or no increase in rudder input. If the warning cues are ignored, a rapid roll will occur in the direction of rudder application. The departure may be avoided or recovered at any time by neutralizing controls. Sideslip departures occur only below stall AOA. At stall AOA or greater, sustained full rudder applications will produce spins.

SPINS

The A-10A is extremely resistant to spins. Full aft stick and full rudder are required to both enter and maintain a spin. Although numerous attempts were made, inverted spins could not be obtained during flight testing and are considered extremely unlikely.

Spin characteristics are not significantly affected by aircraft configuration, store loading, cg position, or SAS operation. Spins with the equivalent of three AGM-65s and one ALQ-119 on the same wing have been tested. During the first turn of unaccelerated entries, the aircraft slowly rolls 180° as the nose slices to approximately 70° nose low. This attitude may appear vertical. Slow roll and nose slice continue until the aircraft is in an upright, nose low attitude after one turn. Accelerated entries are faster and appear primarily as a rolling motion during the first turn. Subsequent turns have an upright, turning motion with one oscillation in both pitch and bank attitude during each turn. These oscillations are greatest with asymmetric store loadings, and least with either 20° of flaps or 80% speed brakes. One turn requires about 5 seconds. If aileron is applied against the spin, the spin will become flat and faster with about 4 seconds per turn. Recovery will then be delayed from 1 - 2 1/4 turns. Full forward stick, during recovery, will result in violent pitch oscillations and is not recommended.

STALL/DEPARTURE/SPIN AVOIDANCE

All out-of-control situations may be avoided by stall/sideslip recognition and immediate control relaxation. Stalls must be severely aggravated to force a spin or PSG. In addition, the following will aid in avoiding inadvertent stalls, departures, PSGs, or spins:

1. Rudder rolls are not recommended. Aileron control is excellent at all AOA's and produces much better roll performance.
2. Avoid full rudder sideslips and abrupt rudder reversals.

3. Leading large aileron inputs at high AOA with rudder will augment the SAS to reduce sideslip buildup from adverse yaw and will improve rolling performance.

4. Natural stall warning is inadequate. Monitoring AOA and stall warning devices will aid in avoiding stalls.

OUT-OF-CONTROL RECOVERY CHARACTERISTICS

The out-of-control recovery procedure of throttles - IDLE and controls - neutral will recover the A-10A from all out-of-control situations, including spins. The optimum spin recovery technique includes full rudder opposite the spin direction. Recoveries from PSGs may require as many as 2 roll revolutions followed by a rapid reduction in yaw rate, roll rate and load factors during return to controlled flight. Elevator must be maintained neutral until oscillation stops to avoid secondary stalls during PSG recoveries. Spin recoveries are characterized by an immediate decrease in yaw rate. The last portion of recovery may resemble a slow roll in a steep, nose-down attitude. Motion will stop with either neutral controls or opposite rudder with no tendency to reverse directions.

Ailerons with the spin, during spins or spin recoveries, are unacceptable because of a rapid transition to a roll acceleration PSG. Recoveries are not affected by flap or speed brake position, with or without the SAS engaged. The effect of the landing gear during spins is unknown; retraction is recommended if recovery is not immediate.

Since PSG and spin recoveries normally result in a steep, nose-down attitude, the dive recovery technique is critical in minimizing altitude lost. Use of AOA to optimize recovery is recommended. PSG recoveries require from less than 1,000 to as much as 8,000 feet altitude. Spin recoveries require from 4,000 - 6,000 feet altitude, for incipient, half-turn spins, and 10,000 feet altitude for three-turn developed spins.

WARNING

- Engine disturbances during PSG are common, and with the Mach Alpha continuous ignition TCTO incorporated, will normally result in engine(s) overtemperature or engine(s) stall stagnation following the maneuver, requiring engine(s) shutdown and restart.

MANUAL REVERSION SPIN RECOVERY

If hydraulic power is lost during a spin, the aircraft can be recovered using manual reversion controls. Although high stick and rudder forces are required, the spin recovery characteristics are similar to those with the powered system. Up to 300 pounds of rudder pedal force and 150 pounds of forward stick force (to bring elevators to neutral) may be required for recovery. Switching to MAN REVERSION on the flight control mode switch is not necessary for spin recovery. However, selecting MAN REVERSION will provide roll control for the ensuing dive recovery.

SINGLE-ENGINE FLIGHT CHARACTERISTICS

The A-10A single-engine flight characteristics differ from dual-engine flight characteristics in three basic areas. First, single-engine operation results in asymmetric thrust requiring application of rudder opposite the dead engine to maintain coordinated flight. Second, the loss of one hydraulic system reduces total rudder authority and results in a 50% reduction in yaw trim authority. Third, the yaw SAS will disengage when a difference in rudder displacement is exceeded. This results in loss of automatic turn coordination, rudder trim, and yaw damping. The operative yaw SAS channel may be reengaged to regain 50% of these losses.

TAKEOFF

If an engine failure or fire occurs during takeoff, the pilot must immediately decide whether to continue the takeoff or to abort. Below 70 KIAS, flight control inputs may be inadequate to maintain control of the aircraft with one engine at MAX and the other engine failed. In this case, an abort is the only option. Above continuation speed (minimum go-speed) but below refusal speed, it is possible to continue the takeoff. However, an abort is normally the preferable option. If an abort is not possible, both throttles should remain at MAX until a safe altitude is attained. If an engine failure is experienced, gear retraction should be accomplished promptly once safely airborne in order to enhance acceleration and climb performance and to take advantage of any residual hydraulic pressure. Single-engine rate of climb at takeoff is increased 400 FPM (500 FPM at best rate of climb speed) if the gear is retracted. If experiencing an engine failure after takeoff with the gear down and below best single-engine climb speed, it may be impossible to accelerate to best single-engine climb speed. A pilot can anticipate the loss of approximately 10 knots of airspeed when an engine fails on takeoff. Fully retracting the flaps will increase single-engine climb

rate by 100 FPM (150 FPM at best rate of climb speed) but will also decrease stall margin at low airspeed. Therefore, if climb performance allows, full retraction should be delayed until above 150 KIAS. The retention of external stores located opposite the failed engine may help the pilot control the asymmetric thrust. However, the drag and weight associated with external stores may, under certain circumstances, make it impossible to accelerate to single-engine climb speed if an engine fails immediately after takeoff. Thus, jettison of external stores is critical.

During the initial takeoff roll, fan speed should be checked after approximately 1,000 feet. Since fan speed is a direct indication of thrust, obtaining the correct minimum acceptable fan speed is necessary to obtain the performance shown in this technical order for maximum power takeoff. Fan speeds less than the predicted fan speed will result in reduced single-engine acceleration to best single-engine climb speed and will adversely affect other takeoff parameters. Under critical operating conditions (short runway, high gross weight, high temperature/pressure altitude, etc.), an abort may be the appropriate action if predicted fan speed cannot be achieved.

If an engine failure is experienced shortly after takeoff, the thrust required to accelerate to best single-engine climb speed may be greater than thrust available. As a result, the pilot may be required to lower the nose of the aircraft in an attempt to exchange altitude for airspeed. An engine failure at extremely low altitudes (just after lift-off) may preclude this option. If the pilot elects to trade altitude for airspeed in an attempt to achieve best single-engine climb airspeed, he must be conscious of the terrain in front of him. Single-engine acceleration rates under certain conditions (high temperatures/pressure altitudes and heavy gross weights) are very slow with a corresponding small vertical climb potential. A near level attitude should be maintained while accelerating to a minimum of best single-engine climb speed. Accelerate and climb straight ahead if terrain permits. If turns are necessary, they should be made into the good engine, if possible, and a minimum practical bank angle (any turns will degrade aircraft performance). Best single-engine performance is achieved with a slight bank (up to 5°) into the good engine and rudder, as required, to maintain a constant heading. The ball will be displaced toward the good engine, proportional to the amount of bank used. It is essential that yaw rates be controlled

through proper use of rudder and bank into the good engine (center the turn needle). This will increase climb potential, as well as reducing the possibility of a yaw departure. Failure of the number two engine with a corresponding loss of right hydraulic pressure will result in a further degraded climb/acceleration potential as a result of the slats extending (2.02 units of drag). A further increase in drag could result due to pitch and yaw transients as the SAS disengages. Also, a "wallowing" effect can be encountered as the pilot overcorrects for asymmetric thrust as hydraulic pressure and engine thrust is lost. Yaw in excess of 8° - 10° will increase drag adversely affecting airspeed and acceleration. All these factors can combine to prevent acceleration while in a climb or, in certain conditions, level flight.

IN FLIGHT

Control can be maintained while flying on one engine throughout the flight envelope. Moderate rudder must be held opposing the failed engine to reduce sideslip, because the engines are significantly offset from the aircraft centerline. A slight bank angle into the good engine will reduce the amount of rudder required to hold a constant heading, and will reduce pilot workload for prolonged single-engine flight. Yaw trim is available as long as the yaw SAS channel corresponding to the operating engine is engaged. Single channel yaw damping and automatic turn coordination will also be provided. However, single channel rudder authority for turn coordination for sideslip control is not sufficient and pilot rudder inputs opposite the failed engine will be required.

Under steady-state flight conditions, the flight controls provide adequate response to maintain aircraft control down to stall speed, even with maximum power on the good engine. However, under maneuvering flight conditions of high sideslip angles, adverse yaw rates, and high bank angles, adequate flight control response may not be available to effect an immediate recovery. With symmetric store loads, gear down and flaps up, the maximum amount of powered rudder required to maintain a steady heading down to stall speed is approximately half the available rudder. Full rudder may be required to maintain heading at stall speed if the gear is down and flaps are down 20° at light gross weights. Asymmetric store loadings and/or crosswinds on the side of the good engine will help reduce the amount of rudder required. Performance considerations should override handling qualities when making the decision to selectively jettison stores.

WARNING

- A combination of high gross weight, high pressure altitude, and high temperature may create a condition in which level flight is not possible with gear extended. Increases in AOA result in decreases in rudder effectiveness, decreases in airspeed, and increases in sideslip angle. This produces an increase in yawing moment that must be compensated for by increasing rudder into the good engine. If the additional rudder is not applied, the aircraft will rotate to a higher sideslip angle, further decreasing the airspeed. The problem is compounded by the fact that to maintain airspeed, thrust on the good engine must be increased, further increasing the sideslip angle. The pilot should, therefore, closely monitor airspeed and aircraft attitude, and maintain rudder opposing the failed engine to reduce the sideslip angle.

During single-engine approaches, avoid abrupt control inputs. This is particularly important when the SAS is off, since additional amounts of sideslip will

be generated during banking maneuvers unless the pilot coordinates the turn with rudder. All maneuvering turns should be made into the good engine, if possible. Bank angle should not exceed 30°, and g loading should be minimized. If it is necessary to turn the aircraft into the failed engine, relaxation of opposite rudder will be required to coordinate the turn. The amount of rudder required to control the yawing moment due to engine thrust, plus the additional rudder required to coordinate turns into the operating engine, may be substantial and will require close pilot attention to insure that decreases in airspeed and increases in sideslip are not excessive.

WARNING

- During single-engine approaches, failure to use sufficient rudder during maneuvering turns can result in large sideslip angles and yaw rates. It is possible to create a condition where the yaw rate becomes so high that there is insufficient rudder available to correct it, and the aircraft will depart controlled flight. All flight control inputs should be made with constant pilot attention to turn coordination and maintaining approach airspeed.

MANUAL REVERSION SINGLE-ENGINE FLIGHT CHARACTERISTICS

Manual reversion single-engine flight is a very demanding task. The limited aileron and rudder authority in manual reversion make countering the roll moment due to asymmetric thrust difficult. If manual reversion flight becomes necessary when operating with a single-engine, thrust should be reduced as low as possible prior to transition. Rudder and aileron into the good engine should precede addition of thrust. High rudder forces will be required, as will moderate to high aileron forces, to maintain steady heading flight. Some sideslip will have to be maintained in cruise flight. Maneuvers should be planned to avoid turns into the dead engine. Some bank into the good engine will reduce rudder required to maintain heading. Single-engine manual reversion landings have not been tested due to safety considerations.

Simulated single-engine manual reversion landings have been accomplished with one engine at IDLE. Actual single-engine manual reversion go-arounds have been tested at altitude and are very difficult to perform. Power has to be applied very slowly as rudder and ailerons are blended in. A light asymmetric store loading on the side of the good engine may help reduce control forces, while stores on the side of the dead engine will increase control forces and should be jettisoned. Five degrees of bank into the good engine will reduce rudder forces, but will also reduce available roll rate into the good engine. An ECM pod or similar asymmetric load on the dead engine side will decrease the full aileron roll rate into the good engine to less than 5° per second, which may be inadequate to retain control of the aircraft for landing in gusty conditions. Minimum single-engine control speed in manual reversion is 130 KIAS. This was determined as the physical limit of the pilot. Individual aircraft and pilot differences may require higher speeds.

ENGINE OPERATION

Engine compressor stalls may be encountered due to ingestion of turbulent airflow during operation where the aircraft stall AOA has been exceeded. The following types of compressor stalls may be encountered:

1. Minor compressor stall -- Characterized by a momentary decrease in compressor discharge pressure accompanied by a slight ITT increase which in most cases is undetectable by the pilot and is self-recoverable without pilot action.
2. Unrecoverable compressor stall -- Characterized by a rapid increase in ITT requiring immediate pilot action to prevent an overtemperature condition.
3. Flameout.

Leading edge slats have been incorporated to delay the onset of engine disturbances to a higher AOA. However, if the aircraft is flown into a stall, the engine will ingest turbulent flow which may cause a compressor stall in one of the above categories. Two warning signals (aural tones) are incorporated to assist the pilot in checking any maneuver prior to wing stall AOA. The first (steady) tone signifies that the maximum usable lift of the wing (peak performance) is approaching. The second (chopped) tone indicates the top of the regime of peak performance, and that if AOA is allowed to increase still further, a wing stall will occur. If these warnings are ignored, and the AOA is permitted to rise above the wing stall, an engine compressor stall may also result depending on the degree of severity of the maneuver.

As shown in figure 6-2, the engine is less tolerant to post-stall inlet disturbance as Mach number is increased. Compressor stalls are less likely below approximately 0.5 Mach due to the increased disturbance margin. High Mach number buffet masks the stall characteristics making it easier to enter the engine disturbance regime inadvertently. The engine becomes more tolerant to aircraft post-stall inlet disturbances as altitude decreases. Maneuvering with high sideslip will significantly decrease the engine operating envelope.

NOTE

- Certain engines may exhibit a characteristic of slow or limited acceleration from low power at high altitude (usually above 25,000 feet). The condition can result in either a long time period elapsing (over 1 minute) to accelerate an engine(s) to maximum power parameters from a low power setting

or of not reaching maximum power parameters unless a descent to lower altitude is made. Overtemperature should not occur nor should any engine damage be sustained.

FAILURE MODE FLIGHT CHARACTERISTICS

The many redundant features of the A-10 flight control system made testing of all failures impossible. When faced with multiple failures, the pilot should perform a controllability check in the landing configuration prior to attempting a landing.

LOSS OF ONE PITCH MECHANICAL COMMAND PATH

In the case of a severed control cable the pitch response and feel to the pilot is no different than with both mechanical paths operating.

SINGLE OPERABLE ELEVATOR

With the exception of a full-up jammed elevator, which has been disconnected, the aircraft can be mildly maneuvered and landed with a single operable elevator. With a full-down jammed elevator a controllability check should be made to determine the minimum control speed.

Elevator stick forces appear lighter than normal to the pilot; however, twice the stick displacement is required to achieve a given pitch rate or g. Trim rates in the single elevator mode appear to the pilot to be cut in half.

SINGLE OPERABLE AILERON

With one aileron disconnected or control path severed, the remaining operable aileron has sufficient authority to control the aircraft, provided hydraulic power is available. With stick deflections less than one half of full throw, roll rates are about the same in either direction. For more than one half stick deflection, the roll rate toward the operable aileron increases to about twice that away from the operable aileron. Sufficient control is available to land the aircraft with light to moderate pilot workload. If one aileron is inoperative due to a severed control path, it may still be trimmable, as long as the electrical circuits remain intact.

WARNING

- Flight in manual reversion with one aileron disconnected has not been tested and may be impossible.

LOSS OF MECHANICAL COMMAND PATHS TO RUDDERS

Loss of rudder command is of little consequence in the A-10 as long as symmetric flight is maintained. If the SAS is still engaged, the rudders can be controlled by means of rudder trim as long as the electrical path remains intact. The yaw SAS will continue to function normally with a functioning electrical path.

LOSS OF ALL MECHANICAL COMMAND PATHS AND HYDRAULICS ON ONE SIDE

The aircraft in this condition handles just like an A-10 with a single operable aileron. Turn coordination is still provided by the ARI on [83] and by the Beta Dot SAS on [84] through the operable rudder if the corresponding yaw SAS channel is engaged. If SAS is off, the aircraft will tend to dutch roll whenever aileron inputs are made and this condition is aggravated with gear and flaps DN. If yaw SAS cannot be maintained, then slow, shallow turns should be made while avoiding rapid power changes.

RUNAWAY TRIM

Runaway pitch trim is easily controlled throughout the powered control flight regime. Maximum forces required can be expected to be on the order of

10 - 15 pounds aft force for full forward runaway trim and about 25 pounds forward force for full aft runaway trim.

Full runaway roll trim requires about 10 - 15 pounds of side stick force to counteract. If either pitch or roll runaway trim is encountered, the pitch/roll trim override switch, on the emergency flight control panel, should be placed in EMER OVERRIDE and the emergency pitch and roll trim switch should be used to trim out the forces.

Runaway rudder trim is easily controlled with opposite rudder. Disengaging the yaw SAS will cut out rudder trim completely.

Runaway pitch trim in manual reversion has been tested. At all but the lowest speeds attainable, runaway trim would be uncontrollable in this flight mode if control is not regained using emergency override.

FLAP ASYMMETRY

Tests have been conducted with both right flap sections locked up and left flaps extended to MVR, full DN, and emergency retract positions. With gear DN, the aircraft is trimmable to a hands-off condition. In the case of 20° flaps, however, it was not possible to reduce sideslip to zero with trim alone.

SECTION VII

ADVERSE WEATHER OPERATION

TABLE OF CONTENTS

Introduction	7-1	Night Flying	7-3
Turbulence and Thunderstorms	7-1	Cold Weather Operation	7-4
Ice and Rain	7-2	Hot Weather and Desert Operation	7-5

INTRODUCTION

This section consists of procedures and information which differ from, or are supplementary to, the normal operating and instrument flight procedures in Section II. Except for some repetition necessary for emphasis or clarity, only those procedures required for all-weather operation are discussed.

TURBULENCE AND THUNDERSTORMS



- Intentional flight through thunderstorms, hail, or known severe turbulence is not recommended. Flights into these areas increase the danger of engine flameout and aircraft damage.

The key to proper flight technique through severe thunderstorm activity and turbulence is attitude. Both pitch and bank should be controlled by reference to the attitude indicator.

If flight through severe turbulence or thunderstorms is unavoidable, establish and maintain a power set-

ting and pitch attitude that will hold the aircraft in level flight at 200 KIAS or cruise airspeed, whichever is lower. Trim the aircraft at this speed. Throttle setting and pitch attitude, if maintained throughout the severe activity, will normally result in constant airspeed regardless of any false readings of the airspeed indicator. Do not chase the airspeed.

NOTE

- Be alert for possible instrument failures. Maintain a constant crosscheck between the main attitude indicator and the standby.

Do not change trim after the proper attitude has been established. Extreme gusts will cause large attitude changes. Use smooth and moderate aileron and elevator control inputs to reestablish the desired aircraft attitude.

Severe vertical gust may cause appreciable altitude deviations. Allow the altitude to vary. Continue to maintain desired attitude and do not chase the altimeter and VVI.

Concentrate on maintaining a constant heading. Do not make any turns unless absolutely necessary.

T.O. 1A-10A-1

Should flight through an area of severe turbulence or thunderstorm activity become necessary, the following procedure is recommended:

1. Turn on pitot heat, tighten safety belt, lock shoulder harness, and stow loose items.
2. Recheck windshield anti-ice — ON.
3. Rain removal — ON (if required).
4. Thunderstorm lights — ON (if required).

ICE AND RAIN

WARNING

- Flight into areas of known moderate or severe icing is not recommended.

The airplane is equipped with a windshield and canopy defogging system, windshield rain removal system, pitot heater, AOA vane heater, and a lift transducer heater. Engine inlet icing and anti-icing or deicing system for the wings and empennage are not provided. Sustained flight through areas of known icing should be avoided when possible. However, short duration icing (approximately 1/4 inch) can be tolerated without significant damage to fan blades due to shedding. When icing is encountered, a change in altitude or course should be made to prevent ice from accumulating on the airframe and engine inlets. If circumstances preclude sublimation at altitude, avoid rapid (penetration type) descent rates if possible. Rapid descent rates will cause accumulated ice to break off in large chunks.

Experience has shown that shedding of ice from the airframe or engine inlet can result in damage to fan blades, and replacement of damaged fan blades may be required. If flight through icing occurs, appropriate entry in AFTO Form 781 is required, and the engine must be inspected after landing for possible damage.

Accumulations of up to 3/4 inch of ice do not significantly increase stall speed, but the stall break will be masked in the clean configuration as a result of ice on the stall strips. Power on approach stall characteristics do not change. However, heavy icing may result in improper leading edge slat operation, change of stall speed, or engine disturbances in the

stall/post stall regime. Windshield anti-ice and the pitot heat system are very effective even in severe icing conditions, if they are on prior to encountering ice.

If operational requirements dictate flying in icing conditions:

1. Recheck pitot heat and windshield defog/deice are on.
2. Adjust cockpit temperature and canopy defog flow to maximum consistent with pilot comfort to aid in quarter panel and canopy anti-icing and deicing.
3. Minimize exposure time to prevent larger buildup of ice on aircraft structure and engine intakes.
4. Avoid rapid descent rates with accumulated airframe or engine intake ice.

HYDROPLANING

Dynamic hydroplaning is a condition where the tires of the airplane are separated from the runway surface by a fluid. Under conditions of total dynamic hydroplaning, the hydrodynamic pressures between the tires and runway lift the tires off the runway to the extent that wheel rotation slows or actually stops. When an airplane is subjected to hydroplaning to any degree, directional control becomes difficult. Under total dynamic hydroplaning conditions, nosewheel steering is ineffective and wheel braking is nonexistent. The major factors in determining when an airplane will hydroplane are groundspeed, tire pressure, and depth of water on the surface. To a lesser degree, the surface texture, type of tire, and tire tread depth influence the speed for the onset of hydroplaning. Total dynamic hydroplaning of the nosewheel with 0.1 inch or more of water or slush on the runway can be expected at approximately 91 knots groundspeed based on a tire pressure of 140 psi and nonrotation at touchdown. Main landing gear tires are inflated for the heaviest weight mission to be flown for the day. The speed for total dynamic hydroplaning of the main wheels therefore depends on this weight. Main wheel hydroplaning speed is given in the following chart for takeoff weight and corresponding tire pressure (nonrotation at touchdown).

Aircraft Gross Weight	MLG Tire Inflation Pressure	Total Dynamic Hydroplaning Speed
Pounds	psi	Knots
31,500	155(±5)	81
41,500	185(±5)	95
48,000	185(±5)	104

Partial dynamic hydroplaning occurs to varying degrees below these speeds. Once dynamic hydroplaning has been established, it can continue at speeds below the onset speed and in water shallower than onset depth.

In addition to dynamic, two other types of hydroplaning can occur:

1. Viscous hydroplaning is caused by a thin film of water mixed with contaminants such as oil, JP-4, rubber deposits and/or dust, and can occur at speeds less than those associated with dynamic hydroplaning. Tire pressure and wheel loading have little effect on viscous hydroplaning.

2. Reverted rubber hydroplaning is caused by a locked-wheel skid on a wet surface which lasts long enough to heat the rubber sufficiently to revert it to its natural state and seal the tire grooves, delaying water dispersal. Once rubber reversion is well established, the combination of water film and uncured tire will sustain a skid down to approximately 10 knots.

When possible hydroplaning conditions exist, pilots should be aware of the following:

1. Smooth tires tend to hydroplane with as little as 0.08 inch of water. New tires tend to release hydroplaning pressures and will require in excess of 0.2 inch of water depth to hydroplane.

2. Takeoffs with crosswinds on water covered runways should be made with caution. An aborted takeoff on a wet runway initiated at or near hydroplaning speed will require considerably more runway than a dry runway abort and directional control of the airplane will be critical until the speed has decreased below hydroplaning velocity.

3. In the absence of accurately measured runway water depths, pilots may use the following information to determine the possibility of hydroplaning when landing must be accomplished on a wet runway that does not have a porous surface or is not grooved:

- a. Rain reported as LIGHT — Dynamic hydroplaning unlikely, viscous and reverted rubber hydroplaning are possible.

- b. Rain reported as MODERATE — All types of hydroplaning are possible. Smooth tires will likely hydroplane; however, new tires are less likely to hydroplane.

- c. Rain reported as HEAVY — Hydroplaning will occur.

When faced with a possible hydroplaning situation, use speeds for a minimum run landing with upward adjustments if gusts are expected. Land on the centerline where the runway crown will provide the least standing water. Plan a firm touchdown near the start of the runway. After touchdown, immediately reduce power to IDLE and extend speed brakes 100%. Maximum aerodynamic braking should be used throughout the landing roll. When directional control is firmly established apply brakes as required. Utilize maximum anti-skid braking if stopping distance is critical. Little, if any, deceleration will be felt initially, but will increase as braking potential improves with lowered speeds.

NIGHT FLYING

Night flight necessitates a high degree of instrument proficiency and more reliance on flight instruments than would be experienced for normal day VFR operation. Otherwise, techniques used in night flying do not differ appreciably from those used in daylight operation.

NOTE

- Reflections from the HUD combining glass may cause a false image of ground lights on the windshield during night flight. These false images can be distracting and should be anticipated, especially in the runway environment.

COLD WEATHER OPERATION

Most cold weather operating difficulties are encountered while on the ground.

NOTE

- Snow, ice, or frost that accumulates on parked aircraft has different characteristics than inflight ice, which accumulates on surfaces normal to airflow. Therefore, do not confuse this discussion with the paragraphs on inflight ice and rain.
- Liquids may enter the gun compartment through drains in ram air cooled avionics bays during rains and during the removal of snow, ice, and slush. Should this occur when the temperature is subfreezing, ice may form on the gun system and ammunition. If there is a possibility this could have occurred: (1) an inspection should be conducted, (2) visible ice should be removed, and (3) the gun system should be operated manually prior to flight.

EXTERIOR INSPECTION

Snow, ice, and frost shall be removed from all surfaces prior to flight.

WARNING

- Ensure that all vent lines, pitot tube, AOA vane, and static ports are free from obstruction. Check that all ice and slush is removed from landing gears, actuating pistons, and limit switches. Inspect aircraft carefully for fuel and hydraulic leaks caused by contraction of fittings or shrinkage of packings.
- The effects of snow, ice, and frost on A-10A performance has not been tested. Experience on other types of aircraft indicates these phenomena could vary stall speeds significantly.

COLD WEATHER PROCEDURE

In extreme cold weather (-10°F or below), the following steps may be taken prior to completing

the walk-around to ensure the ATS valve is not frozen and to allow cockpit components to warm adequately:

1. Check APU exhaust pipe — Clear.
2. Check ECS and engine covers — Removed.
3. Battery switch — PWR.
4. Fire lights and caution panel — Check.
5. APU — START.
6. APU generator switch — PWR.
7. Inverter switch — STBY.
8. Left engine operate switch — MOTOR until fan turns.
9. Left engine operate switch — NORM.
10. Right engine operate switch — MOTOR until fan turns.
11. Right engine operate switch — NORM.
12. TEMP/PRESS control switch — DUMP.
13. TEMP level — HI.
14. INS — Align (as desired).
15. Complete the exterior inspection.

WARNING

- Avoid the APU exhaust pipe during the exterior inspection, since it will be hot with the APU running.

NOTE

- If the engine core rpm does not indicate rotation, external heat should be applied to the ATS valve. If the engine core rpm begins to rise but fan rotation does not begin by 30% core rpm, inspect the fans for freedom of rotation.

PRIOR TO ENGINE START

To conserve the battery, use external power if available. If APU/battery start must be made in extremely cold weather, use a warm battery. If a warm battery is not available, attempt APU start. If start is unsuccessful, wait 5 minutes and attempt a restart. The initial battery current drain can warm the battery sufficiently to accomplish a successful start. APU starting characteristics may be improved by starting the APU prior to placing the inverter switch to STBY.

CAUTION

- Without external power, bleed air leak detection will not be available, subsequent to APU start, until the APU generator switch is placed to PWR or the inverter switch is placed to STBY.

STARTING ENGINES

Engine starts made under low ambient temperature conditions will result in maximum gauge oil pressure (100 psi). The time required for oil pressure to return to normal depends on throttle setting. There are no restrictions on high power settings following low temperature starts. Shut down engine if oil pressure does not decrease toward normal limits within 2.5 minutes. Before starting use ground heater units to remove any ice from fan inlet. During extremely cold weather the generators may not automatically come on line upon reaching idle speed. If this occurs, reset the generator and allow at least 30 seconds for warmup before advancing the throttle above IDLE.

CAUTION

- When starting the engines in temperatures below 10°F, allow 5 minutes to elapse prior to turning on engine generator(s) to allow for warmup.

BEFORE TAXIING

Check flight controls, flaps, speed brakes and trim for proper operation. Flight controls, flaps, and speed brakes should be cycled until normal operation is observed. At low engine power settings, the APU is required to provide enough airflow to keep cockpit temperature comfortable and provide proper defogging. Use of MAN HOT may be required.

WARNING

- Return temperature control to AUTO prior to advancing engines for takeoff; otherwise very high temperature air will enter the cockpit through the ECS.
- Make sure all instruments have warmed up sufficiently to ensure normal operation. Check for sluggish instruments during taxiing.

CAUTION

- At cold temperatures the canopy may not close fully. Check the canopy seal for accumulated ice and recycle if necessary.

NOTE

- To maintain speed brake actuator warming, place speed brake control to CLOSE.
- To maintain flap actuator warming, place flap lever UP.

TAXI

The aircraft displays good handling characteristics on hard-packed snow and icy surfaces, if speed is kept at a minimum.

CAUTION

- It may be necessary to bring the aircraft to a complete stop before initiating turns.

Avoid taxiing in slush or deep snow before flight. Frozen squat switches may later result in false gear warning indications. Increase the normal interval between aircraft to ensure safe stopping distance and prevent icing of aircraft surfaces with moisture blown by the jet blast of the preceding aircraft. If bare spots exist through the snow, skidding the tires onto them should be avoided.

TAKEOFF

Refused takeoff data should reflect braking capability due to ice and snow on the runway in event of an abort. Make normal takeoff.

NOTE

- At extremely cold temperatures, it may not be possible to perform engine runup during the line up check without skidding. Caution should be exercised during runup.
- At temperature below -20°F , performance of a static engine runup may bottom out the nose strut and cause damage to strut seals.
- At temperatures below 0°F , engine will not reach maximum ITT on engine runup. At -40°F , engine ITT will be approximately 750°C and will increase linearly to approximately $830^{\circ}\text{C}/\boxed{91}$ 865°C .
- Takeoff with ice on main gear or takeoffs from slush-covered runways may result in a red light in gear handle and gear warning horn after retraction. Recycling gear should break off accumulated ice and result in a good up and locked indication. Recycle the gear only if it can be visually determined the gear is not damaged.

- If aircraft has been exposed to subfreezing temperatures, up to 20 seconds may be required for landing gear retraction.
- After takeoff from slush-covered runways, the landing gear should be recycled several times to prevent the possibility of the landing gear freezing in the gear wells during later portions of the flight.

IN FLIGHT**WARNING**

- At extremely cold temperatures, with increased aircraft performance, use caution to avoid flight into the engine disturbance area (see figure 6-2) during high airspeed, high G operations.

LANDING

Make normal approach and landing. Speed brakes should be opened fully after touchdown. If the aircraft starts to skid sideways, the brakes should be released until the aircraft straightens. On slippery runways nose wheel steering is of little use until slow speeds are reached.

When landing on an ice covered runway, make a normal approach and touchdown. Consideration should be given to flying a minimum run approach and landing based on available runway and RCR. Use aerodynamic braking (flaps, speed brakes, and high AOA) during the high speed portion of the rollout. Aerodynamic braking is ineffective below approximately 60 KIAS. Apply wheel brakes as necessary after nosewheel touches down on runway. When RCR is 10 or less, leave the speed brakes extended until aircraft has slowed to turnoff speed.

Reflects TO 1A-10A-1SS-73 dated 30 September 1988.

TO 1A-10A-1

HOT WEATHER AND DESERT OPERATION

Hot weather and desert procedures differ from normal procedures, mainly in that additional precautions must be taken to protect the aircraft from damage caused by high temperatures and dust. Particular care should be taken to prevent the entrance of sand into the various aircraft parts and systems (engine, fuel system, pitot-static systems, etc.). Units with plastic or rubber parts should be protected as much as possible from windblown sand and excessive temperatures. Tires should be checked frequently for signs of blistering or cord separation. Canopy covers should be left off, to prevent sand between the cover and the canopy acting as an abrasive on the plastic.

EXTERIOR INSPECTION

Check exposed portions of shock strut pistons for dust and sand, and have them cleaned if necessary. Check inflation of shock struts and hydraulic accumulators that may have become overinflated because of temperature increases. Check tires carefully for blistering or cord separation, and be sure all protective covers are removed from aircraft.

Check engine nacelle intake for accumulations of dust or sand.

Inspect area behind aircraft to make sure sand or dust will not be blown onto personnel, or equipment, during starting operations.

INTERIOR INSPECTION

Check cockpit for accumulation of dust or sand and have cleaned if necessary.

BEFORE TAKEOFF

Limit use of brakes as much as possible, because brake cooling is reduced when outside air temperatures are high.



- Extended ground operation during hot weather with windshield defogging/deicing system energized may overheat windshield. DEFOG/DEICE should be selected during BEFORE TAKEOFF checks.

NOTE

- At temperatures above 85°F, with the engines at IDLE, the APU must be used on the ground (canopy closed) to provide sufficient cooling to make the cockpit comfortable. Sufficient cold airflow will not be provided until the engine core rpm is above 80%.
- Above 95°F, the CANOPY UNLOCKED light may not go out. Close the canopy and cool the cockpit with APU running at maximum flow, full cold for 15 - 20 minutes to cool the locking mechanism. Recycle the canopy and check CANOPY UNLOCKED light out.

TAKEOFF

A noticeable decrease in thrust occurs at all power settings; therefore, more acceleration time and greater runway distance are required during hot weather operations.

LANDING

Anticipate a longer landing roll resulting from increased touchdown speed.

Reflects TO 1A-10A-1SS-73 dated 30 September 1988.

INSTRUMENT PANEL (TYPICAL)

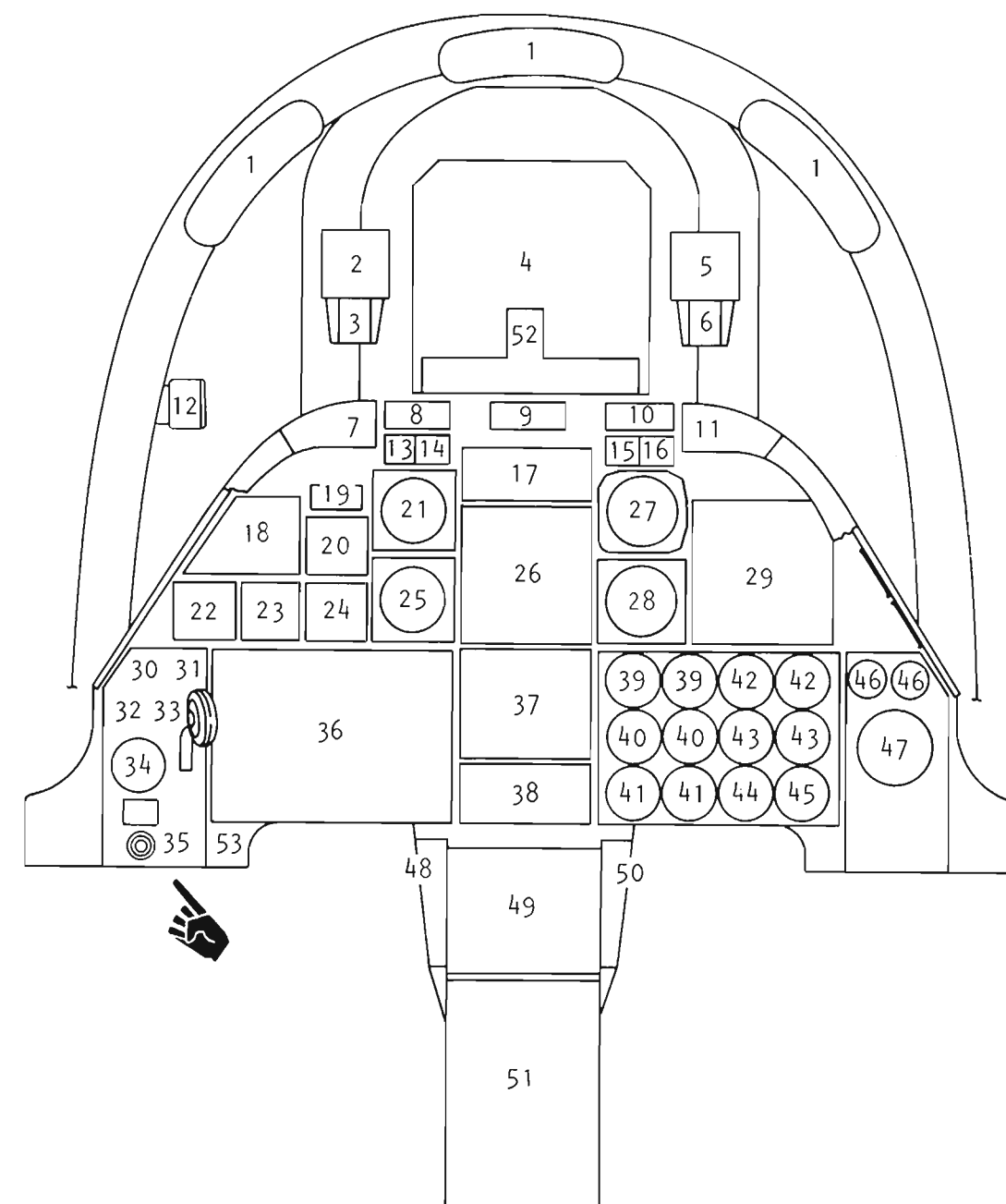
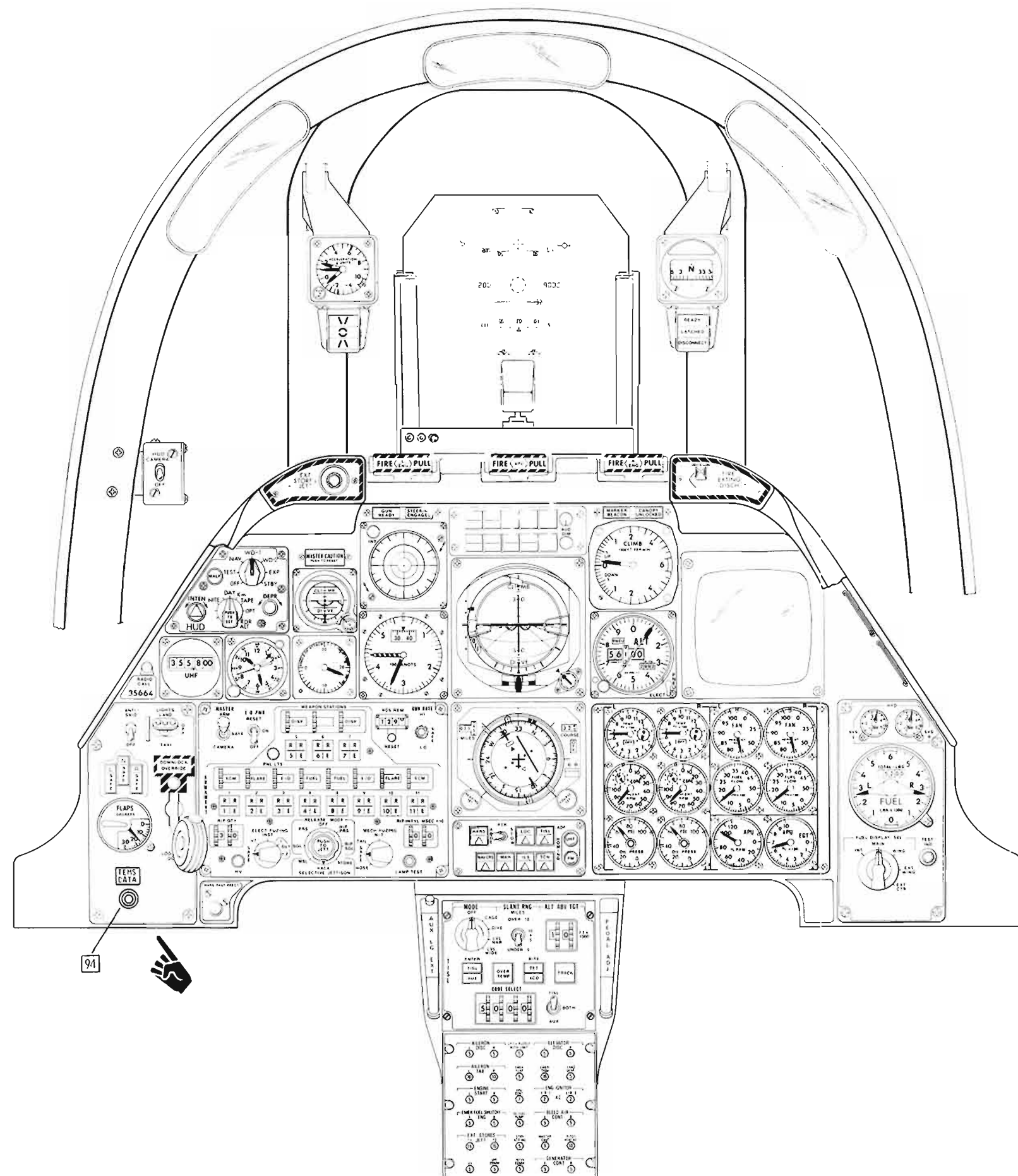



- | | |
|---|--|
| 1. Rear View Mirrors | 29. TV Monitor |
| 2. Accelerometer | 30. Anti-Skid Switch |
| 3. Angle of Attack indexers | 31. Landing/Taxi Lights Switch |
| 4. Head Up Display (HUD) | 32. Landing Gear Position Display |
| 5. Standby Compass | 33. Landing Gear Handle and Override Button |
| 6. Air Refuel Status Lights | 34. Flap Position Indicator |
| 7. External Stores Jettison Switch | 35. TEMS Data Switch  |
| 8. Left Engine Fire Pull Handle | 36. Armament Control Panel |
| 9. APU Fire Pull Handle | 37. Horizontal Situation Indicator (HSI) |
| 10. Right Engine Fire Pull Handle | 38. Navigation Mode Select Panel |
| 11. Fire Extinguishing Agent Discharge Switch | 39. Interstage Turbine Temperature Indicator (L & R) |
| 12. Gun Camera Switch | 40. Engine Core Speed Indicator (L & R) |
| 13. Gun Ready Light | 41. Engine Oil Pressure Indicator (L & R) |
| 14. NoseWheel Steering Engaged Light | 42. Fan Speed Indicator (L & R) |
| 15. Marker Beacon Light | 43. Fuel Flow Indicator |
| 16. Canopy Unlocked Light | 44. APU Tachometer |
| 17. RHAW Control Indicator | 45. APU Temperature Indicator |
| 18. HUD Control Panel | 46. Hydraulic Pressure Gauge (Left Sys & Right Sys) |
| 19. Master Caution Light | 47. Fuel Quantity Indicator |
| 20. Standby Attitude Indicator | 48. Auxiliary Landing Gear Extension Handle |
| 21. RHAW Azimuth Indicator | 49. Laser Spot Seeker Panel |
| 22. UHF Remote Chan/Freq Indicator | 50. Rudder Pedal Adjustment Handle |
| 23. Clock | 51. Essential Circuit Breaker Panel |
| 24. Angle of Attack Indicator | 52. Gun Camera  |
| 25. Airspeed Indicator | CTVS  |
| 26. Attitude Director Indicator (ADI) | 53. HARS Fast Erect Switch |
| 27. Vertical Velocity Indicator | |
| 28. Altimeter | |

Figure FO-1

LEFT CONSOLE (TYPICAL)

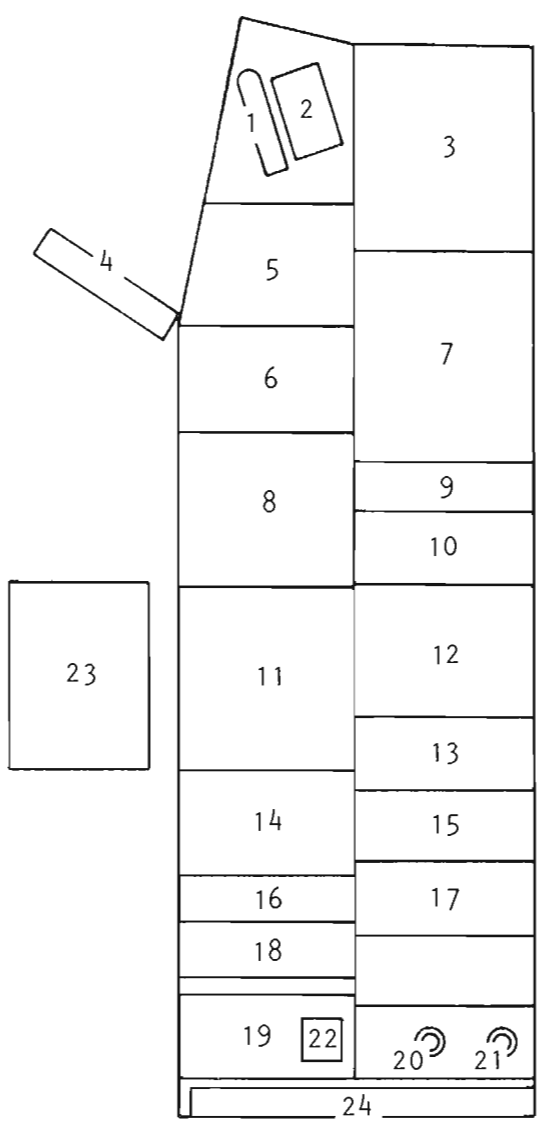
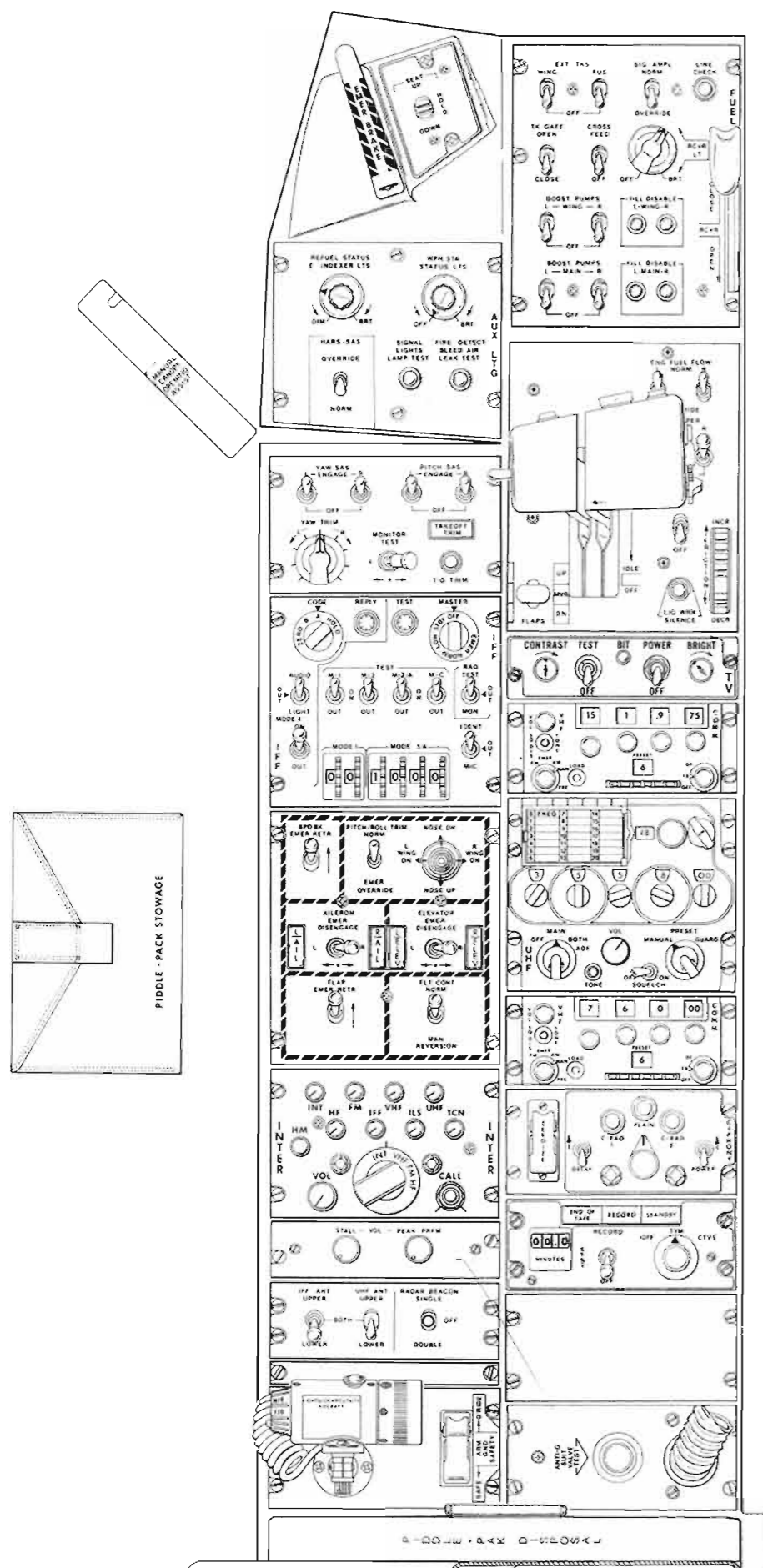

1. Emergency Brake Handle
2. Seat Height Adjustment Switch
3. Fuel System Control Panel
4. Manual Canopy Opening Assist Handle
5. Auxiliary Lighting Control Panel
6. Stability Augmentation System Panel (SAS)
7. Throttle Quadrant
8. IFF Control Panel
9. TV Monitor Control Panel
10. VHF/AM Radio Control Panel
11. Emergency Flight Control Panel
12. UHF Radio Control Panel
13. VHF/FM Radio Control Panel
14. Intercom Control Panel
15. CIPHONY Panel
16. Stall Warning Control Panel
17. CTVS/AVTR Control Panel
18. Antenna Select Panel
19. Utility Light
20. Anti-G Suit Valve Test Button
21. Anti-G Suit Hose
22. Armament Override Switch
23. Piddle Pak Stowage
24. Piddle Pak Disposal

Figure FO-2

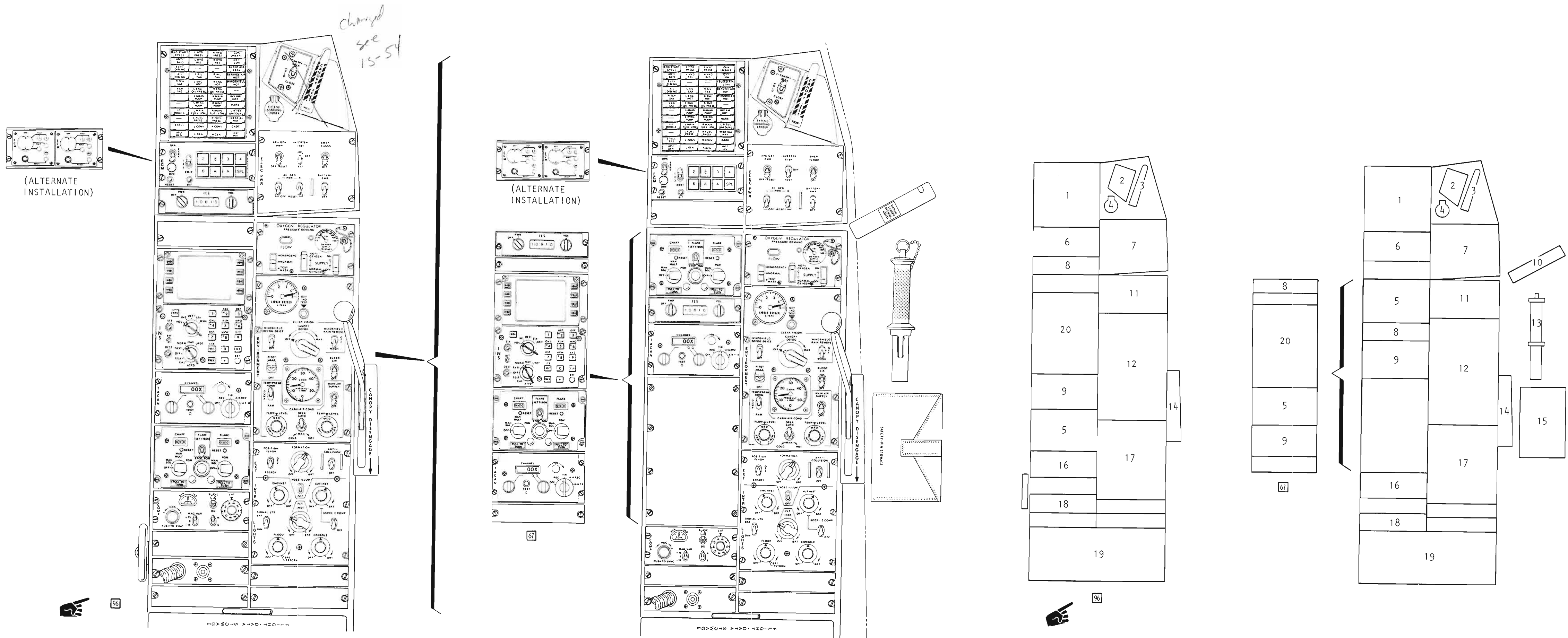

RIGHT CONSOLE (TYPICAL)

1. Caution Light Panel
2. Canopy Control Switch
3. Canopy Jettison Handle
4. Boarding Ladder Extension Button
5. Chaff/Flare Control Panel
6. ECM Panel
7. Electrical Power Panel
8. ILS Control Panel
9. TACAN Control Panel
10. Manual Canopy Opening Assist Handle
11. Oxygen Control Panel
12. Environment Control Panel
13. Canopy Breaker Tool
14. Canopy Actuator Disengage Lever
15. Safety Pin Stowage
16. HARS Control Panel
17. Lighting Control Panel
18. Oxygen Hose and Intercom Connection
19. Flight Data Stowage
20. Control Display Unit (CDU)

Figure FO-3

AIRCRAFT FUEL SYSTEM

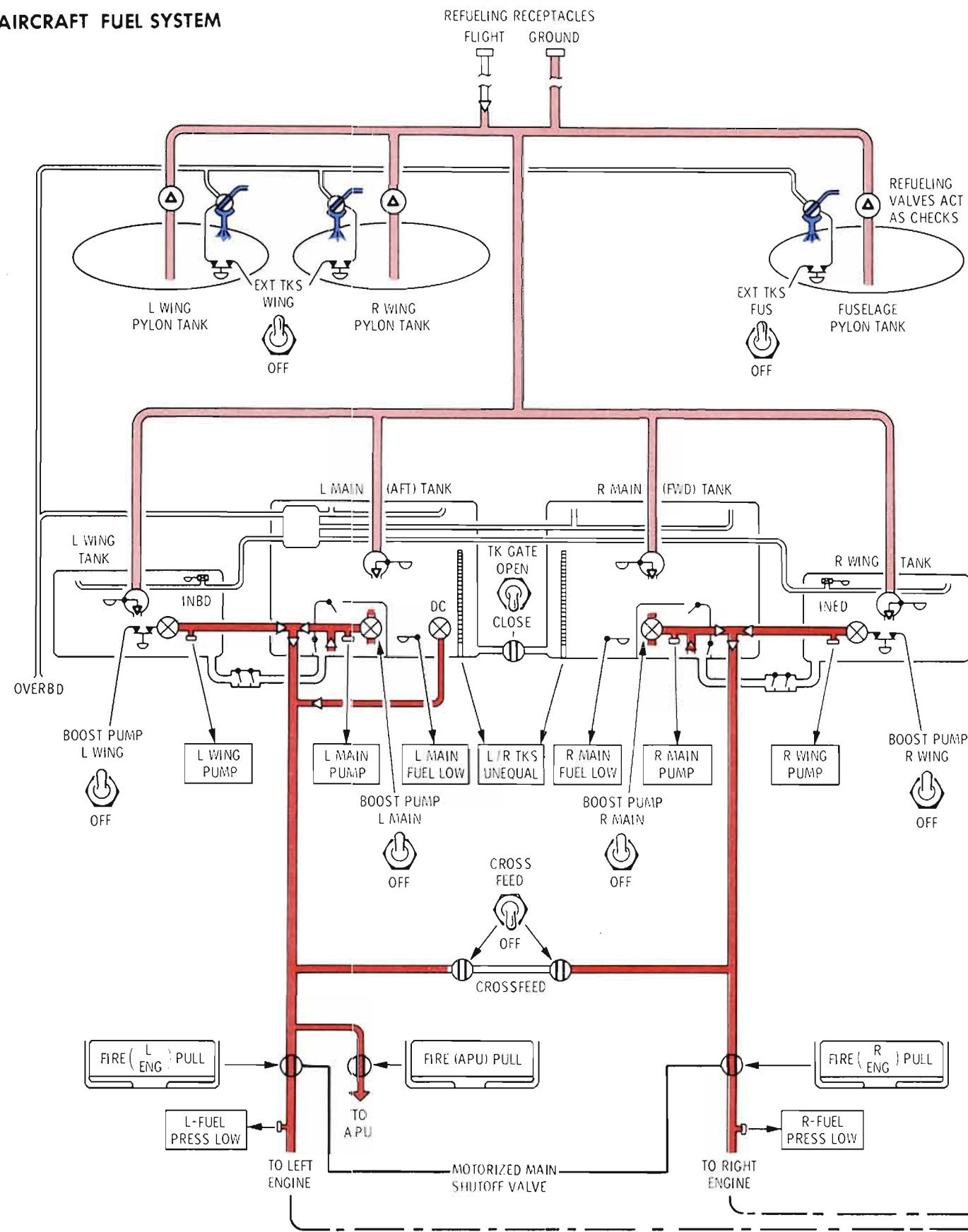

ENGINE FUEL SYSTEM

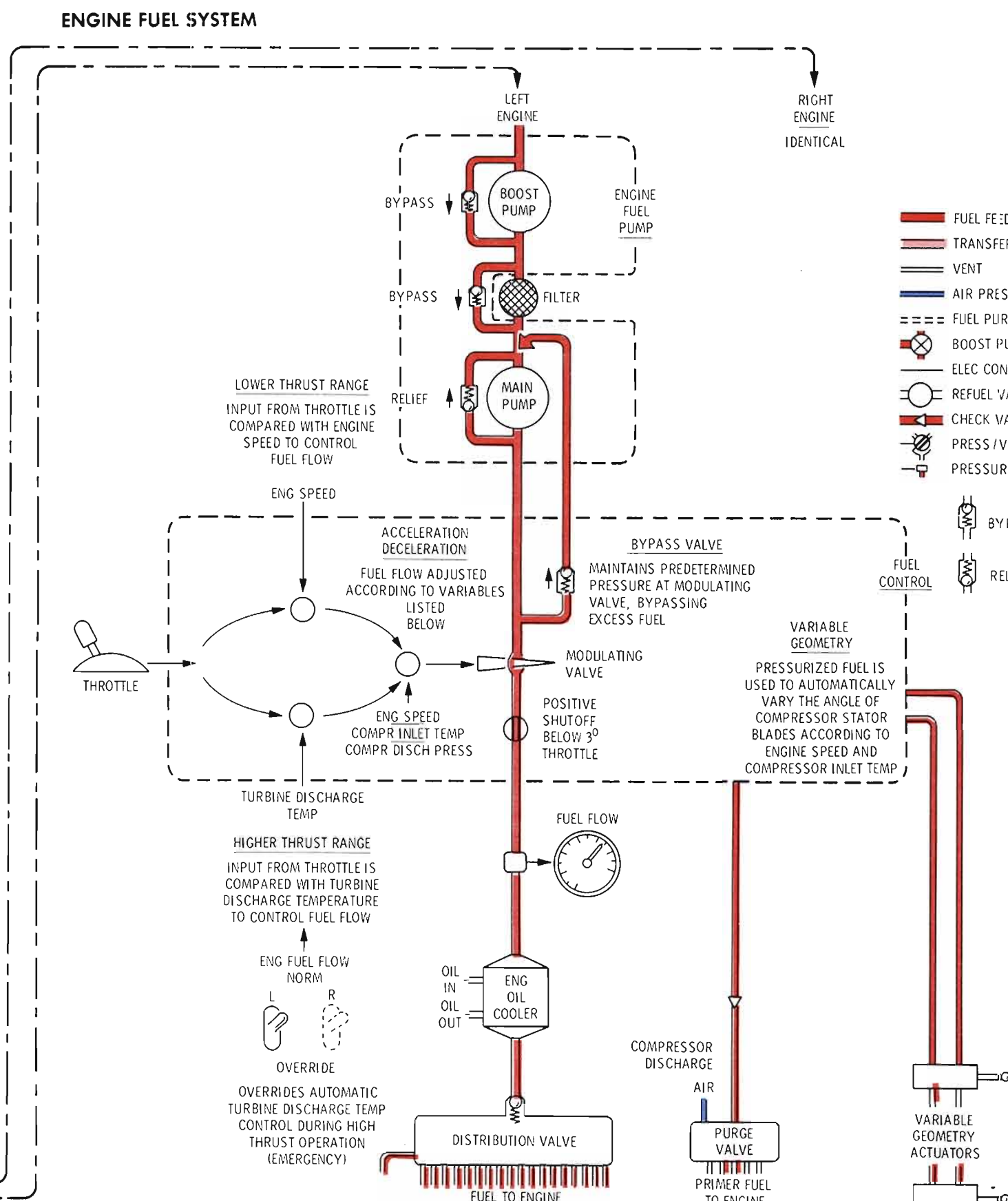

REFUELING SYSTEM

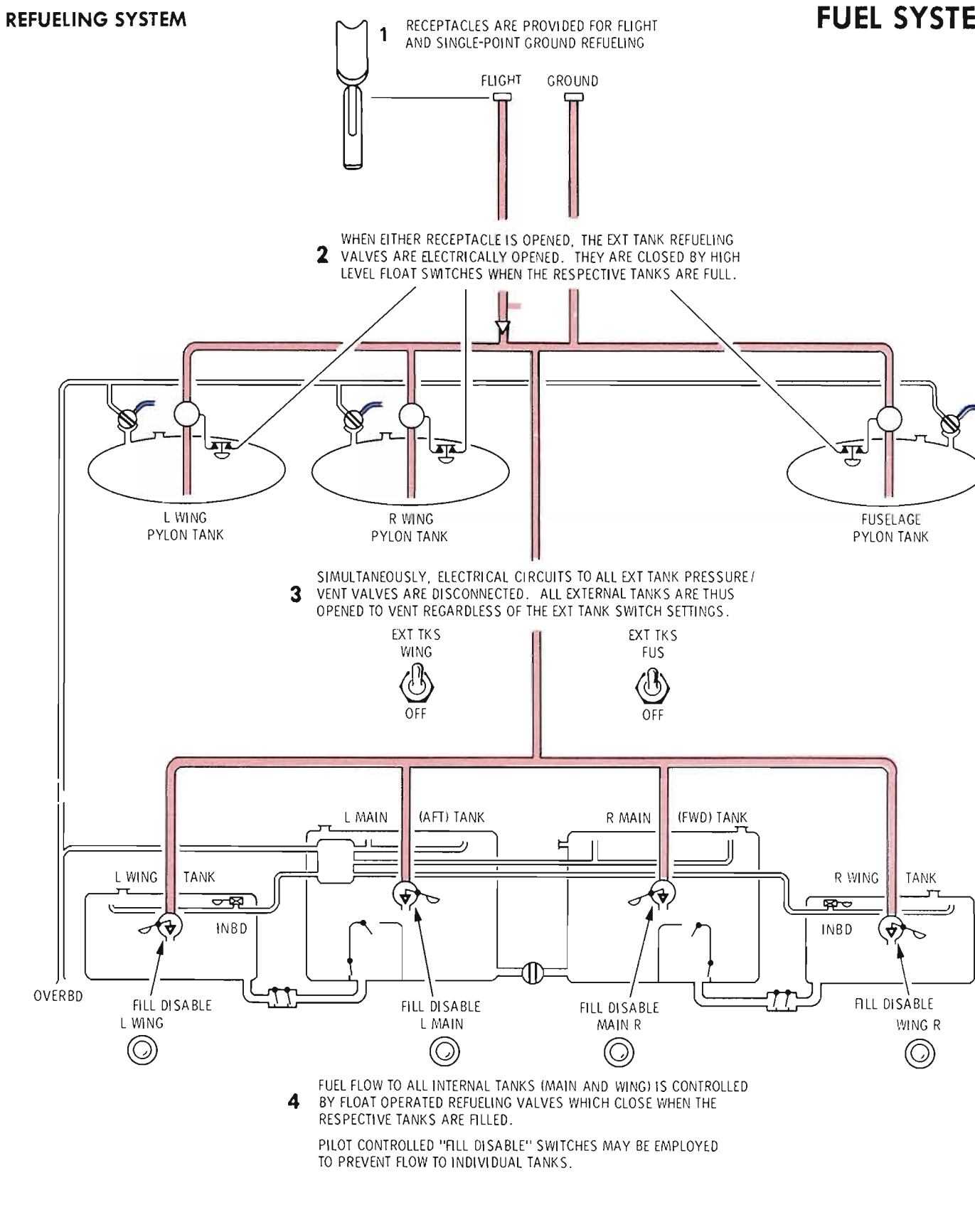

FUEL SYSTEM

Figure FO-4

ELECTRICAL SYSTEM AND POWER DISTRIBUTION

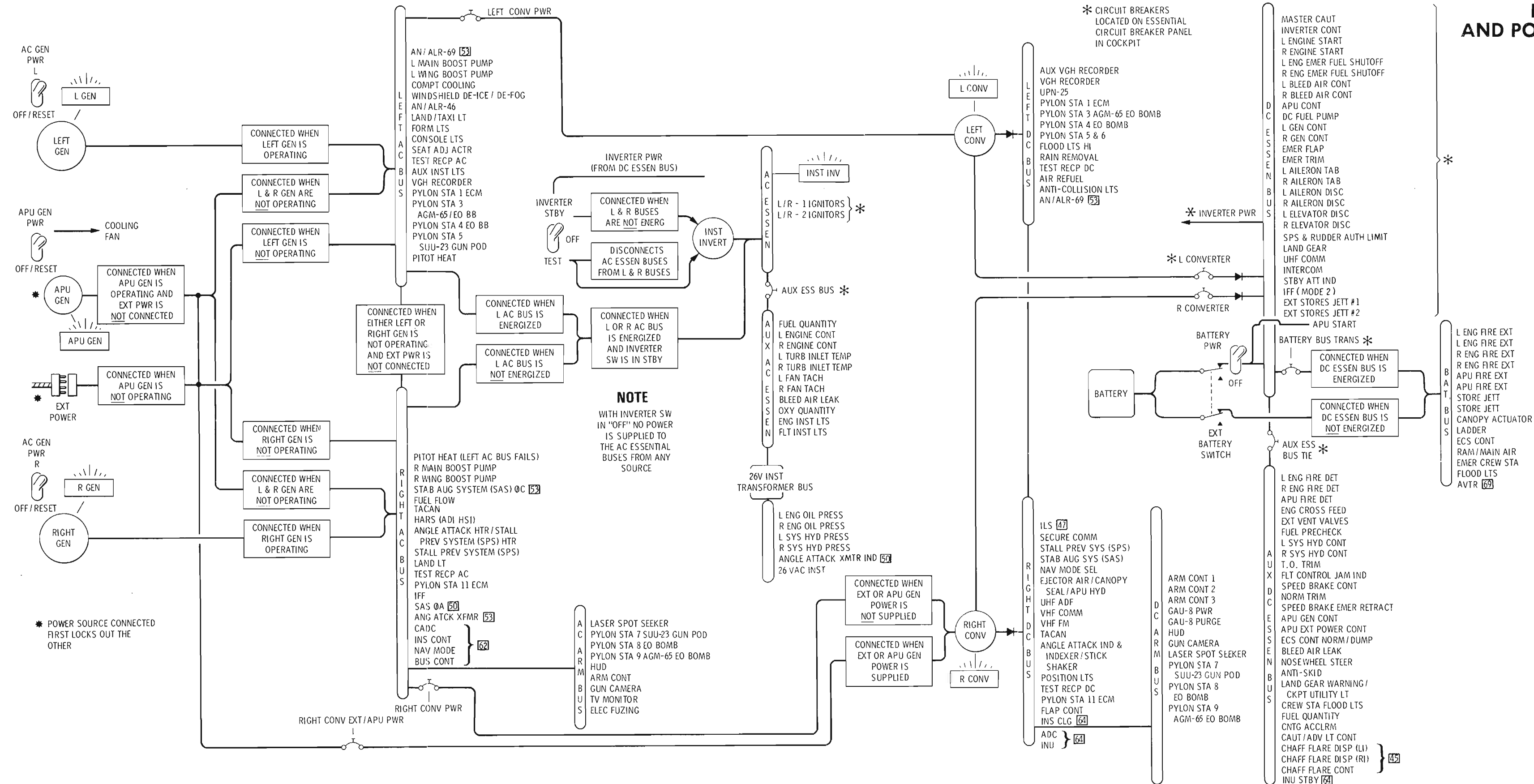

Figure FO-5

HYDRAULIC SYSTEM INSTALLATION

HYDRAULIC POWER SUPPLY

FLIGHT CONTROLS

NON-FLIGHT CONTROLS

HYDRAULIC SYSTEM

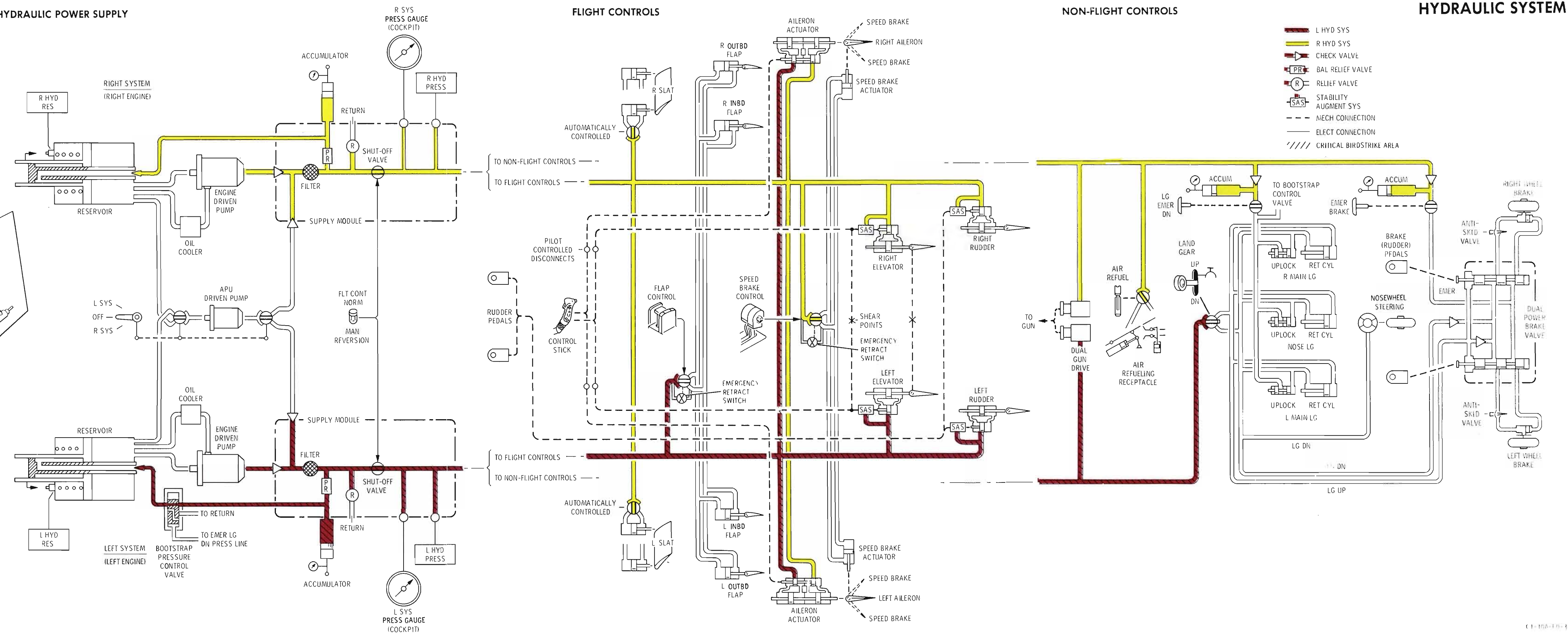
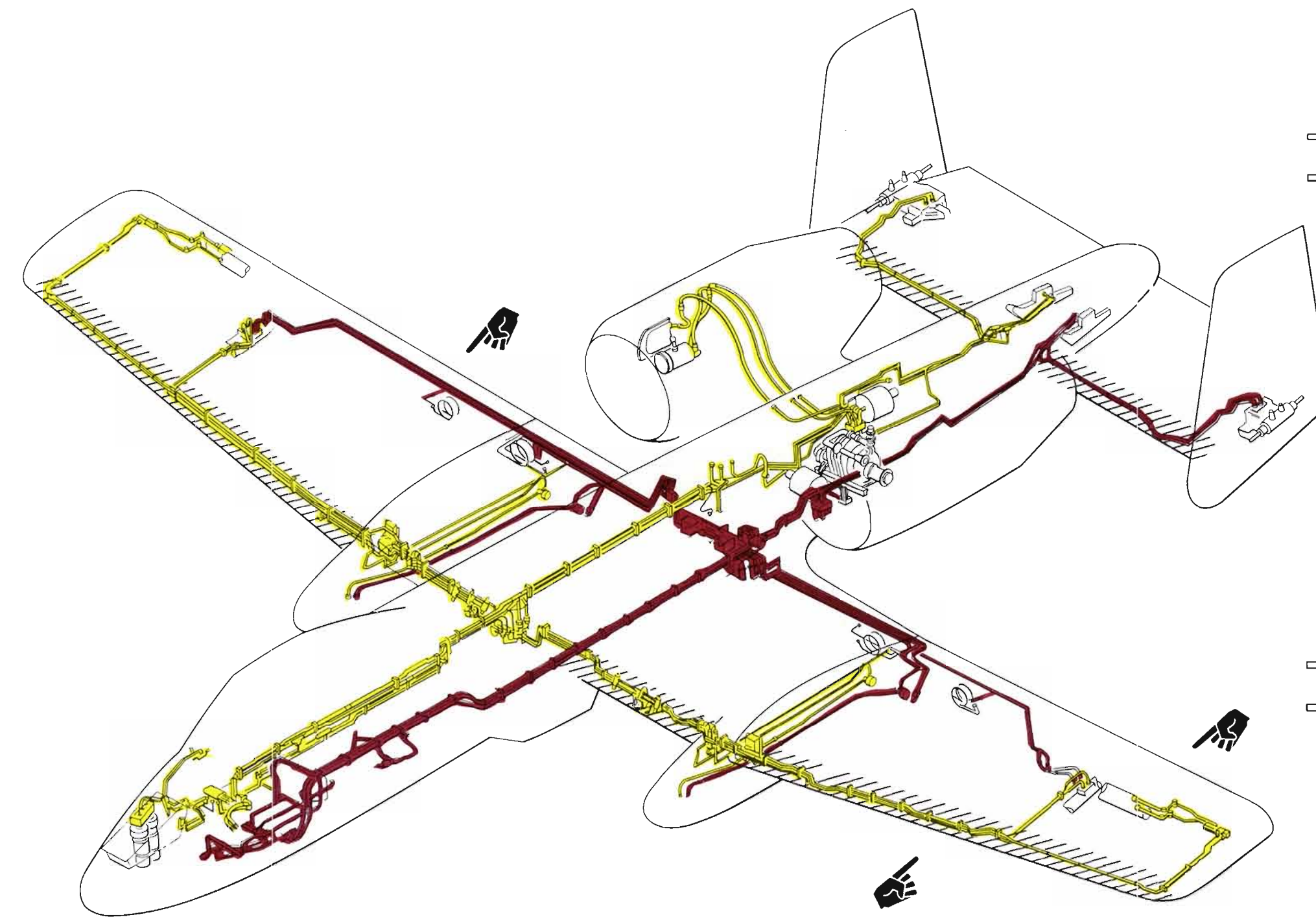

Figure FO-6
Change 4 FO-11/(FO-12 blank)

GLOSSARY

A

ACCEL — Accelerometer
 ACD — Adapter Control Detector
 ADF — Automatic Direction Finder
 ADI — Attitude Director Indicator
 ADL — Armament Data Line
 AGL — Above Ground Level
 AIL — Aileron
 ALT — Altitude
 ANT — Antenna
 AOA — Angle of Attack
 APU — Auxiliary Power Unit
 ARI — Aileron Rudder Interconnect
 A/S — Air Speed
 ATS — Air Turbine Starter
 ATTD — Attitude
 AUX — Auxiliary
 AVTR — Airborne Video Tape Recorder

B

BATH — Best Available True Heading
 BIT — Built-in-Test
 BITE — Built-in-Test Equipment
 BRT — Bright

C

CADC — Central Air Data Computer
 CAS — Calibrated Air Speed
 CCW — Counterclockwise
 CDI — Course Deviation Indicator
 CDU — Control Display Unit
 CEP — Circular Error Probable
 cg — Center of Gravity
 CHAN — Channel
 COMP — Compass
 CONV — Converter
 CORE RPM — Speed of shaft connecting the high
 pressure turbine and the engine compressor
 CRT — Cathode Ray Tube
 CTR — Center
 CTVS — Cockpit Television Sensor
 CW — Clockwise

D

DEPR — Depression
 DISENG — Disengage
 DN — Down

E

ECM — Electronic Countermeasures
 ECS — Environment Control System
 ECU — Environment Control Unit
 EGT — Exhaust Gas Temperature
 ELEV — Elevator
 EMER — Emergency
 ENG — Engine
 EO — Electro-Optical
 ESPS — Engine Stall Prevention System
 EXT — External, Extension

F

FAN RPM — Speed of shaft connecting the low
 pressure turbine and the fan
 FCS — Flight Control System
 FDC — Flight Director Computer
 FLT CONT — Flight Control
 FLT INST — Flight Instrument

G

GCS — Great Circle Steering
 GEN — Generator
 GSI — Glide Slope Indicator

H

HARS — Heading Attitude Reference System
 HDG — Heading
 HI — High
 HM — Hot Mic
 HQ — Have Quick
 HSI — Horizontal Situation Indicator
 HUD — Head-Up-Display
 HYD — Hydraulic

I

IDG — Integrated Drive Generator
 ILS — Instrument Landing System
 IND — Indicator
 INIT — Initialize
 INS — Inertial Navigation System
 INST — Instrument
 INT — Internal
 INU — Inertial Navigation Unit
 INV — Inverter
 ITT — Interstage Turbine Temperature

GLOSSARY (CONT)**K**

KCAS — Knots Calibrated Air Speed
 KHz — Kiloherzt
 KIAS — Knots Indicated Air Speed
 KTAS — Knots True Air Speed

L

LG — Landing Gear
 L/L — Latitude/Longitude
 LO — Low
 LSS — Laser Spot Seeker (Pave Penny)
 LTS — Lights
 LVDT — Linear Variable Differential Transducer

M

MAC — Mean Aerodynamic Chord
 MAN — Manual
 MBC — Master Bus Controller
 MER — Multiple Ejector Rack
 MHz — Megahertz
 MIL — An angular measurement (17.78 mils in 1 degree)
 MRFCS — Manual Reversion Flight Control System
 MVR — Maneuver

O

OFP — Operational Flight Program
 ORIDE — Override

P

PFCS — Primary Flight Control System
 PIO — Pilot Induced Oscillation
 PNL LTS — Panel Lights
 PPOS — Present Position
 PRESS — Pressure
 PRF — Pulse Repetition Frequency
 PSG — Post Stall Gyration
 PT — Pointer
 PWR — Power

R

REC — Receive
 RETR — Retract

S

SAI — Standby Attitude Indicator
 SAS — Stability Augmentation System
 SCS — Selected Course Steering
 SFCS — Secondary Flight Control System
 SFO — Simulated Flameout
 Slant Range — Line-of-sight distance from aircraft to target
 SPD BK — Speed Brake
 SPS — Stall Prevention System
 STBY — Standby
 SYS — System

T

TAS — True Airspeed
 TCN — TACAN
 TEMS — Turbine Engine Monitoring System
 TER — Triple Ejector Rack
 TFAT — Total Free Air Temperature
 TISL — Target Identification Set, Laser
 TK — Tank
 TMN — True Mach Number
 T/O — Takeoff
 TOD — Time of Day
 TSTORM — Thunderstorm
 TVM — TV Monitor
 TVV — Total Velocity Vector

U

UARRSI — Universal Aerial Refueling Receptacle Slipway Installation
 UDU — Umbilical Display Unit
 UTM — Universal Transverse Mercator

V

VAC — Voltage Alternating Current
 VDC — Voltage Direct Current
 VG — Vertical Gyro
 VVI — Vertical Velocity Indicator

W

W/D — Weapon Delivery
 WOD — Word of Day

ALPHABETICAL INDEX

Subject	Page Number	Subject	Page Number
A		A (Cont)	
A-10 External Stores Limitations (Like Stores)	5-24	Alignment Modes	1-113
A-10 External Stores Limitations (Mixed Stores)	5-32	All Gear Up	3-42B
Abort	3-7	Altimeter	1-69
AC Essential Bus, Auxiliary AC Essential Bus, and AC Instrument Transformer Bus	1-21	Altitude Tape	1-158, 1-165
AC System	1-21	AN/ARC-186(V) VHF/AM and VHF/FM Control Panel [57]	1-139
Acceleration Limitations	5-8A	AN/ARC-186(V) VHF/AM and VHF/FM Radios [57]	1-136
Accelerometer	1-74	AN/ARC-186(V) VHF/AM Radio System [57]	1-136
Accelerometer and Compass Lights Switch	1-144	AN/ARC-186(V) VHF/FM Radio System [57]	1-138
Access to Miscellaneous Data	1-118	Angle-of-Attack Indexer	1-73
ADI and HSI Power Off Flags	1-76	Angle-of-Attack Indicator	1-73
Adverse Yaw	6-4	Angle-of-Attack System	1-73
After Landing	2-21	Antenna Locations	1-77
After Refueling	2-25	Antenna Locations/IFF Coding	1-80
After Takeoff and Initial Climb	2-13	Antenna Select Panel	1-122
Aileron/Elevator Control Jams	3-32	Anti-G Garment System	1-67
Aileron Float-Up Transition	1-40	Anti-Skid Caution Light	1-29
Aileron Tab Caution Lights	1-41	Anti-Skid Control System	1-29
Aileron/Tab Shifter Malfunctions	1-41	Anti-Skid Switch	1-29
Aileron/Tab Shifting Transition	1-41	Approach Indexer and Air Refueling Status Lights Control	1-147
Aiming Reticle and Pipper	1-152, 1-165	APU Air or Ground Starting	5-7
Air Conditioner Control Switch	1-64	APU Fire	3-20
Air Refuel Control	1-19	APU Generator Caution Light	1-13
Air Refuel Disconnect/Reset Button	1-19	APU Generator Switch	1-12
Air Refuel Line Check Button	1-20	APU Limitations	5-7
Air Refuel Status Lights	1-20	APU Operation	1-13, 5-7
Air Refueling Exterior and Receptacle Lighting	1-20	APU Fluctuations/Overtemperature/ Overspeed	3-24
Air Refueling Intercommunications	1-20	APU Switch	1-12
Air Refueling Lights	1-143	APU Tachometer	1-13
Air Refueling Lights Switch	1-143	APU Temperature Indicator	1-13
Air Refueling System	1-18A	Armament Control Panel	1-151
Aircraft/Bomb Collision	5-19	Armament Controls	1-148
Aircraft Dimensions	1-3	Armament Ground Safety Override Switch	1-151
Aircraft Fuel System	1-13, FO-7	Armament System	1-150
Aircraft Gross Weight	1-3	Armament System Lights Control	1-147
Airspeed and Altitude Readouts	1-165	Arrangement	ii
Airspeed Indicator	1-70	Artificial Stall Warning	6-6
Airspeed Limitations	5-8	Asymmetrical Load Moment Limitations	5-9
Airspeed Tape	1-165		
Alert/Cocking	2-23		

ALPHABETICAL INDEX (CONT)

Subject	Page Number	Subject	Page Number
A (Cont)		C (Cont)	
Attitude Director Indicator	1-75	CDU Display, ACCEPT/REJECT Page	1-111
Auxiliary Instrument Lights Control	1-144	CDU Display, CALCULATOR Page	1-105
Auxiliary Landing Gear Extension Handle	1-27	CDU Display, DESTINATION Page	1-99
Auxiliary Power Unit	1-12	CDU Display, INERTIAL Page	1-97
B		CDU Display, MISSION Page	1-103
Back-Up Recovery Mode Operation	1-56	CDU Display, POSITION Page	1-94
BATH Alignment (FAST)	1-115	CDU Display, SCRATCH Page	1-107
Battery	1-20	CDU Display, STEER Page	1-101
Battery Bus	1-20	CDU Display, TEST Page	1-108
Battery Failure	3-10	CDU Display, UPDATE Page	1-109
Battery Indicator	1-52	CDU System Status Messages	3-48
Before Ejection	3-25	CDU Test	1-116
Before Exterior Inspection	2-1	Center-of-Gravity	5-9
Before Landing	2-18	Central Air Data Computer [62]	1-67
Before Leaving the Airplane	2-22	Central Air Data Computer and Interfaces [62]	1-68
Before Takeoff	2-13,7-6	Chaff/Flare Dispensing System [45]	1-168
Before Taxiing	2-9,7-4A	Chaff/Flare Dispensing System Release Sequence [45]	5-14
Best Glide — Both Engines Windmilling	3-19	Checklist	2-2
Bleed Air Leak Caution Light	1-7	Checklists	iii
Bleed Air Leak/Service Air Overheat	3-24	Circling Approach	2-18
Bleed Air Switch	1-7	Circuit Breaker Panel	1-22
Bleed Air System	1-5	Clear Function	1-90
Blown Tire	3-42C	Clock	1-75
Boarding Ladder	1-46,1-48	Cockpit Battery Switch	1-20
Brake Limitations	5-5	Cockpit Canopy Control Switch	1-50
C		Cockpit — Loss of Pressurization	3-24A
CADC Caution Light [62]	1-67	Cockpit Overpressurization	3-24A
CADC Test	1-116	Cockpit Overtemperature	3-24A
Calculations	1-119	Cockpit Pressure Altimeter	1-59
Canopy	1-48	Cockpit Television Sensor/Airborne Video Tape Recorder Control Panel [69]	1-168,1-169
Canopy — Loss of	3-24A	Cockpit Utility Light	1-147
Canopy Breaker Tool	1-51	Cold Weather Operation	7-4
Canopy Controls	1-49	Cold Weather Procedure	7-4
Canopy Defog Control	1-66	Communication/Navigation	1-77
Canopy Defog System	1-66	Communications and Navigation Aids	1-78
Canopy Malfunctions	3-5	Conference Capability	1-134
Canopy Unlocked Light	1-50	Console Lights Control	1-146
Canopy Unlocked Light On	3-24A	Control Display Unit	1-90
Canopy/Windshield Crack	3-24A	Control Stick	1-35
Caution Light Analysis	3-43	Controllability Check	3-36
Caution Light Panel	1-145	Controllability/Structural Damage	3-36
CDU Data Entry	1-90	Converter Caution Lights	1-21
		Converter Failure	3-10

ALPHABETICAL INDEX (CONT)

Page Subject	Number	Subject	Page Number
C (Cont)		E (Cont)	
Converters	1-20	Electrical Power System	1-20
Crossfeed Switch	1-18	Electrical System Operation	1-23
Crosswind Landing	2-20	Electronic Countermeasure System	1-168
Crosswind Landing Recommendations	5-5	Elevator/Aileron Disengaged Caution Lights	1-33
Crosswind Takeoff	2-13	Elevator/Aileron Emergency Disengage Switches	1-33
D		Elevator/Aileron Jam Indicator Lights	1-33
Danger Areas	2-7	Emergency Brake Handle	1-28
Data Transfer	1-90	Emergency Brake System	1-28
DC Essential Bus and Auxiliary DC Essential Bus	1-20	Emergency Disconnect Lever	1-29,1-38
DC System	1-20	Emergency Flight Control Panel	1-36
Definition of Words "Shall," "Will," "Should" and "May"	iii	Emergency Floodlights Switch	1-144
Definitions	5-9	Emergency Ground Egress	3-4
Departures	6-6A	Emergency Jettison Button	1-151
Depression Angle Numeric	1-166	Emergency Lever	1-57
Descent/Before Landing	2-14	Emergency Oxygen	1-52
Destination Index (Tadpole)	1-166	Emergency Pitch and Roll Trim Switch	1-36
DG Mode Operation	1-73	Emergency Procedures	3-1
Diluter Lever	1-56	Employment	5-18
Distance To Go	1-166	Engine/APU Fire	3-20
Ditching	3-25	Engine and APU Fire Handles	1-12
Diverter Valves 55	1-66	Engine Core Overtemp/Fuel Fails to Drain/Loss of Pneumatic Power During Engine Start	3-3
Dives/Compressibility Effects	6-4	Engine Core Speed Indicators	1-11
Double Engine Failure	3-18	Engine Fails to Shut Down	3-4
Downlock Solenoid Override Button	1-27	Engine Failures/Overtemp	3-21
Dual Hydraulic System Failure	3-9	Engine Fan Speed Indicators	1-11
During Refueling	2-24	Engine Fire	3-20
E		Engine Fuel Control	1-4
Ejection	3-30	Engine Fuel Flow Indicators	1-5
Ejection Handles	1-52	Engine Fuel Flow Switches	1-5
Ejection Procedures	3-25	Engine Fuel System	1-3
Ejection Seat	1-52	Engine Ignition Controls	1-5
Ejection Seat Operation	3-28	Engine Ignition System	1-5
Ejection System Operating Mode Envelopes	3-29	Engine Ignition System Differences	1-7
Electrical Failure—Total	3-10	Engine Instrument Lights Control	1-144
Electrical Fire—Cockpit	3-13	Engine Interstage Turbine Temperature Indicators	1-11
Electrical Malfunctions	3-10	Engine Limitations	5-7
Electrical Power Control Panel	1-21	Engine Malfunctions	3-18
Electrical Power Supply System Failure Chart	3-11	Engine Oil Pressure Caution Lights	1-3
		Engine Oil Pressure Indicators	1-3
		Engine Oil System	1-3
		Engine Oil System Malfunction	3-22

ALPHABETICAL INDEX (CONT)

Subject	Page Number	Subject	Page Number
E (Cont)		F (Cont)	
Engine Operate Switches 8	1-7	Flap Lever	1-43
Engine Operate Switches 11	1-8	Flap Position Indicator	1-43
Engine Operate Switches 45	1-8	Flaps	6-2
Engine Operation	6-12	Flap System	1-43
Engine Overheat Caution Lights	1-11	Flight	2-14
Engine Shutdown	2-22	Flight Control Effectiveness	6-1
Engine Start Cycle Caution Light	1-11	Flight Control Mode Switch	1-40
Engine Start Cycle Continues After Start	3-4	Flight Instruments	1-67
Engine Start Cycle Light On	3-22A	Flight Instruments Light Control	1-144
Engine Start System	1-8,1-10	Flight Manual Binders	iii
Engine Start System Differences	1-9	Flight Path Ladder and Roll Bars	1-165
Engine Starting Limitations	5-7	Flight Path/Pitch Angle Numeric	1-165
Engine/APU Fire	3-3,3-23	Flight Planning	2-1
Engines	1-3	Flight Restrictions	2-1,5-5
Environment Control Panel	1-64	Flight Strength Diagram	5-10
Environment System	1-58	Floodlights Control	1-144
Environment System Schematic	1-61	Flow Level Control	1-65
Error Checking	1-90	FM Homing ADI Display	1-140
Exterior Inspection	2-1,2-2,7-4,7-5	FM Homing Capability	1-136
Exterior Lights	1-141	FM Homing Capability (VHF/FM Radio Only)	1-140
External Battery Switch	1-20	Formation Lights	1-142
External Canopy Actuator Disengage Controls	1-51	Formation Lights Switch	1-143
External Canopy Control Switch	1-51	Fuel Imbalance	5-5
External Canopy Jettison Controls	1-52	Fuel Pressure Low	3-15
External Canopy Opening Assist Handles	1-52	Fuel Quantity Indicator and Selector	1-14,1-16
External Power	1-23	Fuel Quantity Indicator Malfunction	3-15
External Stores Limitations	5-9	Fuel System Control Panel	1-17
External Tank Jettison	3-15	Fuel System Operation	1-18
External Tank Switches	1-18	Fuel Systems Malfunctions	3-15
		Fuel Tank Vent System	1-16
F		G	
Failure Mode Flight Characteristics	6-12	General	3-24
Failure to Shift Into Manual Reversion	3-33	General Arrangement Diagram	1-2
Failure to Shift Out of Manual Reversion	3-33	General Flight Characteristics	6-1
Fast Alignment	1-113	General Notes Relating to External Store Limitation Charts	5-22
Fill Disable Switches	1-19	General Restrictions	5-1
Fire Detect/Bleed Air Leak Test Button	1-7	General Restrictions and Definitions	5-16
Fire Detection System	1-11	General Rules for Error Checking	1-113
Fire Extinguishing Agent Discharge Switch	1-12	Generator Caution Lights	1-23
Fire Extinguishing System	1-11	Generator Failure	3-14
Flameout Landing Pattern	3-31	Generator Switches	1-23
Flameout Landing	3-30		
Flap Asymmetry	3-32,6-13		
Flap Emergency Retract Switch	1-43		

ALPHABETICAL INDEX (CONT)

Subject	Page Number	Subject	Page Number
G (Cont)		I (Cont)	
Generators	1-23	Identification System — IFF (AN/APX-101)	1-121
Geographical Data Entry	1-113	IFF Antenna Switch	1-121
Glossary	Glossary 1	IFF Operation	1-122
Ground Operation Emergencies	3-3	IFF/SIF Control Panel	1-123
Guard Operation	1-134	ILS ADI/HSI Display	1-87
Gun Cross	1-152,1-165	ILS Approach	2-14
Gun Ready Light	1-150A	ILS Control Panel 47	1-88
Gun Unsafe Light	1-151	ILS Operation	1-95
Gunsight Camera System 68	1-168	Index to External Stores Limitation Charts (Like Store Loads)	5-20
H		Indicated Airspeed Tape	1-152
HARS Caution Light 64	1-70	Inertia Reel Power Haul-Back	1-52
HARS Fast Erect/INS Mark/Update Switches	1-72	Inertial Navigation Caution Light	1-89
HARS Fast Erect Switch	1-70	Inertial Navigation System 62	1-87
HARS Malfunction 64 78	3-35	Inertial Navigation Unit	1-89
HARS/SAS Override Switch 78 79	1-39	Inflight Emergencies	3-9
Have Quick UHF System (Jam-Resistant)	1-133	Inflight Stall Speeds	6-7
Head-Up Display System	1-152	INS Failure 62	3-35
Heading Attitude Reference System	1-70	INS Operations	1-113
Heading Attitude Reference System Control Panel	1-71	INS Steering Modes	1-89
Horizontal Situation Indicator	1-76	Instrument Approaches	2-14
Hot Refueling	2-24	Instrument Inverter	1-21
Hot Weather and Desert Operation	7-5	Instrument Inverter Caution Light	1-23
How to be Assured of Having Latest Data	ii	Instrument Inverter Switch	1-23
How to Get Personal Copies	iii	Instrument Landing System 47	1-86
HUD Control Panel	1-152	Instrument Markings	5-1,5-2
HUD Display Symbology 61	1-152	Instrument Meteorological Conditions	5-5
HUD Display Symbology 62	1-165	Integrated Drive Generators	1-23
HUD System Displays 61	1-157	Intercom Control Panel	1-128
HUD System Displays 62	1-159	Intercom System	1-127
HUD System Operation	1-166	Interior Inspection	2-3,7-6
Hydraulic Power Supply System	1-24	Interior Lighting	1-143
Hydraulic Pressure Caution Lights	1-24	Internal Canopy Actuator Disengage Lever	1-51
Hydraulic Reservoir Low Level Caution Lights	1-24	Internal Canopy Jettison Handle	1-51
Hydraulic Systems Malfunctions	3-9	Internal Emergency Canopy Actuator Release Lever	1-51
Hydraulic Systems Pressure Gauges	1-24	Internal Manual Canopy Opening Assist Handles	1-51
Hydroplaning	7-2	Introduction	3-2A,7-1
Hypoxia	3-17	INU Air Hot Caution Light 62	1-59
I		Inverter Failure (No Power Available to AC Essential Busses)	3-14
Ice and Rain	7-2	ITT Control System Failure/Low Core RPM at MAX Power	3-22A

ALPHABETICAL INDEX

Subject	Page Number	Subject	Page Number
J		L (Cont)	
Jam-Resistant (Active) Mode Operation	1-134	Loss of Mechanical Command Paths to Rudders	6-13
Jettisoning	5-18	Loss of One Pitch Mechanical Command Path	6-12
L		M	
L-R Tanks Unequal	3-15	Magnetic Heading Tape	1-166
Landing	2-18,7-5,7-6	Main Air Supply Switch	1-59
Landing and Taxi Lights	1-141	Main Boost Pump Failure	3-16
Landing Emergencies	3-37	Main Landing Gear	1-25
Landing Gear Alternate Extension	3-42	Main Tank Boost Pump Switches	1-17
Landing Gear Handle	1-25	Maneuvering Flight Characteristics	6-3
Landing Gear Horn Silence Button	1-28	Manual Inertia Reel Control	1-52
Landing Gear Position Indicating and Warning System	1-27	Manual Reversion Flight Characteristics	6-5
Landing Gear Retraction Failure	3-8A	Manual Reversion Flight Control System	1-40
Landing Gear System	1-25	Manual Reversion Landing	3-41
Landing Gear System Schematic	1-26	Manual Reversion Single-Engine Flight Characteristics	6-11
Landing in Gusts	2-18	Manual Reversion Spin Recovery	6-10
Landing/Taxi Lights Switch	1-141	Mark Function	1-117
Landing With Gear Not Down	3-42B	Master Bus Controller 62	1-90
Left AC Bus, Right AC Bus, and AC Armament Bus	1-23	Master Caution and Caution Panel Lights	1-147
Left and Right Fuel Pressure Caution Lights	1-16	Master Exterior Light/Missile Video Polarity Switch	1-141
Left and Right Main Boost Pump Caution Lights	1-17	Maximum Dive for Employment	5-18
Left and Right Main Fuel Low Caution Lights	1-16	MBC Test	1-116
Left and Right Tanks Unequal Caution Light	1-18	MIC Switch	1-127
Left and Right Wing Boost Pump Caution Lights	1-17	Minimum Ejection Altitude vs Airspeed and Dive Angle	3-27
Left DC Bus, Right DC Bus, and DC Armament Bus	1-21	Minimum Ejection Altitude vs Sink Rate	3-26
Left/Right Hydraulic System Failure	3-9	Minimum Release Interval	5-18
Letters and Numbers	1-90	Minimum Run Landing	2-18
Level Flight Characteristics	6-2A	Missed Approach	2-21
Lighting Control Panel	1-142	Mixed Store Partial Configurations (Normal Release Sequence)	5-16
Lighting System	1-141	Mode 4 Caution Light	1-121
Like Store Partial Configurations	5-15	Monitor Circuit Test Switch	1-38
Lineup Check	2-13	MRFCS Operation	1-41
Loss of All Mechanical Command Paths and Hydraulics on One Side	6-13	N	
		Nacelle Floodlight 21	1-143
		Nacelle Floodlight Control 21	1-143

ALPHABETICAL INDEX (CONT)

Subject	Page Number	Subject	Page Number
N (Cont)		P	
Navigation Interface Chart 61	1-83	Permissible Operations	ii
Navigation Interface Chart 62	1-84	Pitch and Roll Trim Control Systems	1-35
Navigation Mode Select Panel	1-77, 1-81	Pitch and Roll Trim Switch	1-36
Net Number	1-133	Pitch Angle	1-158
Night Flying	7-3	Pitch Control	6-2
Normal Alignment	1-113	Pitch Control System	1-30
Normal Alignment/Cocking Procedure	1-114	Pitch Control System Schematic	1-31
Normal Brake/Anti-Skid Failure	3-5	Pitch MRFCS	1-40
Normal Procedures	2-1	Pitch/Roll Trim Override Switch	1-36
Nose Floodlights 21	1-143	Pitch SAS	1-38
Nose Floodlights Switch 21	1-143	Pitch SAS Caution Light	1-38
Nose Gear Safe, and One Main Gear Safe	3-42B	Pitch SAS Engage Switches	1-38
Nose Gear Safe, Both Mains Unsafe	3-42B	Pitch/Yaw SAS Disengagement	3-34
Nose Gear Unsafe, One or Both Mains Safe	3-42B	Pitot Heater Switch	1-67
Nose Landing Gear	1-25	Pitot-Static System	1-67
Nosewheel Cocked	3-42C	Position Flyover Update	1-118
Nosewheel Steering Button	1-28	Position Lights	1-142
Nosewheel Steering Engaged Advisory Light	1-28	Position Lights Switch	1-142
Nosewheel Steering Malfunction	3-5	Post-Stall Gyration	6-9
Nosewheel Steering System	1-28	Preparation for Flight	2-1
O		Primary Flight Control System	1-29
Offset Point Computations	1-117	Prior to Engine Start	2-6, 7-4A
Operating Limitations	5-1	Prior to Hot Pit Entry	2-24
Operation of the KY-28 or KY-58 System	1-140	Prior to Landing	3-33
Operational Supplements	iii	Prior to Refueling	2-24
Out-of-Control Characteristics	6-6A	Prohibited and Restricted Maneuvers	5-8
Out-of-Control Recovery	3-34	R	
Out-of-Control Recovery Characteristics	6-10	Radar Approach	2-14
Oxygen	3-17	Radar Beacon Control Switch	1-127
Oxygen Flow Indicator	1-57	Radar Warning Systems	1-170
Oxygen Indicator Test Button	1-58	Radio Locator Beacon	1-54
Oxygen Low-Level Caution Light	1-58	Rain Removal/Windshield Wash Switch	1-66
Oxygen Quantity Indicator	1-58	Restraint Emergency Release Handle	1-54
Oxygen Regulator	1-56	Reticule Eyebrows	1-166
Oxygen Supply Pressure Indicator	1-57	Roll Accelerations	6-9
Oxygen System	1-56	Roll Attitude	1-158
Oxygen System Regulator and Quantity Gauge	1-58	Roll Bars (HARS Only)	1-166
		Roll Control	6-1
		Roll Control System	1-30
		Roll Control System Schematic	1-32

ALPHABETICAL INDEX (CONT)

Subject	Page Number	Subject	Page Number
R (Cont)		S (Cont)	
Roll MRFCS	1-40	Speed Brake Asymmetry or Fail to Close	3-32
Roll Reversals	6-9	Speed Brake Emergency Retract Switch	1-46
Rudder Pedal Adjustment Handle	1-35	Speed Brake Switch	1-46
Runaway Trim	6-13	Speed Brake System	1-46
S		Speed Brake System Schematic	1-47
Safety Supplements	ii	Speed Brakes	6-2A
Scope	ii	Spins	6-9
Scramble (Before Takeoff)	2-23	Stability Augmentation System	1-37
Scramble (Before Taxiing)	2-23	Stability Augmentation System Panel	1-37
Seat	1-53	Stall/Departure/Spin Avoidance	6-9
Seat Adjustment Switch	1-52A	Stall Recovery	6-6A
Seat Ground Safety Lever	1-52	Stall System Caution Light	1-74
Seat Operation-Ejection Sequence	1-54	Stall Warning and Engine/Airframe Compatibility	6-8
Secondary Flight Control System	1-43	Stall Warning Control Panel	1-74
Secure Voice Communications System	1-140	Stall Warning System	1-73
Service Air Hot Caution Light	1-59	Stalls	6-6
Servicing Diagram	1-171	Stalls with Asymmetric Stores	6-6
Shifting Back to PFCS Mode	1-42	Standby Attitude Indicator	1-77
Shifting to MRFCS Mode (Hydraulic Power Available)	1-41	Standby Compass	1-77
Shifting to MRFCS Mode (Hydraulic Power Not Available)	1-42	Standby Flight Instruments	1-77
Sideslip Departures	6-9	Standby Reticle	1-152,1-165
Signal Amplifier Switch	1-19	Starting Engines	2-6,7-4A
Signal Lights Switch	1-146	Steerpoint Alphanumeric Readout	1-166
Signal Lights Test Button	1-146	Stick Throw	5-18
Single Operable Aileron	6-12	Store Nomenclature	5-50
Single Operable Elevator	6-12	Stored Heading Alignment (FAST)	1-115
Single-Engine Failure or Fire During Takeoff (Too Late to Abort)	3-7	Stores Carriage	5-17
Single-Engine Failure or Fire While Configured for Landing	3-37	Stores Carriage Capability	1-150
Single-Engine Flight Characteristics	6-10	Straight-in-Approach	2-18
Single-Engine Go-Around	3-41	Strobe Anti-Collision Lights	1-142
Single-Engine Landing	3-39	Strobe Anti-Collision Lights Switch	1-142
Single-Engine Restart	3-22A	Stuck Throttle(s) Landing	3-39
Single-Engine Stalls	6-6	Supply Lever	1-56
Sink Rate Limitations	5-9	Survival Kit	1-54,1-55
Slat System	1-43	Survival Kit Deployment Selector	1-54
Slaved Mode Operation	1-70	Symbols Used in Stores Limitations Charts	5-13
Smoke, Fumes, or Odors	3-17	T	
Specific Notes Referenced from External Store Limitation Charts	5-23	TACAN (AN/ARN-118 (V))	1-77
		TACAN Antennas	1-77
		TACAN Approach	2-14

ALPHABETICAL INDEX (CONT)

Subject	Page Number	Page Subject	Number
T (Cont)		T (Cont)	
TACAN Control Panel-AN/ARN-118(V)	1-85	Typical Overhead Landing Pattern	2-19
TACAN Controls	1-77	Typical Radar Approach—GCA	2-17
TACAN-HSI Display	1-77		
TACAN Modes of Operation	1-79	U	
TACAN Operation	1-79		
TACAN Penetration and Approach—Typical	2-15	UHF Antenna Select Switch	1-130
Takeoff	2-13,7-5,7-6	UHF Automatic Direction Finding	1-127
Takeoff Emergencies	3-7	UHF Radio Controls	1-131
Takeoff Trim Button	1-37	UHF Radio System	1-127
Takeoff Trim Control System	1-37	UHF Radio Antenna System	1-127
Takeoff Trim Light	1-37	UHF Radio Operation (Normal Mode)	1-130
Tank Gate Switch	1-18	UHF Remote Frequency/Channel Indicator	1-134
Target Identification Set Laser	1-168	Uncommanded Pitch/Yaw Input	3-35
Taxi	2-11,7-5	Unsafe Gear Down Indication	3-42
Temperature Level Control	1-65	Unsuccessful APU Starts	5-7
Temperature/Pressure Control Position Versus Main Air Supply Switch Position	1-65	Usable Fuel Quantity Data	1-15
Temperature/Pressure Control Switch	1-59		
Terminal Error Update	1-118	V	
Test Mode	1-167	VHF/AM and VHF/FM Common Radio Operations 57	1-138
TF-34 Engine	1-4	VHF/AM and VHF/FM Radio Control Panels	1-138
The Aircraft	1-1	VHF/AM Control Panel 56	1-135
Throttle Friction Control	1-5	VHF/AM Radio System 56	1-134
Throttle Quadrant Including Engine Control Panel	1-6	VHF/FM Control Panel	1-136
Throttles	1-5	VHF/FM Radio Operation	1-136
Time To Go	1-174	VHF/FM Radio System 56	1-136
Time-of-Day Reception	1-133	Vertical Gyro Operation	1-73
Time-of-Day Transmission	1-133	Vertical Velocity Indicator	1-70
Tire Failure During Takeoff	3-8A		
TISL Diamond and Line	1-158,1-165	W	
Total Drag Index	5-19	Warnings, Cautions and Notes	iii
Total Velocity Vector	1-166	Weapon Station Select Switches	1-151
Touch and Go	2-21	Weapon Station Select Switches Dimmer Control	1-151
Trigger Switch	1-152	Weapons Release Button	1-152
Trim Failure	3-35	Weight and Balance	2-1
Turbulence and Thunderstorms	7-1	Weight Limitations	5-9
Turning Radius and Ground Clearance	2-12		
TV Monitor System	1-168		
Typical ILS Approach 47	2-16		

ALPHABETICAL INDEX (CONT)

Subject	Page Number	Subject	Page Number
W (Cont)		X	
Wheel Brake Energy Limits (One Continuous Brake Application)	5-6	X-Band Radar Beacon System	1-126
Wheel Brake System	1-28	Y	
Windmill Airstart	3-22B	Yaw Control	6-2
Windmill Start Envelope	3-21	Yaw Control System	1-33
Windshield Defog/Deice Switch	1-66	Yaw Control System Schematic	1-34
Windshield Defog/Deice System	1-66	Yaw MRFCs	1-40
Windshield Hot Caution Light	1-66	Yaw SAS	1-38
Windshield Rain Removal System	1-66	Yaw SAS Caution Light	1-40
Windshield Wash System 19	1-66	Yaw SAS Engage Switches	1-39
Wing Boost Pump Failure	3-17	Yaw Trim Control Knob	1-37
Wing Flap System Schematic	1-44	Your Responsibility—to Let Us Know	iii
Wing Slat System Schematic	1-45		
Wing Tank Boost Pump Switches	1-17	30MM Gun System	1-150
WOD Transfer to Volatile Memory	1-133		
Word-of-Day Entry	1-133		

Supplement

FLIGHT MANUAL

USAF SERIES
A/OA-10A AIRCRAFT

TODO *7cc 6d* 10 DEC 1987

Serno 73-01665 and subsequent
FAIRCHILD REPUBLIC COMPANY
F33657-73-C-0500
F33657-79-C-0502

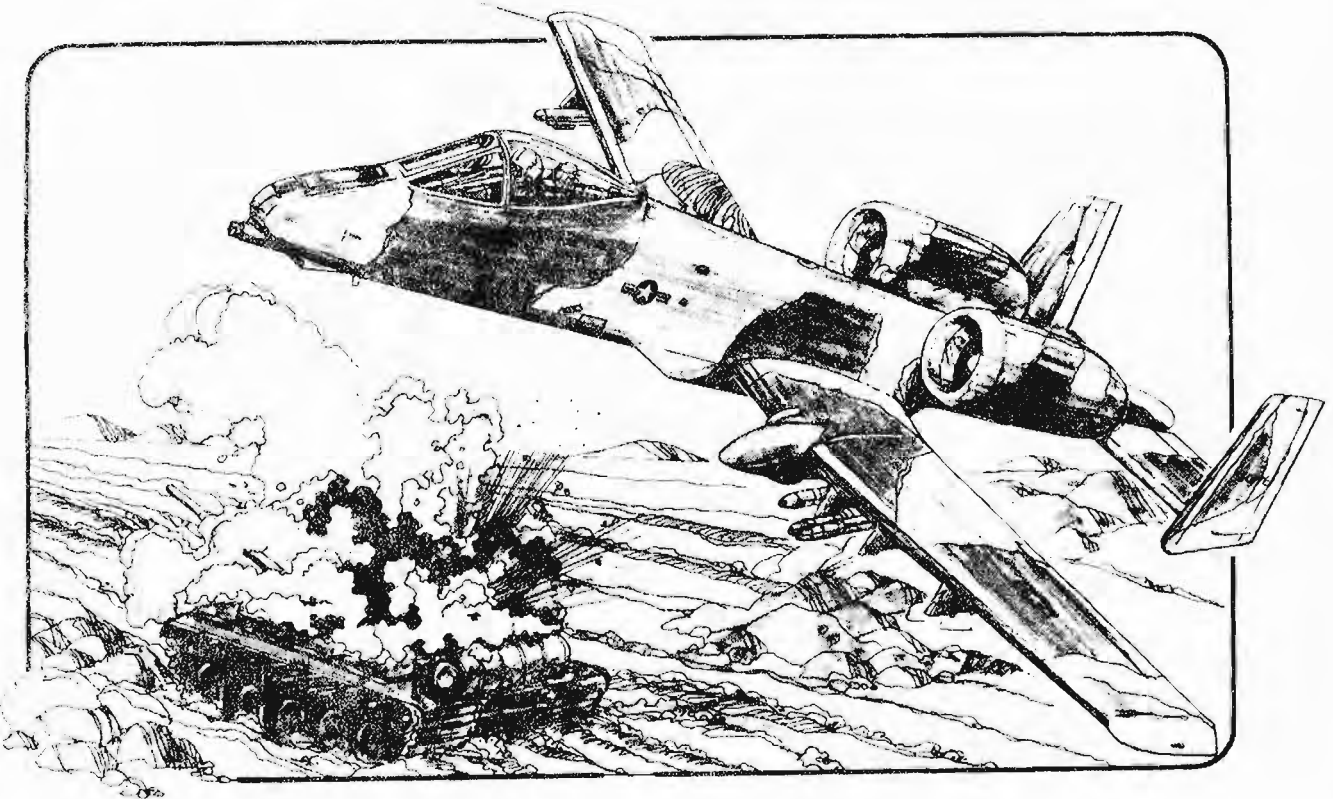

This manual supplements TO 1A-10A-1

DISTRIBUTION STATEMENT - Distribution authorized to U.S. Government agencies only for administrative or operational use (16 September 1987). Other requests for this document shall be referred to Sacramento ALC/MMEDTD, McClellan AFB, CA 95652-5609.
HANDLING AND DESTRUCTION NOTICE - Handle in compliance with distribution statement and destroy by any method that will prevent disclosure of the contents or reconstruction of the document.

Commanders are responsible for bringing this publication to the attention of all Air Force personnel cleared for operation of subject aircraft.

Published under Authority of the Secretary of the Air Force

30 NOVEMBER 1982

CHANGE 5 - 16 SEPTEMBER 1987

LIST OF EFFECTIVE PAGES

NOTE: The portion of the text affected by the changes is indicated by a vertical line in the outer margins of the page. Changes to illustrations are indicated by miniature pointing hands. Changes to wiring diagrams are indicated by shaded areas.

Dates of issue for original and changed pages are:

Original.....0..... 30 Nov 82 Change.....3..... 10 Jul 86
 Change.....1..... 15 Apr 85 Change.....4..... 27 Apr 87
 Change.....2..... 25 Sep 85 Change.....5..... 16 Sep 87

TOTAL NUMBER OF PAGES IN THIS PUBLICATION IS 166, CONSISTING OF THE FOLLOWING:

Page No.	*Change No.	Page No.	*Change No.	Page No.	*Change No.
Title	5	A3-11	5		
A	5	A3-12	2		
A-1	0	A3-13	4		
A-2 Blank	0	A3-14	2		
A1-1	0	A3-15	4		
A1-2	2	A3-16 - A3-19	2		
A1-2A	1	A3-20 Blank	2		
A1-2B Blank	1	A4-1 - A4-6	0		
A1-3 - A1-9	0	A4-7	1		
A1-10	1	A4-8 - A4-20	2		
A1-11 - A1-14	2	A4-21 - A4-23	0		
A1-15 - A1-16	0	A4-24 Blank	0		
A1-17 - A1-18	2	A5-1 - A5-4	0		
A2-1	5	A5-5 - A5-9	2		
A2-2	5	A5-10 Blank	2		
A2-3	0	A6-1 - A6-2	5		
A2-4 - A2-9	5	A6-3 - A6-7	0		
A2-10 - A2-11	0	A6-8	2		
A2-12	5	A6-9	5		
A2-13	0	A6-10	2		
A2-14	1	A6-11	4		
A2-14A - A2-14B Added	4	A6-12	5		
A2-15 - A2-16	0	A6-13 - A6-18	2		
A2-17 - A2-18	4	A7-1 - A7-4	0		
A2-19	5	A7-5 - A7-9	2		
A2-20 - A2-23	4	A7-10 Blank	2		
A2-24	2	A8-1 - A8-4	0		
A2-25 - A2-28	4	A8-5	3		
A2-28A Added	4	A8-6 - A8-9	2		
A2-28B Added	4	A8-10 Blank	2		
A2-29	3	A9-1	5		
A2-30	2	A9-2 - A9-17	0		
A2-31	5	A9-18 Blank	0		
A2-32	4				
A2-33 - A2-37 Added	4				
A2-38 Blank Added	4				
A3-1	5				
A3-2 - A3-3	0				
A3-4	5				
A3-5 - A3-7	0				
A3-8 - A3-9	2				
A3-10	4				

*Zero in this column indicates an original page

APPENDIX I
PERFORMANCE DATA

TABLE OF CONTENTS

PART I	INTRODUCTION	A1-1
PART II	TAKEOFF	A2-1
PART III	CLIMB	A3-1
PART IV	RANGE	A4-1
PART V	ENDURANCE	A5-1
PART VI	COMBAT	A6-1
PART VII	DESCENT	A7-1
PART VIII	LANDING	A8-1
PART IX	MISSION PLANNING	A9-1

PART I

INTRODUCTION

TABLE OF CONTENTS

	<u>Page</u>
Introduction	A1-1
Performance Data Basis	A1-1
Drag Index System	A1-2
Drag Index and Weight Data Chart	A1-2
Drag Due to Weight Asymmetry	A1-3
Altitude and Airspeed Installation Error Correction	A1-3
Altimeter Lag Correction	A1-3
Airspeed Conversion	A1-4
Standard Atmosphere Table	A1-5
Temperature Conversion	A1-5
Fuel Density	A1-5
Stall Speeds	A1-6

LIST OF CHARTS

<u>Figure</u>	<u>Page</u>
A1-1 A-10A Stores Drag	A1-7
A1-2 Drag Due to Weight Asymmetry	A1-11
A1-3 Altitude and Airspeed Installation Error Correction	A1-12
A1-4 Altimeter Lag Correction	A1-13
A1-5 Airspeed Conversion	A1-14
A1-6 Standard Atmosphere Table	A1-15
A1-7 Temperature Conversion Chart	A1-16
A1-8 Fuel Density	A1-17
A1-9 Stall Speeds	A1-18

INTRODUCTION

This appendix contains the performance data required for accurate preflight planning of missions. This data is divided into parts I through VIII in proper sequence for mission planning. Part IX details the mission planning process. Descriptive text in each part discusses and explains the use of the charts provided in that part. Because of the large number of stores and stores loading combinations the aircraft is capable of carrying, most charts are presented in a drag index format.

PERFORMANCE DATA BASIS

Flight performance information is based on Air Force conducted flight tests. Charts are presented for U.S. standard atmospheric conditions, although ambient temperature correction scales are provided where temperature effects are significant. The temperature correction scale is shown on some charts as actual ambient temperature. On other charts, the temperature correction is shown as an incremental change applied to the standard day temperature at all altitudes, that is, standard plus

20°C. The charts may be used in conjunction with all fuels (JP-4, JP-5, JP-8, etc.). A fuel density chart is provided to be used for fuel weight computations.

Each nontabular chart contains a miniature reproduction of the chart in the upper part of the title block with "chase around" guide-lines for reference to chart entry.

NOTE

- On aircraft modified by T.O. 1A-10-1154, the TF34-GE-100A engine increased ITT operating limits are only intended to allow trim adjustments as necessary to maintain predicted normal rated thrust.
- All performance data in this manual for TF34-GE-100 engines is also applicable to TF34-GE-100A engines.

DRAG INDEX SYSTEM

The drag index system permits the presentation of performance data for a large number of external store loadings on one chart, and thereby greatly reduces the number of charts required in flight planning work. In the drag index system, each item of the external store configuration, such as a bomb or pylon, is assigned a drag index whose value depends on the size and shape of the item and its location on the aircraft. The summation of the store drag indexes for a particular loading define a drag index for that configuration. This drag index, when used in the performance charts, determines the aircraft performance for that external store configuration. The baseline aircraft configuration (drag index = 0) is 11 pylons, Pave Penny pylon and pod, with leading edge slats retracted and chaff/flare with cover plates installed.

On all charts, drag index = 0 (baseline) includes all drag associated with conditions, when specified in title block.

NOTE

On aircraft modified by T.O. 1A-10-1059, add a drag index of 0.38 to the aircraft drag.

DRAG INDEX AND WEIGHT DATA CHART

The drag index and gross weight of specific suspension equipment items are given on the upper portion of figure A1-1, sheet 1. Drag indexes and gross weights for the various approved stores are presented on the lower portion of figure A1-1, sheet 1, sheet 2, and the upper portion of sheet 3.

Eleven store stations are available on the aircraft with station 1 being the outboard station on the left wing. Stations are numbered consecutively, left-to-right, to station 11, the outboard station on the right wing. The fuselage centerline station is station 6.

Drag index values for various configuration changes, such as landing gear extended, flaps extended, pylons removed, etc. are presented on the bottom portion of figure A1-1, sheets 3 and 4.

DIRECTIONS FOR USE OF CHART

An example of the use of figure A1-1 to determine the drag indexes and the external store weights is shown below:

Given:

- Six pylons at stations 1, 3, 5 and 7, 9, 11
- Six AGM-65A missiles on two LAU-88/A launchers
- AN/ALQ-119(V) -10 ECM pod
- Full load of flares with no cover plates

Calculate:

A. Drag index and total external store load weight

<u>Items</u>	<u>Gross Weight ~ Lb</u>	<u>Drag Index</u>
A. Offload pylons at stations 2, 4, 6, 8, and 10	-593	$5 \times -0.38 = -1.90$
B. Six AGM-65A missiles	$6 \times 464 = 2,784$	$6 \times 0.35 = 2.10$
Two LAU-88/A launchers	$2 \times 465 = 930$	$2 \times 0.61 = 1.22$
C. AN/ALQ-119(V) -10	576	0.91
D. Full load of flares, no cover plates installed	328	0.05
	Total external stores weight = 4,025 lb	Total drag index = 2.38

DRAG DUE TO WEIGHT ASYMMETRY

For configurations consisting of external stores that result in a weight asymmetry, an additional drag index must be determined for the additional drag due to the deflection of the ailerons required for trim. Figure A1-2 presents a chart from which this additional drag index may be determined for any given flight condition.

DIRECTIONS FOR USE OF CHART

Enter the chart with the pylon stations at which the asymmetric loading exists and proceed vertically up to the net weight asymmetry (difference between the weight at the left station and the weight at the right station). Interpolation may be necessary. From this point, proceed horizontally to the right to the true Mach number, then down to the pressure altitude, and finally proceed to the left to read the incremental drag index due to a weight asymmetry.

Sample Problem

Given:

- A. AN/ALQ-119(V) -10 ECM pod (576 lb) located on pylon station 1 and an empty pylon at station 11
- B. True Mach no. = 0.30
- C. Pressure altitude = 15,000 ft

Calculate:

A. Incremental drag index due to weight asymmetry

B. Use drag due to weight asymmetry chart, figure A1-2

- | | |
|------------------------------------|-----------|
| 1. Pylon stations | 1 or 11 |
| 2. Net asymmetric weight (576 - 0) | 576 lb |
| 3. True Mach no. | 0.3 |
| 4. Pressure altitude | 15,000 ft |

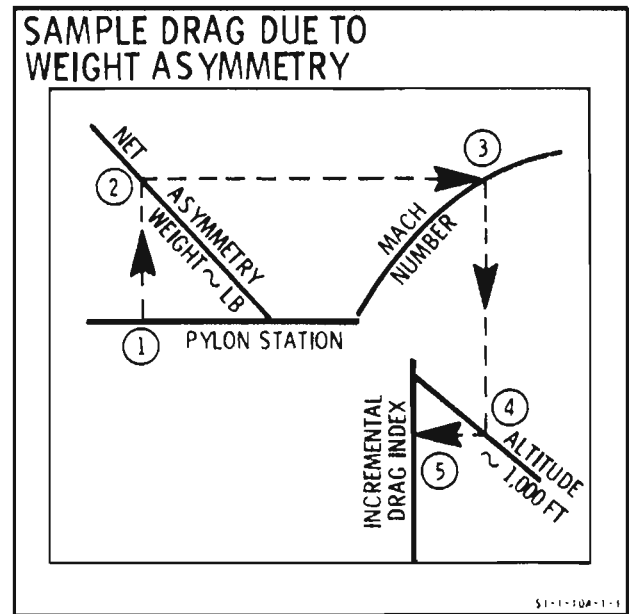

5. Incremental drag index

0.27

ALTITUDE AND AIRSPEED INSTALLATION ERROR CORRECTION

Static pressure, which affects both airspeed and altimeter indications, is not always accurately measured because of the location of the static ports. This pressure error is a function of airspeed. KCAS is obtained from KIAS by correcting for the installation error in static pressure (airspeed installation error). Knowing indicated airspeed, both airspeed and altitude installation error corrections may be read from figure A1-3.

ALTIMETER LAG CORRECTION

Altimeter lag is the difference in the actual altitude and the altitude read on the altimeter when climbing or descending. The amount of lag varies with the altitude and the rate of climb or descent. Altimeter lag correction for the RESET and STBY modes is presented on figure A1-4 for dive conditions. The magnitude of the correction is the same during a climb but the correction sign will change.

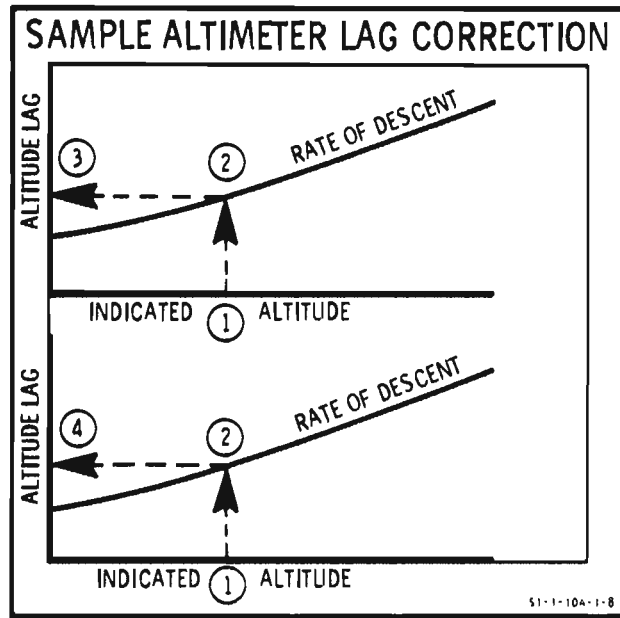
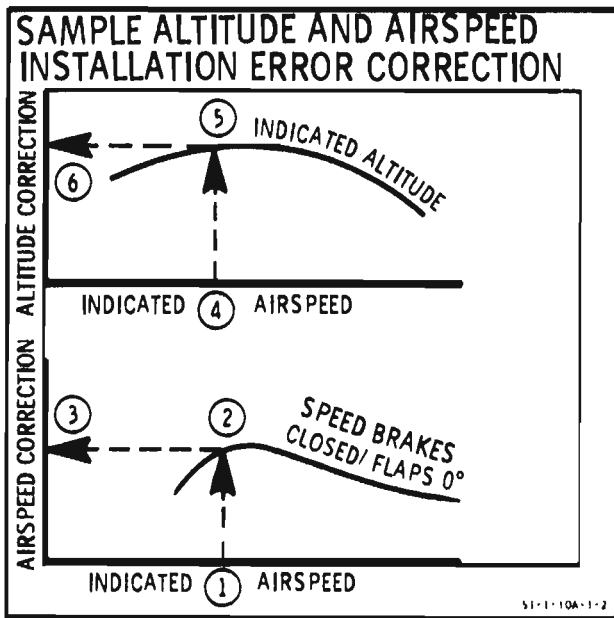

Sample Problem

Given:

- A. Indicated altitude = 25,000 ft
- B. Rate of descent = 15,000 ft/min

Calculate:

- A. Altimeter lag in both RESET and STBY modes
- B. Use altimeter lag correction chart, figure A1-4

- | | |
|--|---------------|
| 1. Indicated altitude | 25,000 ft |
| 2. Rate of descent | 15,000 ft/min |
| 3. Altimeter lag correction (STBY MODE) | 210 ft |
| 4. Altimeter lag correction (RESET MODE) | 187 ft |

Therefore, actual altitude is 25,000 ft - 210 ft = 24,790 ft for the STBY mode, and 25,000 ft - 187 ft = 24,813 ft for the RESET mode.

AIRSPEED CONVERSION

Figure A1-5 is used to convert between KCAS, true Mach number, and true airspeed. If KCAS is known, enter the chart at that value and move up to the known pressure altitude. At that point, true Mach number is read on the left scale and true airspeed for standard atmosphere conditions is interpolated between the sloping speed lines whose scale is located at the sea level pressure altitude line. To correct true airspeed for nonstandard temperatures, move horizontally from the intersection of KCAS and the known altitude to the sea level pressure altitude line, then vertically down to the known ambient temperature at altitude and read the corrected true airspeed on the scale at the right.

Sample Problem

Given:

- A. Calibrated airspeed = 225 KCAS
- B. Pressure altitude = 25,000 ft
- C. Temperature (at altitude) = 0°F

Calculate:

A. Mach number, true airspeed at non-standard temperature, and true airspeed for standard conditions

B. Use airspeed conversion chart, figure A1-5

1. Calibrated airspeed 225 KCAS
2. Pressure altitude 25,000 ft
3. Mach number 0.548
4. Go to SL line
5. Temperature at altitude 0°F
6. True airspeed 340 KTAS
7. True airspeed for standard conditions 330 KTAS

STANDARD ATMOSPHERE TABLE

Significant properties of the U.S. standard atmosphere are tabulated at 1000-foot increments between -2000 feet and 65,000 feet altitude on figure A1-6. Sea level values of the properties are listed in the top

of the chart for use with the ratios shown in the table. As an example of the use of the chart, find the equivalent airspeed in knots in standard atmosphere corresponding to 0.50 Mach number at 30,000 feet pressure altitude. On figure A1-6, at 30,000 feet read $a/a_0 = 0.8909$, read $1/\sqrt{\sigma} = 1.6349$, and at the top of the table read $a_0 = 661.7$ knots.

Then: $a = a_0 \times a/a_0 = 661.7 \times 0.8909 = 589.5$ knots

KTAS = Mach \times a = 0.50 \times 589.5 = 294.8 knots

KEAS = KTAS \div $1/\sqrt{\sigma} = 294.8 \div 1.6349 = 180.3$ knots

TEMPERATURE CONVERSION

The temperature conversion chart, figure A1-7, is a plot of degrees Fahrenheit versus degrees Centigrade.

FUEL DENSITY

The fuel density chart, figure A1-8, presents the density of various fuels as a function of the fuel temperature. The fuels shown are JP-4, JP-5, and JP-8.

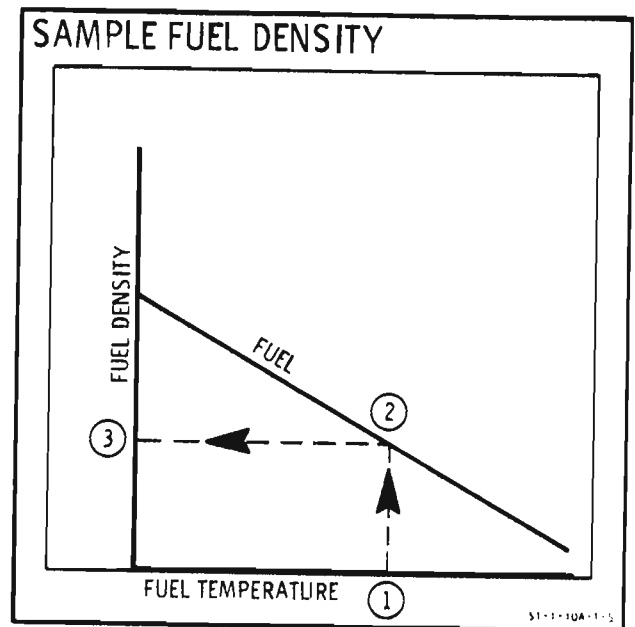
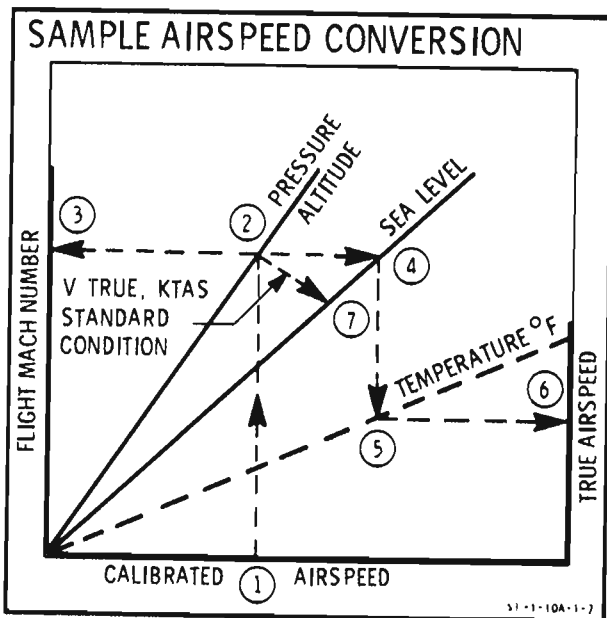

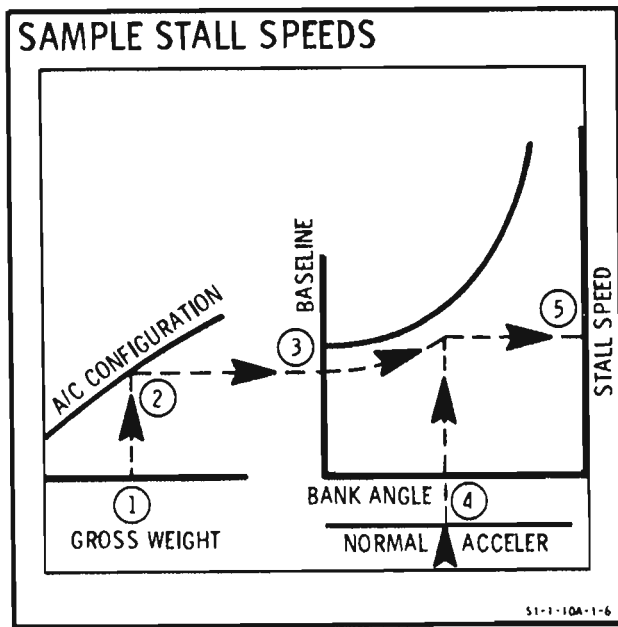

STALL SPEEDS

Stall speeds are presented on figure A1-9 as a function of aircraft gross weight, bank angle or acceleration, and configuration. The user enters the chart with the aircraft gross weight and proceeds vertically up to the appropriate configuration line. From this point, project to the right to the baseline to find 1g stall speed. If aircraft is in a bank, follow guidelines until it is directly above the bank angle (or acceleration) desired. From here, project to the right to read stall speed.

A-10A STORES DRAG

Interference drag exists and is included in the individual drag indexes, where significant.

Refer to applicable weight and balance data for exact weight of aircraft to be flown.

Baseline aircraft (drag index = 0) is clean with 11 pylons installed; leading edge slats retracted; Pave Penny pylon and pod installed; and chaff/flare with cover plates installed.

DI = Drag Index**NOTE**

On all charts, drag index = 0 (baseline) includes all drag associated with conditions, when specified in title block.

I. Suspension Equipment

<u>Suspension Equipment</u>	<u>Gross Wt, Each (Lb)</u>	<u>Drag Index, Each</u>
LAU-117/A	130	0.58
TER-9/A	95	0.51
LAU-88/A	465	0.61

II. Stores

Note: Suspension equipment not included

<u>Store</u>	<u>Gross Wt, Each (Lb)</u>	<u>Drag Index, Each</u>
600-gallon fuel tank	551	0.86
MK-20 (Rockeye)	486	0.37
MK-20 on TER	486	0.55
MK-36 (Destructor)	550	0.26
MK-36 on TER	550	0.39
MK-82 LDGP	505	0.20
MK-82 LDGP on TER	505	0.25
MK-82 HDGP (Snakeye)	550	0.26
MK-84 HDGP on TER	550	0.36
MK-84 LDGP	1,970	0.50

Figure A1-1 (Sheet 1 of 4)

A-10A STORES DRAG

Store	Gross Wt, Each (Lb)	Drag Index, Each
SUU-20B/A Training		
Dispenser Full (with 6		
BDU-33/B, A/B, D/B,		
B/B) (on 14" suspension) - 418		
(with 4-2.75 FFAR-MK-61) - 348		0.60
Full (on 14" suspension)		0.60
(with 6 BDU-33/B, A/B,		
B/B, D/B and 4-2.75		
FFAR-MK-61) (on 14"		
suspension) - 502		0.60
- Empty - 276		0.70
SUU-23 Gun Pod (Full Ammo)	1,722	0.60
SUU-25 C/A, E/A with		
LUU-2/B or MJU-3 Flares	494	0.45
with MK-24, LUU-1/B,		
LUU-5/B or LUU-6/B	470	0.45
- Empty	264	
BDU-33 A/B, B/B, D/B	23	0.02
CBU-52	785	0.38
CBU-58	810	0.38
CBU-71	810	0.38
BL-755	610	0.63
BLU-52	360	0.33
GBU-8	2,260	0.80
GBU-10	2,061	0.71
GBU-12	619	0.51
LAU-68 A/A, B/A (Full - cap on)	191	0.27
(Empty - cap off)	67	0.79
AGM-65A, AGM-65B	464	0.35
TGM-65A	464	0.35
MXU-648 (Cargo Pod),		
764077-10 (Empty)	125	0.73
(Full)	425	0.73

Figure A1-1 (Sheet 2 of 4)

A-10A STORES DRAG

<u>Store</u>	<u>Gross Wt, Each (Lb)</u>	<u>Drag Index, Each</u>
MXU-648 (Cargo Pod), 764077-30 & -50 (Empty)	98	0.73
(Full)	398	0.73
AN/ALQ-119(V) -10/-12	576	0.91
AN/ALQ-131	589	0.75
QRC 80-01	635	0.91

III. Configurations

<u>Configuration</u>	<u>Gross Wt, Each (Lb)</u>	<u>Drag Index</u>
Leading edge slats extended	-	2.02
Manual reversion cruise	-	5.0
high AOA (takeoff, landing)	-	7.5
Landing gear extended	-	15.0
Speed brakes 20%	-	10.63
Speed brakes 40%	-	24.3
Speed brakes 80%	-	75.9
UARRSI door open	-	0.30
Pave Penny pod removed	-30	0
Pave Penny pod and pylon removed	-49	-0.02
Flaps 7°	-	5.82
Flaps 20°	-	24.3
Single-engine windmilling	-	1.90
Flare/chaff system removed (Aircraft sernos 73-01665 through 77-0226)	-292	-0.25
Flare/chaff cover plates removed, no cartridges (canisters removed)	-8	0.10

Figure A1-1 (Sheet 3 of 4)

A-10A STORES DRAG

<u>Configuration</u>	<u>Gross Wt, Each (Lb)</u>	<u>Drag Index</u>
Flare (or chaff) fully loaded, no cover plates	328 (246)	0.05
Flare (chaff) fully loaded, with cover plates	336 (254)	0.01
Flare (chaff), all cartridges fired	136 (118)	0.40
Pylons Removed:		
Sta 6 (centerline)	-135	-0.38
Sta 5 or 7	-131	-0.38
Sta 4 or 8	-133	-0.38
Sta 3 or 9	-128	-0.38
Sta 2 or 10	-96	-0.38
Sta 1 or 11	-98	-0.38

AMMUNITION WEIGHTS

<u>30mm Ammo Type</u>	<u>Weight, Complete Round</u>	<u>Projectile Weight</u>	<u>Case Only</u>
HEI	1.50 lb/rd	0.82 lb/rd	0.34 lb/rd
API	1.60 lb/rd	0.97 lb/rd	0.34 lb/rd
TP	1.50 lb/rd	.84 lb/rd	0.34 lb/rd

Figure A1-1 (Sheet 4 of 4)

MODEL : A-10A
 DATE : 30 NOVEMBER 1982
 DATA BASIS : **A . F. FLIGHT TEST**
 ENGINES : (2) TF34-GE-100/-100A

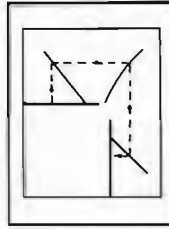

DRAG DUE TO WEIGHT ASYMMETRY

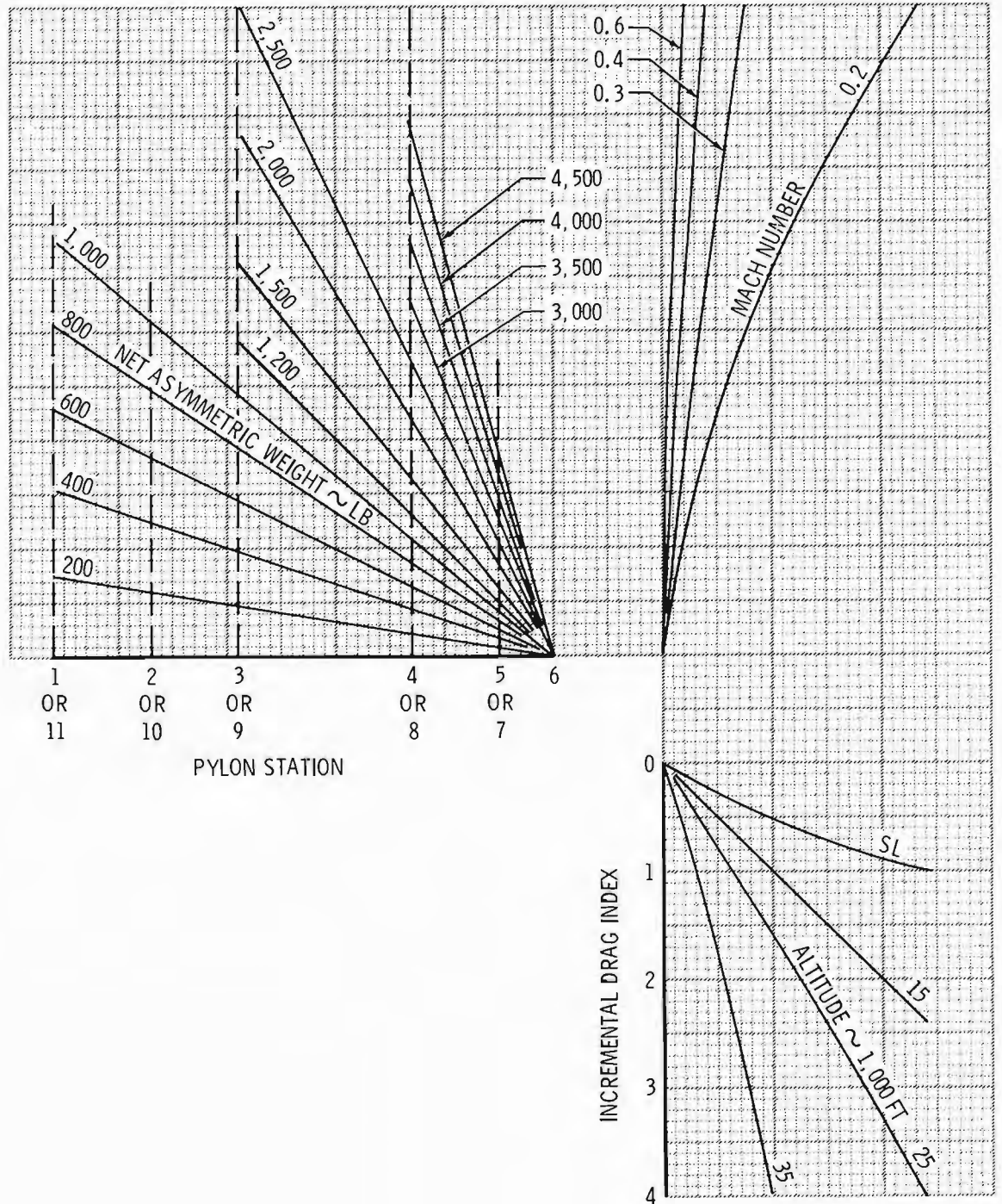

A1-1-10A-1-1

Figure A1-2

**ALTITUDE AND AIRSPEED
INSTALLATION ERROR CORRECTION**
All Gross Weights , Gear Up or Down

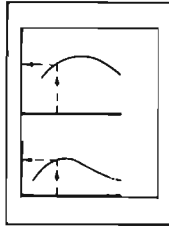

MODEL : A-10A
DATE : 30 NOVEMBER 1982
DATA BASIS : **A . F . FLIGHT TEST**
ENGINES : (2) TF34-GE-100/-100A

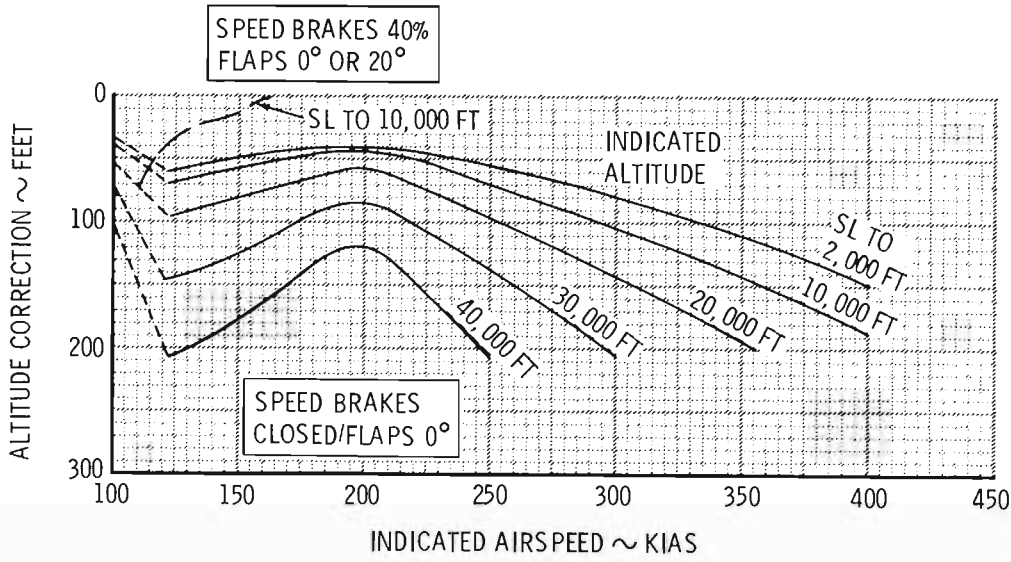

NOTE
Actual altitude is indicated altitude less the corrections.

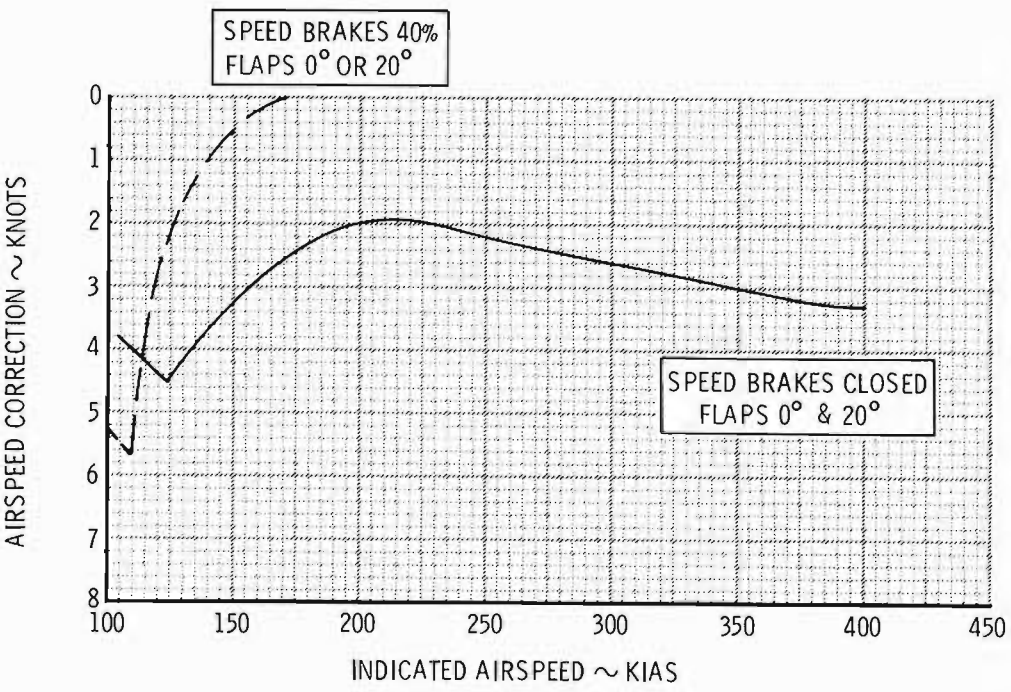

NOTE
Calibrated airspeed is indicated airspeed less the correction.

A 1-1-10A-1-2

Figure A1-3

MODEL : A-10A
 DATE : 30 NOVEMBER 1982
 DATA BASIS : A . F . FLIGHT TEST
 ENGINES : (2) TF34-GE-100/-100A

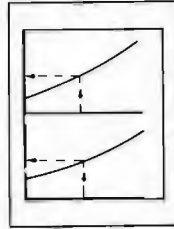

**ALTIMETER
LAG CORRECTION**

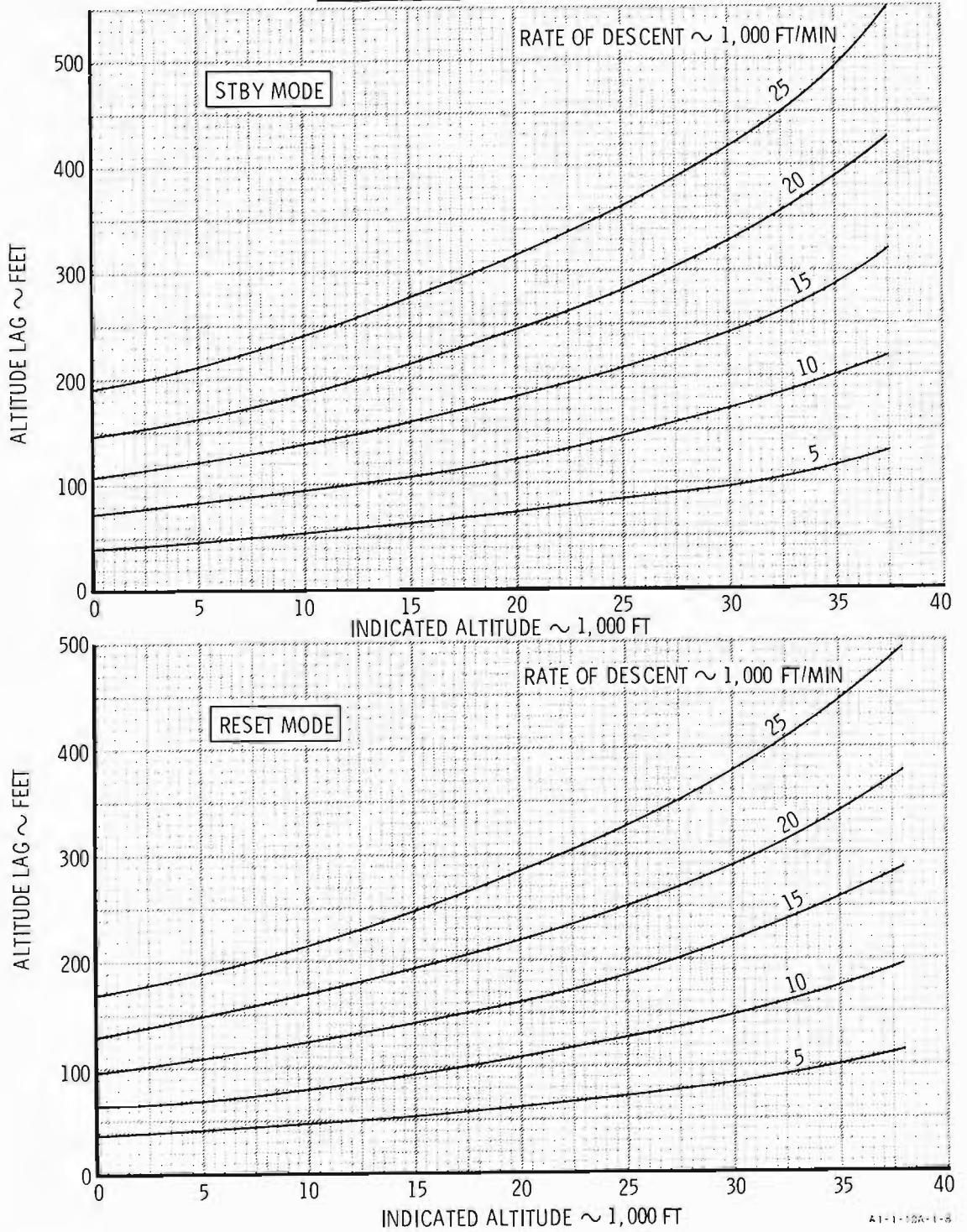
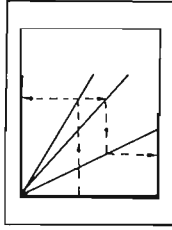
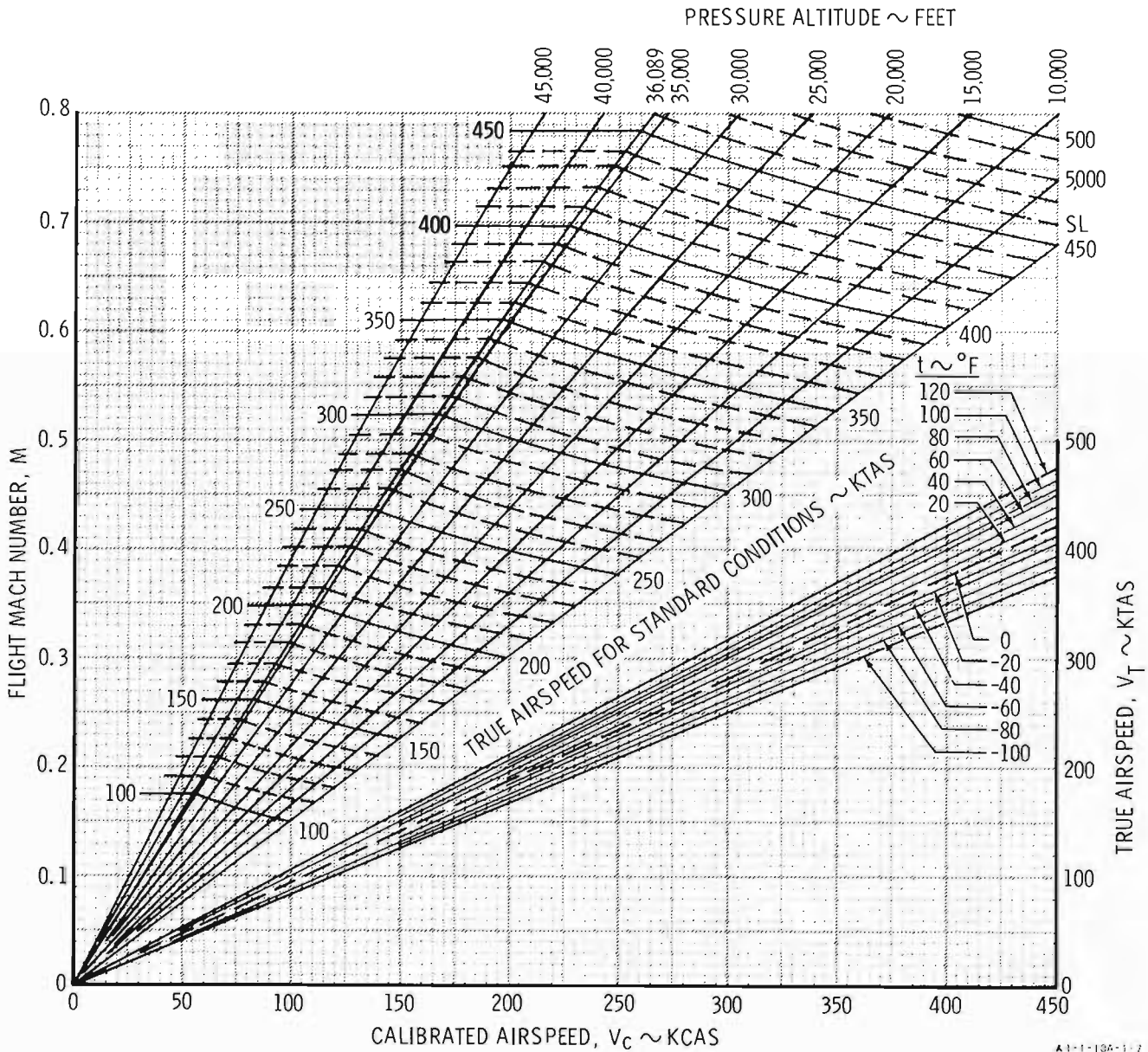

Figure A1-4

AIRSPEED CONVERSION



MODEL : A-10A
 DATE : 30 NOVEMBER 1982
 DATA BASIS : **A . F . FLIGHT TEST**
 ENGINES : (2) TF34-GE-100/-100A



A 1-1-10A-1-7

Figure A1-5

STANDARD ATMOSPHERE TABLE

STANDARD SEA LEVEL AIR:

T = 59°F (15°C)

P = 29.921 IN. OF HG

W = 0.076475 LB/CU FT $\rho_0 = 0.0023769$ SLUGS/CU FT

1 IN. OF HG = 70.732 LB/SQ FT = 0.4912 LB/SQ IN.

$a_0 = 1116.89$ FT/SEC = 661.7 KN

U.S. STANDARD ATMOSPHERE, 1966

ALTITUDE FEET	DENSITY RATIO $\rho/\rho_0 = \sigma$	$1/\sqrt{\sigma}$	AIR TEMPERATURE		SPEED OF SOUND RATIO a/a_0	PRESSURE	
			DEG. F	DEG. C		IN. OF HG	RATIO $P/P_0 = \delta$
- 2,000	1.0598	0.9714	66.132	18.962	1.0064	32.15	1.0294
- 1,000	1.0296	0.9855	62.566	16.981	1.0030	31.02	1.0147
0	1.0000	1.0000	59.000	15.000	1.0000	29.92	1.0000
1,000	0.9711	1.0148	55.434	13.019	0.9966	28.86	0.9644
2,000	0.9428	1.0299	51.868	11.038	0.9931	27.82	0.9298
3,000	0.9151	1.0454	48.302	9.057	0.9896	26.82	0.8962
4,000	0.8881	1.0611	44.735	7.075	0.9862	25.84	0.8637
5,000	0.8617	1.0773	41.169	5.094	0.9827	24.90	0.8320
6,000	0.8359	1.0938	37.603	3.113	0.9792	23.98	0.8014
7,000	0.8106	1.1107	34.037	1.132	0.9756	23.09	0.7716
8,000	0.7860	1.1279	30.471	- 0.849	0.9721	22.22	0.7428
9,000	0.7620	1.1456	26.905	- 2.831	0.9686	21.39	0.7148
10,000	0.7385	1.1637	23.338	- 4.812	0.9650	20.58	0.6877
11,000	0.7156	1.1822	19.772	- 6.793	0.9614	19.79	0.6614
12,000	0.6932	1.2011	16.206	- 8.774	0.9579	19.03	0.6360
13,000	0.6713	1.2203	12.640	- 10.756	0.9543	18.29	0.6113
14,000	0.6500	1.2403	9.074	- 12.737	0.9507	17.58	0.5875
15,000	0.6292	1.2606	5.508	- 14.718	0.9470	16.89	0.5643
16,000	0.6090	1.2815	1.941	- 16.699	0.9434	16.22	0.5420
17,000	0.5892	1.3028	- 1.625	- 18.681	0.9397	15.57	0.5203
18,000	0.5699	1.3246	- 5.191	- 20.662	0.9361	14.94	0.4994
19,000	0.5511	1.3470	- 8.757	- 22.643	0.9324	14.34	0.4791
20,000	0.5328	1.3700	- 12.323	- 24.624	0.9287	13.75	0.4598
21,000	0.5150	1.3935	- 15.889	- 26.605	0.9250	13.18	0.4406
22,000	0.4976	1.4176	- 19.456	- 28.587	0.9213	12.64	0.4223
23,000	0.4807	1.4424	- 23.022	- 30.568	0.9175	12.11	0.4046
24,000	0.4642	1.4678	- 26.588	- 32.549	0.9138	11.60	0.3876
25,000	0.4481	1.4938	- 30.154	- 34.530	0.9100	11.10	0.3711
26,000	0.4325	1.5206	- 33.720	- 36.511	0.9062	10.63	0.3552
27,000	0.4173	1.5480	- 37.286	- 38.492	0.9024	10.17	0.3398
28,000	0.4025	1.5762	- 40.852	- 40.473	0.8986	9.725	0.3250
29,000	0.3881	1.6052	- 44.419	- 42.455	0.8948	9.297	0.3107
30,000	0.3741	1.6349	- 47.985	- 44.436	0.8909	8.885	0.2970
31,000	0.3605	1.6654	- 51.551	- 46.417	0.8871	8.488	0.2837
32,000	0.3473	1.6968	- 55.117	- 48.398	0.8832	8.106	0.2709
33,000	0.3345	1.7291	- 58.683	- 50.379	0.8793	7.737	0.2586
34,000	0.3220	1.7623	- 62.249	- 52.361	0.8754	7.382	0.2467
35,000	0.3099	1.7964	- 65.816	- 54.342	0.8714	7.041	0.2353
36,000	0.2981	1.8315	- 69.382	- 56.323	0.8675	6.712	0.2243
37,000	0.2864	1.8753	- 72.948	- 58.304	0.8637	6.397	0.2138
38,000	0.2750	1.9209	- 76.514	- 60.285	0.8600	6.097	0.2038
39,000	0.2638	1.9677	- 80.080	- 62.266	0.8563	5.811	0.1942
40,000	0.2528	2.0155	- 83.646	- 64.247	0.8526	5.538	0.1851
41,000	0.2420	2.0645	- 87.212	- 66.228	0.8489	5.278	0.1764
42,000	0.2314	2.1148	- 90.778	- 68.209	0.8452	5.030	0.1681
43,000	0.2211	2.1662	- 94.344	- 70.190	0.8415	4.794	0.1602
44,000	0.2111	2.2189	- 97.910	- 72.171	0.8378	4.569	0.1527
45,000	0.1936	2.2728	- 101.476	- 74.152	0.8341	4.355	0.1455
46,000	0.1845	2.3281	- 105.042	- 76.133	0.8304	4.151	0.1387
47,000	0.1758	2.3848	- 108.608	- 78.114	0.8267	3.956	0.1322
48,000	0.1676	2.4428	- 112.174	- 80.095	0.8230	3.770	0.1260
49,000	0.1597	2.5022	- 115.740	- 82.076	0.8193	3.593	0.1201
50,000	0.1522	2.5630	- 119.306	- 84.057	0.8156	3.425	0.1145
51,000	0.1451	2.6254	- 122.872	- 86.038	0.8119	3.264	0.1091
52,000	0.1383	2.6892	- 126.438	- 88.019	0.8082	3.111	0.1040
53,000	0.1318	2.7546	- 130.004	- 90.000	0.8045	2.965	0.09909
54,000	0.1256	2.8216	- 133.570	- 92.000	0.8008	2.826	0.09444
55,000	0.1197	2.8903	- 137.136	- 94.000	0.7971	2.693	0.09001
56,000	0.1141	2.9606	- 140.702	- 96.000	0.7934	2.567	0.08578
57,000	0.1087	3.0326	- 144.268	- 98.000	0.7897	2.446	0.08176
58,000	0.1036	3.1063	- 147.834	- 100.000	0.7860	2.331	0.07792
59,000	0.09877	3.1819	- 151.400	- 102.000	0.7823	2.222	0.07426
60,000	0.09414	3.2593	- 154.966	- 104.000	0.7786	2.118	0.07078
61,000	0.08972	3.3386	- 158.532	- 106.000	0.7749	2.018	0.06746
62,000	0.08551	3.4198	- 162.098	- 108.000	0.7712	1.924	0.06429
63,000	0.08150	3.5029	- 165.664	- 110.000	0.7675	1.833	0.06127
64,000	0.07767	3.5881	- 169.230	- 112.000	0.7638	1.747	0.05840
65,000	0.07403	3.6754	- 172.796	- 114.000	0.7601	1.665	0.05566

1-1-10A-1-3

Figure A1-6

TEMPERATURE CONVERSION CHART

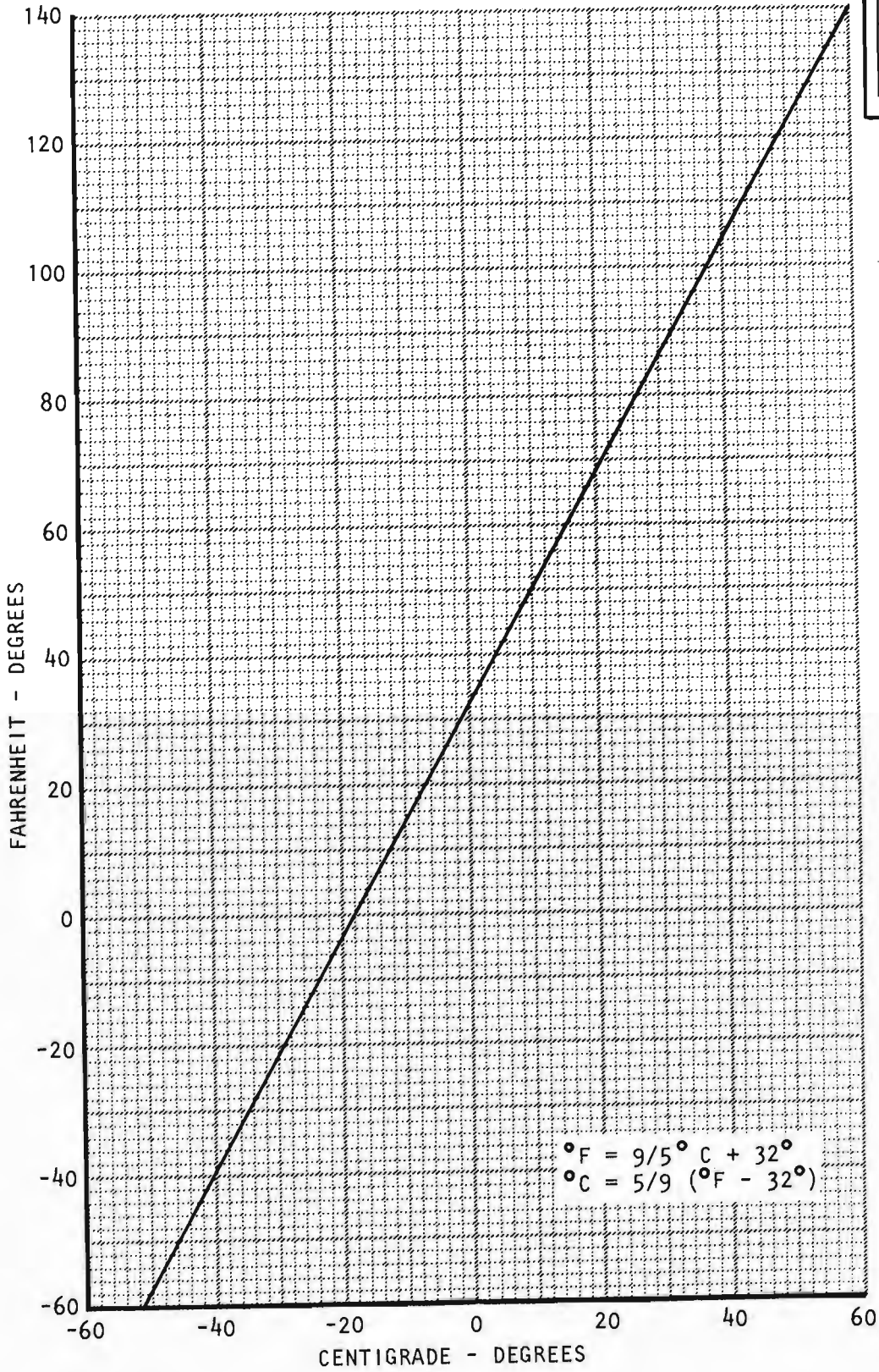
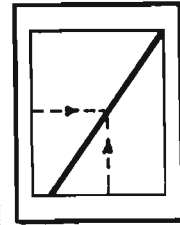

1-1-10A-1-4

Figure A1-7

MODEL : A-10A
DATE : 30 NOVEMBER 1982
DATA BASIS : **A.F. FLIGHT TEST**
ENGINES : (2) TF34-GE-100/-100A

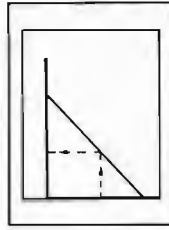

FUEL DENSITY

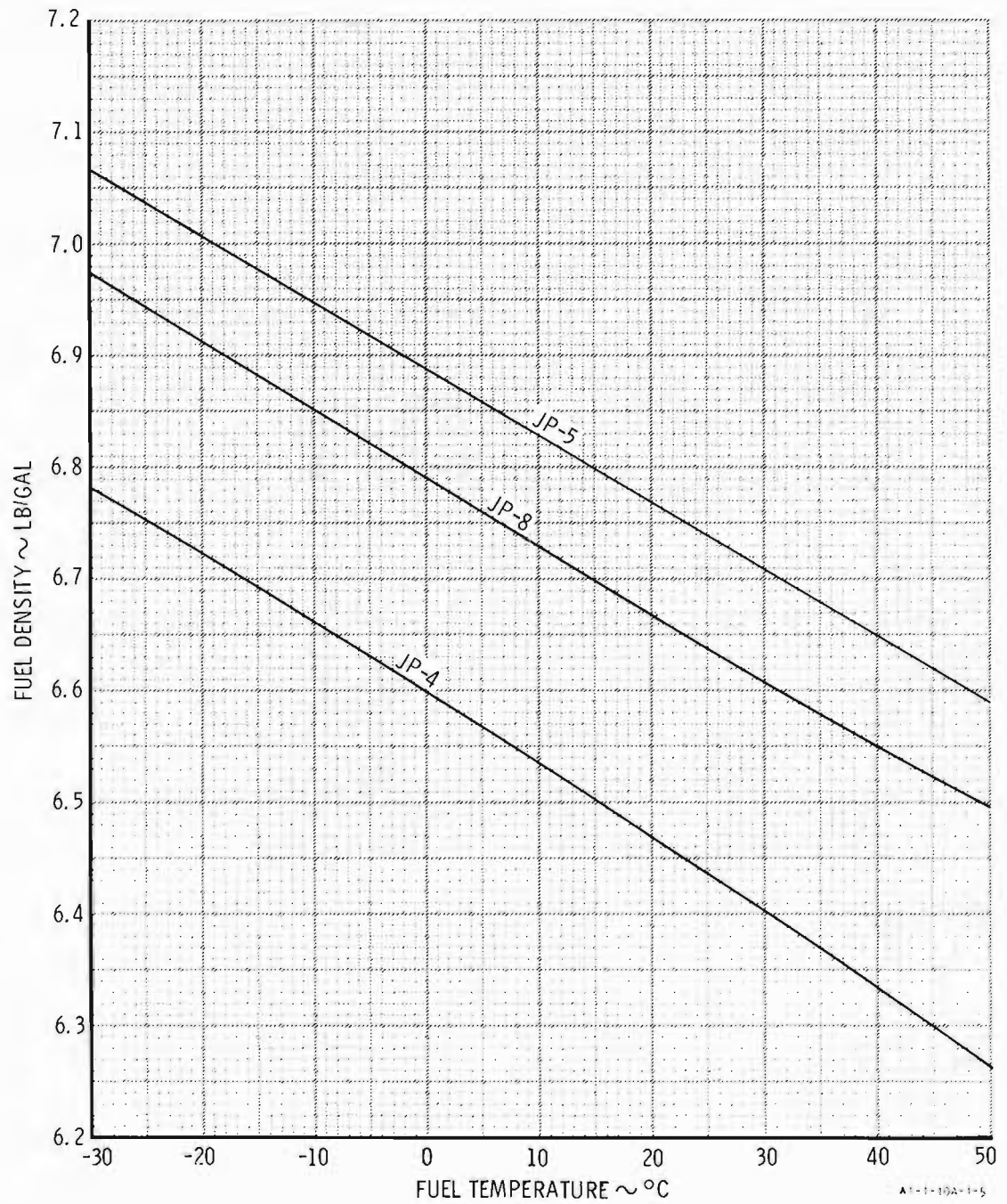

A1-1-10A-1-5

Figure A1-8

STALL SPEEDS

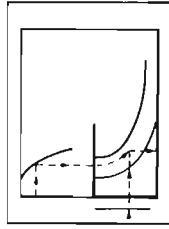

MODEL : A-10A
 DATE : 30 NOVEMBER 1982
 DATA BASIS : **A.F. FLIGHT TEST**
 ENGINES : (2) TF34-GE-100/-100A

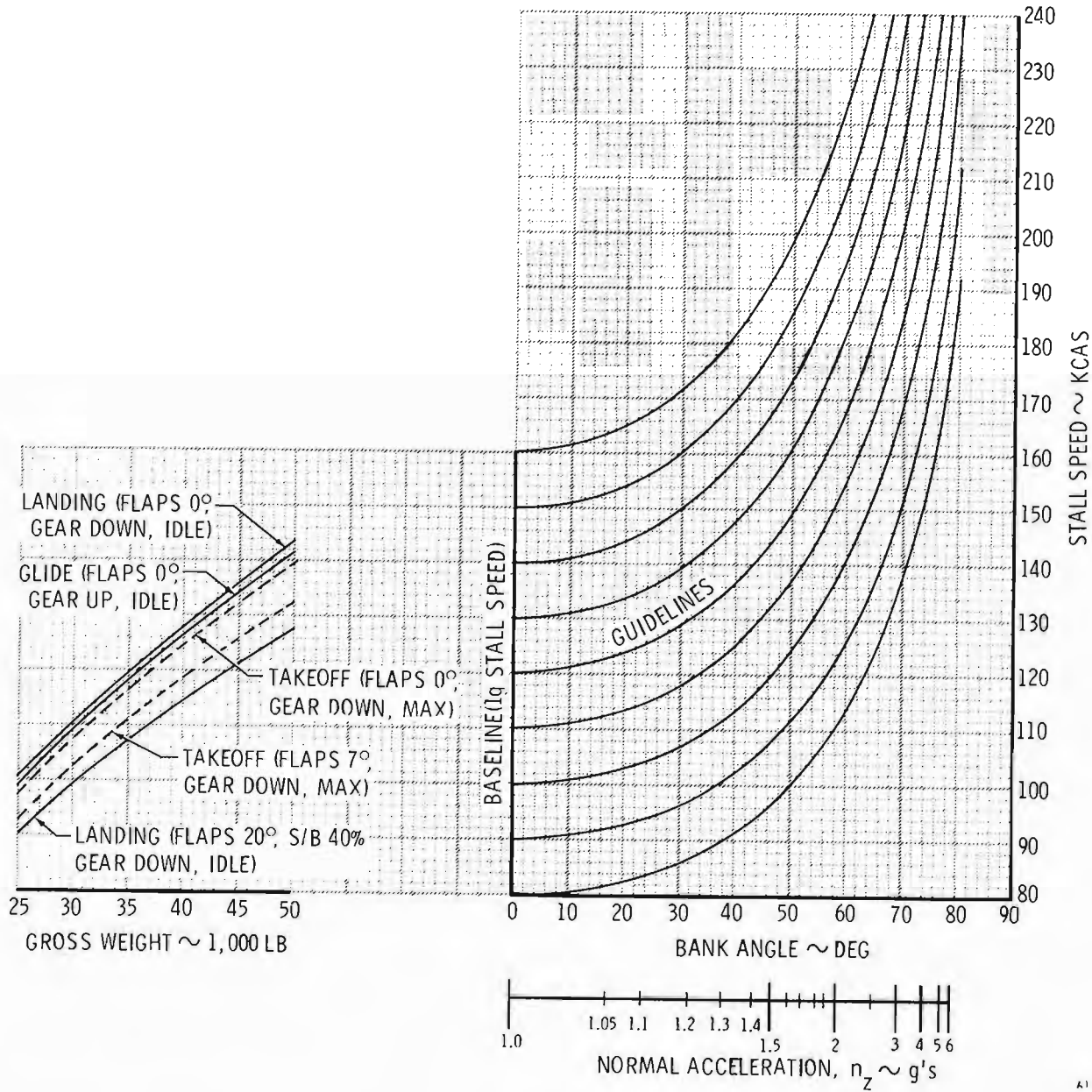

A1-1-10A-1-6

Figure A1-9

PART II
TAKEOFF
TABLE OF CONTENTS

	Page
Takeoff Performance Charts (General)	A2-2
Definition of Terms	A2-2
Takeoff Planning	A2-3
Rotation and Takeoff Speed Chart	A2-4
Single-Engine Rate of Climb Chart.....	A2-5
Takeoff Index Chart.....	A2-6
Takeoff Ground Run Charts.....	A2-6
50-Foot Obstacle Clearance Distance Charts	A2-7
RCR Without Anti-Skid Chart	A2-8
Critical Field Length Chart.....	A2-8
Refusal Speed Chart.....	A2-9
Continuation Speed Chart	A2-10
Wheel Brake Energy Limit Speed Chart.....	A2-11
Acceleration Check Speed Chart	A2-12
Runway Wind Components Chart.....	A2-13
Abort Takeoff Charts (General)	A2-14
Fan Speed Required for Predicted Takeoff Performance	A2-14
Minimum Fan Speeds Required for Desired Single-Engine Rates-of-Climb	A2-14A

CHARTS

Figure	Title	Page
A2-1	Takeoff/Abort Criteria	A2-15
A2-2	Rotation and Takeoff Speed.....	A2-17
A2-3	Single-Engine Rate of Climb.....	A2-18
A2-4	Takeoff Index	A2-19
A2-5	Takeoff Ground Run Flaps 0°.....	A2-20
A2-6	Takeoff Ground Run Flaps 7°.....	A2-21
A2-7	50 Ft. Obstacle Clearance Distance Maximum Thrust.....	A2-22
A2-8	50 Ft. Obstacle Clearance Distance 3% Below PTFS	A2-23
A2-9	RCR Without Anti-Skid	A2-24
A2-10	Critical Field Length.....	A2-25
A2-11	Refusal Speed.....	A2-26
A2-12	Continuation Speed	A2-27
A2-12-A	Continuation Speed (Best S.E. R/C Speed Used as Takeoff Speed) ..	A2-28A
A2-13	Wheel Brake Energy Limit Speed.....	A2-28B
A2-14	Acceleration Check Speed	A2-29
A2-15	Runway Wind Components	A2-30
A2-16	Predicted Takeoff Fan Speed (PTFS).....	A2-31
A2-17	Required Fan Speeds for Single Engine Rates of Climb	A2-32/A2-33
A2-18	Required Fan Speeds for Single Engine Rates of Climb	A2-34/-35
A2-19	Required Fan Speeds for Single Engine Rates of Climb	A2-36
A2-20	Required Fan Speeds for Single Engine Rates of Climb	A2-37

TAKEOFF PERFORMANCE CHARTS (GENERAL)

All data needed for takeoff planning are presented in this section. The takeoff charts provide a means of determining takeoff performance under normal operating conditions. Takeoff performance is affected by a large number of variables; among them are ambient temperature, pressure altitude, gross weight, thrust setting, runway slope, runway condition, wind component, and flap deflection. Charts including these variables are provided for single-engine rates of climb, takeoff speeds and distances, 50-foot obstacle clearance distances, critical field length, and continuation, refusal, and acceleration check speeds. Takeoff distance and 50-foot obstacle clearance distance charts consider only two-engine operation.

WARNING

- Takeoff distances for unimproved surfaces will be significantly increased and have not been substantiated by flight tests.

PREDICTED TAKEOFF FAN SPEED (PTFS)

All takeoff data are based on predicted engine performance at maximum droop conditions. Engine fan speed is used to determine whether the engine is providing the predicted thrust. Figure A2-16 provides the fan speed required at various temperatures to obtain computed takeoff performance. The takeoff data are valid only if the predicted fan speed is achieved.

DEFINITION OF TERMS

A graphic representation of several of the following definitions is given on figure A2-1.

Rotation Speed

The airspeed at which the pilot initiates back (aft) stick pressure to achieve a rotation rate that will result in a takeoff attitude of 10° at the recommended takeoff speed (approximately 10 KIAS prior to takeoff speed).

Takeoff Speed

The airspeed at which the main landing gear lifts from the runway.

Single-Engine Rate of Climb

Rate of climb at takeoff speed, one engine at maximum thrust, one engine windmilling, flaps 7°, and landing gear down.

Takeoff Index

A computed number that is a function of engine thrust, temperature, and pressure altitude. Used as a control parameter for most charts in this section.

Takeoff Ground Run (also Takeoff Distance)

Ground run in feet from brake release to takeoff speed.

Runway Slope

Change in runway elevation divided by runway length multiplied by 100 (expressed in percent uphill or downhill).

Runway Elevation

Runway altitude above sea level (all altitudes shown in this section are pressure altitudes).

50-Foot Obstacle Clearance Distance

Horizontal distance from brake release to vertically clearing a 50-foot obstacle height.

Runway Condition Reading (RCR)

Number portion of a system of reporting runway surface conditions (related to braking effectiveness).

Critical Field Length

Total distance required for the aircraft to accelerate on both engines to the critical engine failure speed, experience an engine failure, and then either continue the takeoff or stop.

Critical Engine Failure Speed

Speed to which the aircraft can be accelerated on both engines, experience an engine failure, and then continue the takeoff or stop in the same distance (computed critical field length).

Refusal Speed (or Maximum Abort Speed)

Maximum speed to which the aircraft can accelerate with dual-engine thrust, and then stop in the remaining runway length.

Continuation Speed (or Minimum Go-Speed)

Minimum speed from which takeoff speed can be attained in the remaining runway length with one engine at maximum thrust and one engine inoperative (windmilling).

Acceleration Check Speed

Minimum speed at end of acceleration check time or distance. Acceleration check speed should be less than refusal speed.

Single-Engine Acceleration

Acceleration with one engine operating at maximum thrust and one engine inoperative (windmilling).

Braked Deceleration

Deceleration on runway aided by application of brakes.

Wheel Brake Energy Limit Speed

Highest speed from which the aircraft may be brought to a stop without exceeding the maximum design energy absorption capability of the brakes. Wheel brake energy limit speed is compared, in takeoff planning, with refusal speed.

TAKEOFF PLANNING

Careful and thorough takeoff planning is essential from a standpoint of flight safety and mission success. Proper planning will permit maximum use of the capability of the aircraft to take off with heavy payloads while maintaining adequate safety margins. Takeoff planning is comprised of the following:

1. Determine aircraft configuration (total aircraft takeoff gross weight, drag index, flap setting, etc.). Normal takeoffs will be

accomplished with 7° flap deflection and maximum thrust.

2. Obtain field conditions for expected takeoff time (pressure altitude, temperature, wind, runway length, slope, condition, etc.).

3. Compute the following data from the charts in this section:

a. Single-engine rate of climb at takeoff speed with gear down. For best single-engine rate of climb and corresponding speed, refer to Part III.

b. Takeoff index, which will be used to enter most other charts in this section.

c. Critical field length (A positive gear down single-engine rate of climb must be available to compute critical field length).

d. Takeoff speed

e. Rotation speed

f. Takeoff ground distance

g. 50-foot obstacle clearance distance

h. Refusal speed

i. Continuation speed (Positive gear down single-engine rate of climb must be available)

j. Acceleration check speed

This information will permit decisions to be made regarding any necessary down-loading, decision to continue or abort take-off in event of an engine failure, obstacle clearance, etc.

Start, Taxi, Takeoff, and Acceleration to Climb Speed Planning Factors

Fuel used	500 lb
Distance (brake release to climb speed)	2 NM
Time (brake release to climb speed)	1 min

Note

The 500-pound fuel value is based on approximately 600 pounds/hour idle fuel flow, for ground operations (300 pounds/30 minutes) and a worst case fuel consumption of 200 pounds for takeoff and acceleration to climb speed. This value may be adjusted accordingly as mission requirements dictate.

Each chart is discussed in detail in the following paragraphs. An example takeoff planning problem is worked in conjunction with the discussion. The following typical aircraft and field information is normally determined before entering the charts:

Takeoff weight = 40,000 lb
(aircraft operating weight plus fuel plus internal and external stores)

Flap setting = 7°

Internal and external stores = (6) MK-82 LDGP bombs on (6) pylons located at sta. 1, 3, 5 and 7, 9, 11; 750 rounds of 30mm ammo; full load of M-206 flare cartridges

Takeoff drag index = -0.65
(from figure A1-1)

Runway elevation = 1,000 ft
(pressure altitude)

Temperature = 15 °C

Runway length = 6,000 ft

Runway slope = 1% uphill

Wind = 10 kt headwind

Runway condition = RCR = 23
(Dry concrete)

ROTATION AND TAKEOFF SPEED CHART

The rotation and takeoff speed chart is presented on figure A2-2. Takeoff speed is shown as a function of aircraft takeoff gross weight for flaps 0° and flaps 7°. The chart is intended for use with maximum or 3% below PTFS. Rotation speed is approximately 10 knots less than takeoff speed.

DIRECTIONS FOR USE OF CHART

To obtain takeoff speed, enter the chart with takeoff gross weight, proceed up to the selected flap deflection, and then to the left to read takeoff speed. To obtain rotation speed, subtract 10 KIAS from the takeoff speed.

Sample Problem

Given:

- A. Takeoff gross weight = 40,000 lb
- B. Flap deflection = 7°

Calculate:

- A. Rotation and takeoff speeds
- B. Use rotation and takeoff speed chart, figure A2-2
 - 1. Gross weight 40,000 lb
 - 2. Flap deflection 7°
 - 3. Takeoff speed 137 KIAS
- C. Refer to note on top of chart for determining rotation speed

Thus:

$$\text{Takeoff speed} - 10 \text{ KIAS} = \text{rotation speed}$$

$$137 \text{ KIAS} - 10 \text{ KIAS} = 127 \text{ KIAS}$$

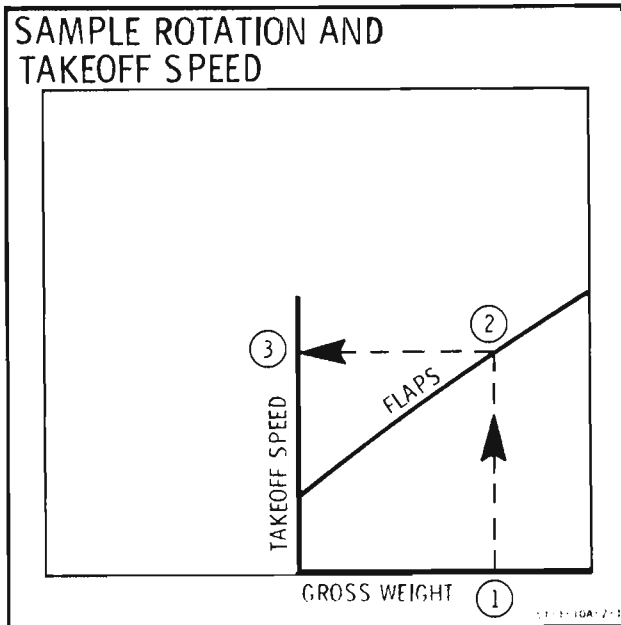

SINGLE-ENGINE RATE OF CLIMB CHART

Single-engine rate of climb capability data are presented on figure A2-3. The data are based on takeoff airspeed with one engine operating at maximum thrust, and the other engine windmilling. The chart presents the single-engine rate of climb at takeoff speed for flaps 7°, landing gear down as a function of runway temperature, pressure altitude, gross weight, and drag index. Corrections for flaps 0°, landing gear up, and/or reduced thrust setting are presented on the chart. Maximum takeoff gross weight for a required single-engine climb capability may be easily computed from the chart.

DIRECTIONS FOR USE OF CHART

Enter the chart with runway temperature, proceed horizontally to the right to pressure altitude and then drop down to gross weight. From this point, proceed horizontally to the right to the drag index baseline. Parallel the nearest guideline to the required drag index and then continue to the right to read the single-engine rate of climb. With flaps 0°, add 100 fpm to the chart value. With landing gear up, add 400 fpm to the chart value. For a takeoff with 3% below PTFs, the single-engine rate of climb at takeoff speed is obtained by decreasing the chart value by 250 fpm.

Sample Problem

Given:

- Takeoff thrust setting = MAXIMUM
- Runway temperature = 15°C (59°F)
- Pressure altitude = 1,000 ft
- Takeoff gross weight = 40,000 lb
- Takeoff drag index = -0.65
- Flap setting = 7°

Calculate:

A. Single-engine rate of climb at takeoff speed, maximum thrust, landing gear down

B. Use single-engine rate of climb chart, figure A2-3

- Runway temperature 15°C
- Pressure altitude 1,000 ft
- Takeoff gross weight 40,000 lb
- Go to drag index baseline

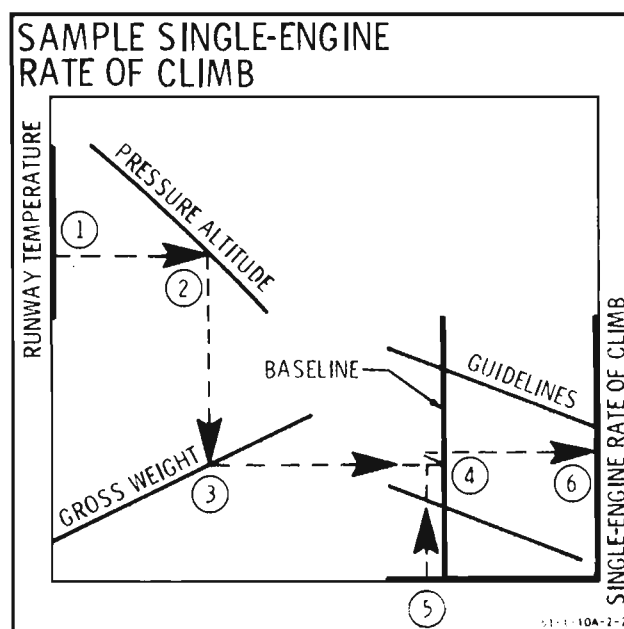

- 5. Drag index -0.65
- 6. Single-engine rate of climb 200 fpm (gear down)

TAKEOFF INDEX CHART

The takeoff index chart for maximum or 3% below PTFS figure A2-4, combines three factors affecting takeoff performance into one quantity, called takeoff index. The three factors are runway temperature, pressure altitude, and engine thrust setting. The takeoff index is determined for the particular conditions of the problem and then used to define takeoff distance, critical field length, and refusal, continuation, and acceleration check speeds.

DIRECTIONS FOR USE OF CHART

Enter the chart with the runway temperature and proceed right to the pressure altitude. At the intersection with the altitude curve, proceed down to the desired thrust setting curve and then left to read the takeoff index.

Sample Problem

Given:

- A. Runway temperature = 15 °C
- B. Runway pressure altitude = 1,000 ft
- C. Takeoff thrust setting = MAXIMUM

Calculate:

- A. Takeoff index
- B. Use takeoff index chart, figure A2-4
 - 1. Runway temperature 15 °C
 - 2. Pressure altitude 1,000 ft
 - 3. Thrust setting MAXIMUM
 - 4. Takeoff index 9.6

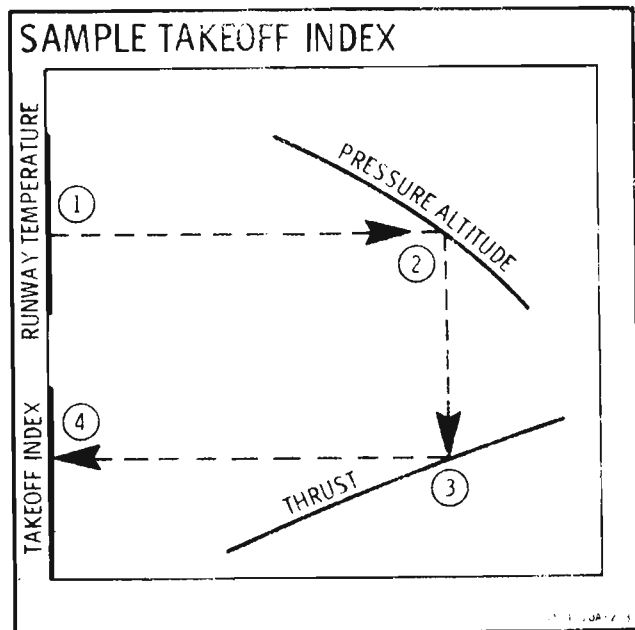

TAKEOFF GROUND RUN CHARTS

Takeoff ground run distances for flaps 0° and flaps 7° are presented on figures A2-5 and A2-6, respectively, as a function of the takeoff index appropriate for maximum or 3% below PTFS. The distances shown are for normal takeoff techniques on a dry, hard-surface runway at the speeds shown on figure A2-2. These charts account for takeoff index, gross weight, wind components, and runway slope. Drag for externally loaded configurations has been accounted for at the various aircraft gross weights.

DIRECTIONS FOR USE OF CHART

Enter the appropriate chart with takeoff index and proceed to the right to the aircraft gross weight. From this point, proceed down to the wind baseline. Contour the guidelines for headwind or tailwind to the wind velocity (if zero wind conditions prevail, proceed directly through), then continue down to the runway slope baseline. Contour the guidelines for uphill or downhill slope to the runway slope (if zero slope condition prevails, proceed directly through). From this point, proceed down to read the required takeoff ground run.

Sample Problem

Given:

- A. Flap deflection = 7°
- B. Takeoff index = 9.6
- C. Takeoff gross weight = 40,000 lb
- D. Headwind = 10 kt
- E. Runway slope = 1% uphill

Calculate:

- A. Takeoff ground run
- B. Use takeoff ground run chart, figure A2-6
 1. Takeoff index 9.6
 2. Takeoff gross weight 40,000 lb
 3. Go to wind correction baseline
 4. Headwind 10 kt
 5. Go to runway slope baseline

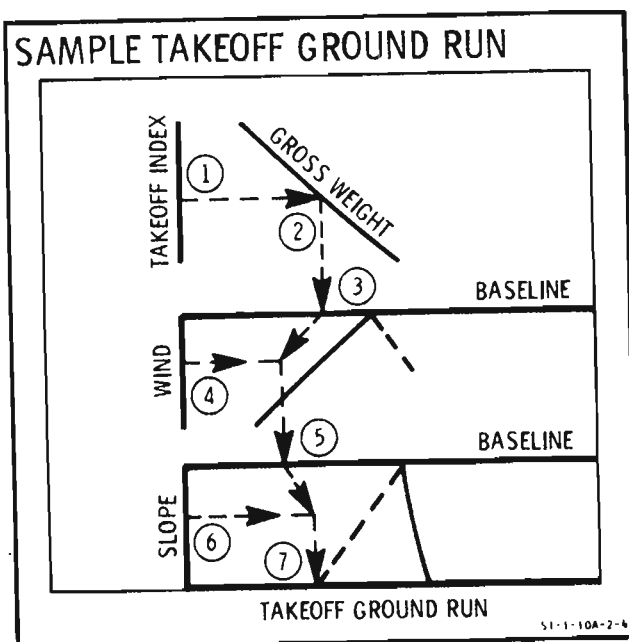

- 6. Runway slope 1% uphill
- 7. Takeoff ground run 2,900 ft

50-FOOT OBSTACLE CLEARANCE DISTANCE CHARTS

The 50-foot obstacle clearance distance charts are presented on figures A2-7 and A2-8 for maximum and 3% below PTFS, respectively. Flaps 0° and 7° are shown on each chart. The charts are shown as a function of takeoff ground run (corrected for headwind or tailwind, and uphill or downhill slope, as appropriate) and wind components. The 50-foot obstacle clearance distance is based on maintaining 10° takeoff attitude.

DIRECTIONS FOR USE OF CHART

Enter appropriate chart with takeoff ground run corrected for wind and runway slope, and proceed up to the required wind curve, then left to read the 50-foot obstacle clearance distance.

Sample Problem

Given:

- A. Thrust setting = MAXIMUM
- B. Flap deflection = 7°
- C. Takeoff ground run = 2,900 ft
- D. Headwind = 10 kt

Calculate:

- A. 50-foot obstacle clearance distance
- B. Use 50-foot obstacle clearance distance chart, figure A2-7. Enter upper chart (flaps 7°)
 1. Takeoff ground run 2,900 ft
 2. Headwind 10 kt
 3. 50-foot obstacle clearance distance 4,250 ft

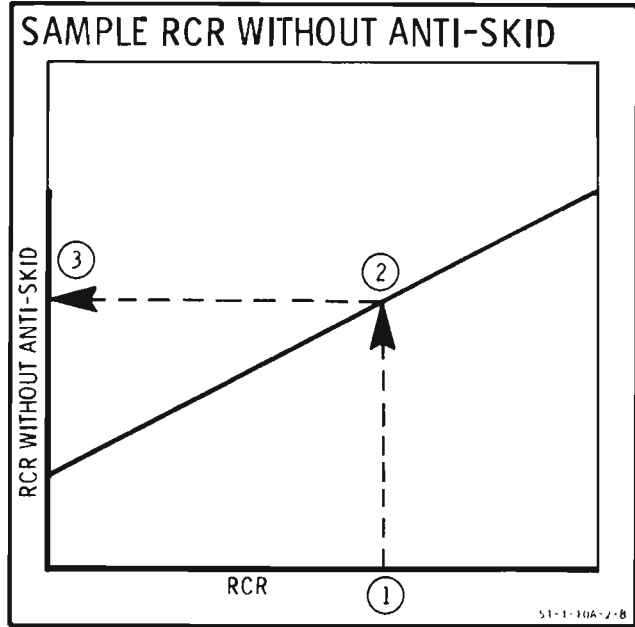
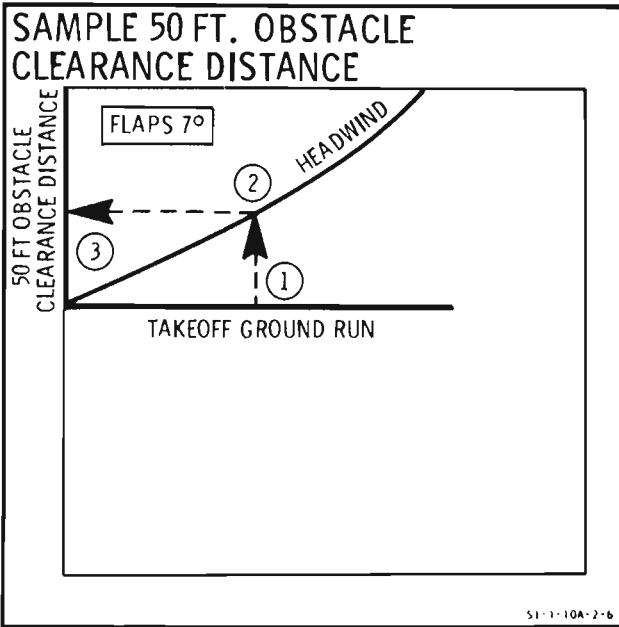

RCR WITHOUT ANTI-SKID CHART

The relationship between the runway condition reading (RCR) with anti-skid and the corresponding RCR without anti-skid is presented on figure A2-9. If the left engine fails, the anti-skid system is nonoperational.

DIRECTIONS FOR USE OF CHART

Enter the chart with the RCR with anti-skid, proceed up to the reflector line, and then to the left to read the RCR without anti-skid.

Sample Problem

Given:

- A. RCR = 23

Calculate:

A. RCR to be used without anti-skid system operational

B. Use RCR without anti-skid chart, figure A2-9

- 1. RCR 23
- 2. Go to reflector line

3. RCR without anti-skid 16

CRITICAL FIELD LENGTH CHART

The critical field length chart is presented on figure A2-10 for flaps 7° and speed brakes open 100%. The chart is intended for use with maximum or 3% below PTFS setting. Distances shown in the chart are based on a two-engine acceleration to engine failure speed, a 3-second pilot reaction time delay, and full braking to stop or single-engine acceleration to take-off speed. Data allows for coastdown to wheel brake energy limit speed where applicable. The chart accounts for take-off index, gross weight, wind components, runway slope, and RCR. Corrections for flaps 0° and/or speed brakes closed are presented on the chart. A positive gear down single-engine rate of climb at takeoff speed must be present for a critical field length to be computed.

DIRECTIONS FOR USE OF CHART

First, check figure A2-2 for the presence of a positive gear down single-engine rate of climb at takeoff speed. If this exists, then enter the chart with takeoff index, proceed horizontally to the right to aircraft gross weight, and then vertically down to the wind baseline. Contour the

nearest guidelines for headwind or tailwind to the wind velocity (if no wind, proceed down from baseline), and then down to the runway slope baseline. Contour the nearest guidelines for uphill or downhill slope to the runway slope (if no slope, proceed down from baseline) and then down to the RCR baseline. Contour the guidelines to the RCR and then continue down to read the critical field length. If operating from a dry, hard-surfaced runway with anti-skid system operational (right engine failure), proceed directly through the RCR correction portion of the chart. With flaps 0° and/or speed brakes closed, add required corrections to the chart value.

Sample Problem

Given:

- A. Takeoff thrust setting = MAXIMUM
- B. Flap deflection = 7°
- C. Speed brake position = open 100% for abort
- D. Takeoff index = 9.6
- E. Gross weight = 40,000 lb
- F. Runway headwind = 10 kt
- G. Runway slope = 1% uphill
- H. Runway condition reading (RCR with no anti-skid) = 16

Calculate:

- A. Critical field length
- B. Use critical field length chart, figure A2-10
 1. Takeoff index 9.6
 2. Gross weight 40,000 lb
 3. Go to wind baseline

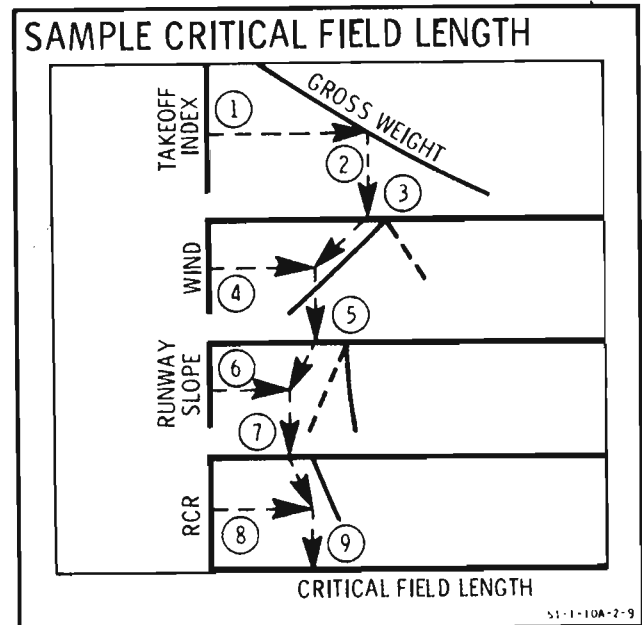

4. Headwind 10 kt
5. Go to runway slope baseline
6. Runway slope 1% uphill
7. Go to RCR baseline
8. RCR (no anti-skid) 16
9. Critical field length 5,000 ft

REFUSAL SPEED CHART

The refusal speed chart is presented on figure A2-11, for speed brakes open 100%. The chart may be used for flaps 0° or 7° and maximum or 3% below PTFS. In addition to takeoff index and aircraft gross weight, the actual runway length is used in the chart to determine refusal speed. A 3-second pilot reaction time is included in the chart. A correction to the refusal speed is also presented for cases when the speed brakes are closed. The computed speeds are always higher with the speed brakes open 100% than with the speed brakes closed because of the shorter stopping distance resulting from the additional deceleration with the speed brakes open 100%.

Note

The wheel brake energy limit speed must be computed, using figure A2-13, and compared to the computed refusal speed. If the wheel brake energy limit speed is less than the refusal speed, use the limit speed as the maximum abort speed.

DIRECTIONS FOR USE OF CHART

Enter the chart with takeoff index and move horizontally to the right to the known value of the actual runway length. Proceed vertically down to the aircraft gross weight and then horizontally to the right to the RCR baseline. Contour the guidelines to the RCR value and then proceed to the right to read the refusal speed. The wind correction is obtained from the note on the chart.

Sample Problem

Given:

- A. Maximum thrust takeoff, flaps 7°, and speed brakes open 100% for abort
- B. Takeoff index = 9.6
- C. Actual runway length = 6,000 ft
- D. Takeoff gross weight = 40,000 lb
- E. Runway condition reading (RCR) = 16
- F. Runway headwind = 10 kt
- G. Runway slope = 1% uphill

Calculate:

- A. Refusal speed
- B. Use refusal speed chart, speed brakes open 100%, figure A2-11
 - 1. Takeoff index 9.6
 - 2. Runway length 6,000 ft

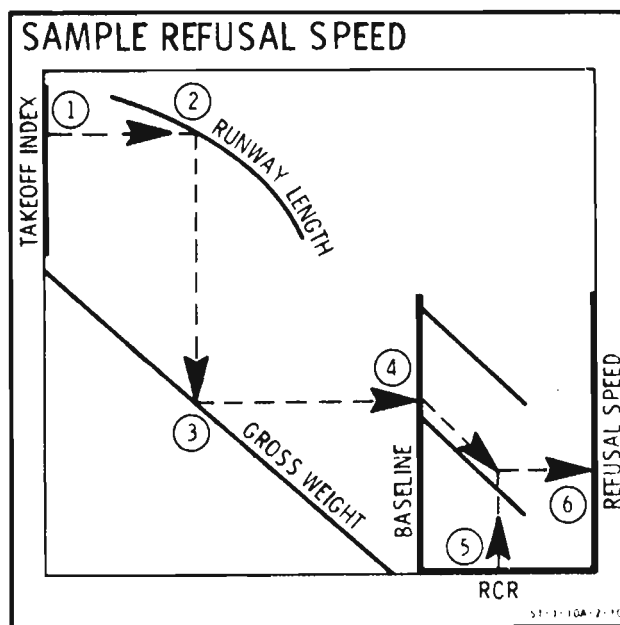

- 3. Gross weight 40,000 lb
 - 4. Go to RCR baseline
 - 5. RCR 16
 - 6. Refusal speed (zero wind) 118 KIAS
- Correction for headwind
(see note on chart) +10 KIAS
- Corrected refusal speed
(for RCR = 16 and 10 kt headwind) 128 KIAS

CONTINUATION SPEED CHART

Continuation speeds presented on figure A2-12 are based on the minimum speed from which a successful single-engine takeoff can be accomplished within the remaining available runway length, assuming a normal, dual-engine acceleration up to the time of engine failure. The minimum continuation speed is 70 KIAS based on directional control considerations. Effects of gross weight, takeoff index, runway length, flaps, wind, and slope are shown on the chart. Acceleration check speed must be acceptable before electing to continue takeoff on one engine.

WARNING

Continuation of the takeoff with an engine failure must include consideration of the gear down single-engine rate of climb at takeoff speed and configuration.

DIRECTIONS FOR USE OF CHART

Enter the chart with takeoff index, proceed up to the gross weight, across to the right to the runway length, and then drop down to the flap baseline. If flaps 7°, proceed down to the wind baselines; if flaps 0°, contour guidelines to zero and then down to wind baseline. Contour guidelines to required wind velocity and drop down to slope baseline (if zero wind condition, pass directly through guidelines). Contour guidelines to required runway slope and then drop down to read continuation speed scale in KIAS. (If no slope, drop through guidelines to speed scale.)

Sample Problem

Given:

- A. Takeoff index = 9.6
- B. Takeoff gross weight = 40,000 lb
- C. Available runway length = 6,000 ft
- D. Headwind component = 10 kt
- E. Runway slope = 1% uphill
- F. Flaps = 0°

Calculate:

A. Continuation speed for maximum thrust takeoff with flaps 0°.

B. Use continuation speed chart, figure A2-12

- | | |
|------------------|----------|
| 1. Takeoff index | 9.6 |
| 2. Runway length | 6,000 ft |

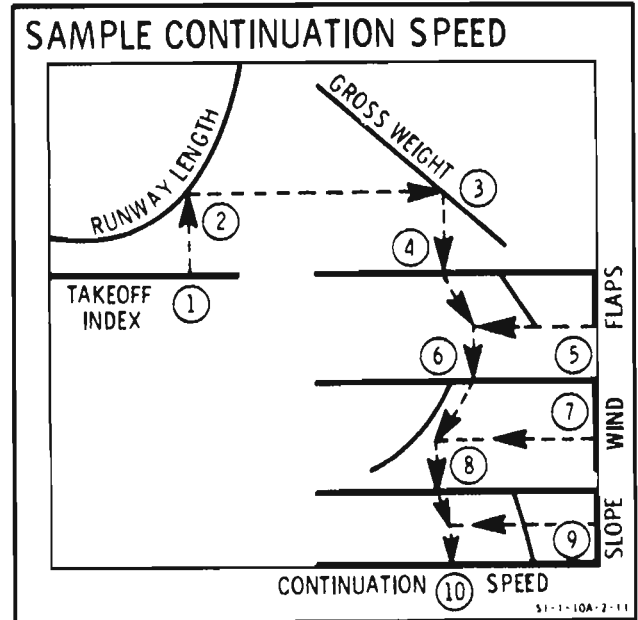

- | | |
|---|-----------|
| 3. Gross weight | 40,000 lb |
| 4. Go to flap baseline | |
| 5. Flaps | 0° |
| 6. Go to wind baseline (zero wind) | |
| 7. Headwind | 10 kt |
| 8. Go to runway slope baseline (zero slope) | |
| 9. Runway slope | 1% uphill |
| 10. Continuation speed | 120 KIAS |

WHEEL BRAKE ENERGY LIMIT SPEED CHART

The wheel brake energy limit speed chart is presented on figure A2-13 for speed brakes open 100% and speed brakes closed. In addition to speed brake position, the chart accounts for runway temperature, pressure altitude, and takeoff gross weight.

DIRECTIONS FOR USE OF CHART

To obtain the wheel brake energy limit speed, enter the chart with runway

temperature, and proceed horizontally to the right to pressure altitude, and then vertically down to the aircraft gross weight. From this point, proceed to the right to the speed brake position, and then vertically down to read the wheel brake energy limit speed. The wind correction is obtained from the note on the chart.

Sample Problem

Given:

- A. Runway temperature = 15 °C
- B. Pressure altitude = 1,000 ft
- C. Gross weight = 40,000 lb
- D. Speed brake position = open 100%
- E. Headwind component = 10 kt

Calculate:

- A. Wheel brake energy limit speed
- B. Use wheel brake energy limit speed chart, figure A2-13

- | | |
|---|-----------------------------------|
| 1. Runway temperature | 15 °C |
| 2. Pressure altitude | 1,000 ft |
| 3. Gross weight | 40,000 lb |
| 4. Speed brake position | open 100% |
| 5. Wheel brake energy limit speed (zero wind) | > 190 KIAS (no line intersection) |
| 6. Speed brake position | closed |
| 7. Wheel brake energy limit speed | 156 kts |

Correction for headwind +10 kts

Corrected wheel brake energy limit speed = 166 kts (with speed brakes closed)

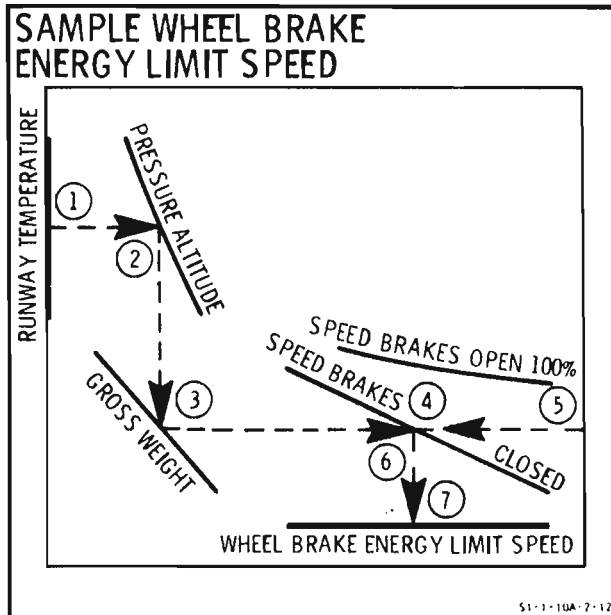

ACCELERATION CHECK SPEED CHART

The acceleration check speed chart is presented on figure A2-14 for flaps 7° with maximum or 3% below PTFS. An acceleration check is made during the takeoff ground run to assure proper acceleration. The check is made between brake release and speed at the end of a specified time/distance. The speed at the acceleration check is shown on this chart. It should be noted that the refusal speed must be greater than the check speed. The acceleration check speed tolerance is defined as the refusal speed minus the continuation speed, or 10 knots, whichever is less. If the acceleration check speeds at the runway markers or at the time check intervals are not achieved within the acceleration check speed tolerance, a system malfunction is indicated and the takeoff should be aborted.

DIRECTIONS FOR USE OF CHART

Enter the chart with takeoff index, proceed up to gross weight, and then horizontally to the desired time interval. From this point, project vertically down to the wind baseline, contour the guidelines to the wind velocity, and then down to the runway slope baseline. Contour the guidelines to the runway slope and finally project down to read the acceleration check speed. For zero wind and zero

runway slope conditions, proceed through the corrections grids to the acceleration check speed scale.

Sample Problem

Given:

- A. Takeoff flap setting = 7°
- B. Takeoff index = 9.6
- C. Gross weight = 40,000 lb
- D. Acceleration check time = 15 sec
- E. Headwind = 10 kt
- F. Runway slope = 1% uphill

Calculate:

A. Acceleration check speed for maximum thrust takeoff

B. Use acceleration check speed chart, figure A2-14

- 1. Takeoff index 9.6
- 2. Gross weight 40,000 lb
- 3. Acceleration check time 15 sec
- 4. Go to wind baseline
- 5. Headwind 10 kt
- 6. Go to runway slope baseline
- 7. Runway slope 1% uphill
- 8. Acceleration check speed 98 KIAS

C. Acceleration check speed tolerance

- 1. Refusal speed 128 KIAS

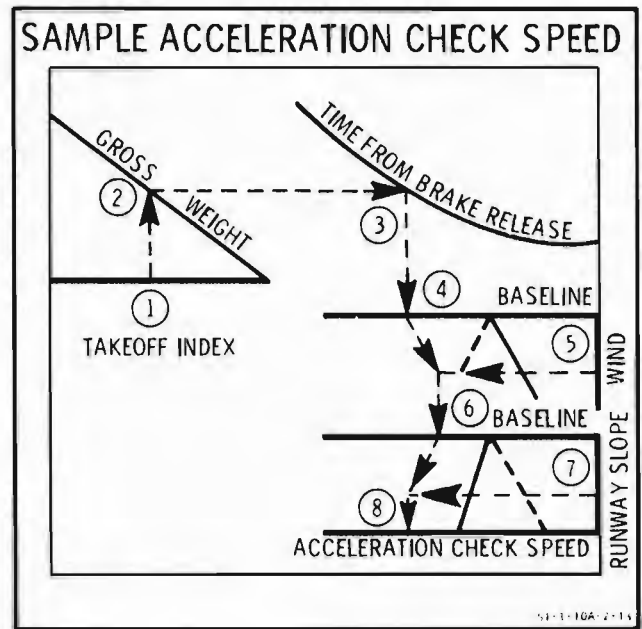

- 2. Continuation speed 120 KIAS
- 3. Acceleration check speed tolerance 8 KIAS

RUNWAY WIND COMPONENTS CHART

The runway wind components chart, presented on figure A2-15, provides the means of converting surface wind velocities into components parallel to and across the runway. The headwind or tailwind component is used to compute takeoff and landing distances, and the crosswind component is used to determine the feasibility of operations.

DIRECTIONS FOR USE OF CHART

Enter the chart at wind velocity and angle relative to the active runway, project to the left to read the runway wind component (headwind or tailwind), and down to read the crosswind component.

Sample Problem

Given:

- A. Relative wind direction = 030°
- B. Relative wind velocity = 25 kt

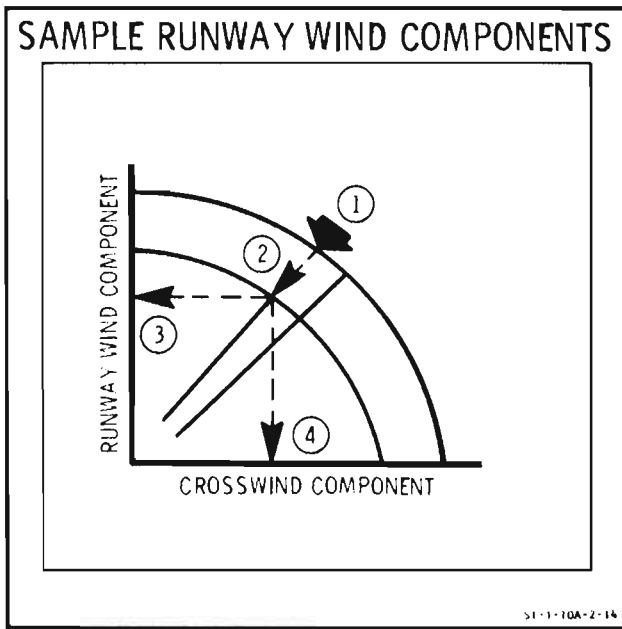

Calculate:

- A. Headwind and crosswind components
1. Relative wind direction 030°
 2. Relative wind velocity 25 kt
 3. Runway wind component 25 kt headwind
 4. Crosswind component 12.5 kt

ABORT TAKEOFF CHARTS (GENERAL)

The abort takeoff charts contained on figures A2-2 through A2-15 provide the means of planning for a GO/NO-GO decision if an engine fails during takeoff. This discussion of the GO/NO-GO concept illustrates the factors that influence the decision to stop or go if an engine fails. The principal factor affecting an aborted takeoff is the relationship of actual runway length to critical field length, which falls into two categories; within each category, the speed at which the engine fails further affects the stop or go decision. The decision to continue the takeoff must always include consideration of the gear down single-engine climb capability at takeoff speed under the existing conditions.

Category 1: Runway length is greater than or equal to critical field length (or continuation speed is less than or equal to refusal speed).

a. If engine failure occurs before continuation speed is reached, the takeoff should be aborted; there will not be enough runway available to accelerate (with one engine operating) to takeoff speed.

b. If an engine fails or if subnormal acceleration is experienced before refusal speed is reached, there is sufficient runway length to stop, and the takeoff should be aborted.

c. If an engine fails at a speed higher than refusal speed, a single-engine takeoff can be accomplished within the remaining runway length, provided the aircraft has a positive gear down single-engine rate of climb at takeoff speed.

Category 2: Runway length is less than critical field length (or continuation speed is greater than refusal speed).

Under these conditions, if an engine fails between refusal speed and continuation speed, the runway length is not sufficient to either stop or complete a single-engine takeoff.

FAN SPEED REQUIRED FOR PREDICTED TAKEOFF PERFORMANCE

Figure A2-16 provides the fan speed required at ambient temperature to obtain the thrust required for the following performance figures: Single-Engine Rate of Climb (Figure A2-3), Takeoff Ground Run (Figure A2-5 and A2-6), 50 Ft. Obstacle Clearance Distance Maximum Thrust (Figure A2-7), Critical Field Length (Figure A2-10), Refusal Speed (Figure A2-11), Continuation Speed (Figure A2-12), and Acceleration Check Speed (Figure A2-14). After computing and recording takeoff data, use Figure A2-16 to find the fan speed required to provide the predicted takeoff performance previously computed.

MINIMUM FAN SPEEDS REQUIRED FOR DESIRED SINGLE-ENGINE RATES-OF-CLIMB

Minimum fan speeds required for desired single-engine rates-of-climb are presented on figures A2-17 (Sheets 1 of 2 and 2 of 2) for landing gear down and figures A2-18 (Sheets 1 of 2 and 2 of 2) for landing gear up. These data are based on normal takeoff airspeed with one engine operating at maximum thrust, and the other engine failed and windmilling. The charts present the minimum required fan speed with flaps 7°, landing gear down (or up) as a function of outside air temperature, pressure altitude, gross weight, drag index, and desired single-engine rate-of-climb at takeoff airspeed. The minimum required fan speeds with flaps retracted (0°) during takeoff are presented on figure A2-19 as a function of the fan speeds required with flaps 7° as obtained from figures A2-17 and/or A2-18. The minimum required fan speeds which result from delaying takeoff until the best single-engine rate-of-climb airspeed is achieved, are presented on figure A2-20.

Sample Problem.

Given:

- A. Flaps = 7°
- B. Landing gear = Down
- C. Runway temperature = 30°C (86°F)
- D. Pressure altitude = Sea level
- E. Gross weight = 40,000 lb.
- F. Drag index = 0
- G. Desired single-engine rate-of-climb at takeoff airspeed = 100 FPM

Calculate:

- A. Minimum Fan Speed required for 100 FPM rate-of-climb at normal takeoff airspeed, flaps 7°, and landing gear down.
- B. Use Minimum Required Fan Speed chart, figure A2-17 (Sheet 1 of 2).

- | | |
|-----------------------|-----------|
| 1. Runway temperature | 30°C |
| 2. Pressure altitude | Sea level |
| 3. Gross weight | 40,000 lb |
| 4. Fan Speed | 79.5% RPM |

(This fan speed scale is used only as a transfer scale to go from figure A2-17 (Sheet 1 of 2) to figure A2-17 (Sheet 2 of 2))

- C. Use Minimum Required Fan Speed chart, figure A2-17 (Sheet 2 of 2).

- | | |
|--|-----------|
| 5. Fan speed
(from fig. A2-17
Sheet 1 of 2) | 79.5% RPM |
| 6. Drag index | 0 |
| 7. Desired single-engine
rate-of-climb at
takeoff airspeed | 100 FPM |
| 8. Minimum required
fanspeed | 81% RPM |

Using figures A2-18 (Sheets 1 of 2 and 2 of 2) in a similar manner, the resulting minimum fan speed required for a 100 FPM single-engine rate-of-climb at takeoff airspeed with gear up is 75.9% RPM.

If takeoff is to be performed with flaps 0°, the minimum fan speeds required for a 100 FPM single-engine rate-of-climb at takeoff airspeed would be obtained from figure A2-19 as follows:

- | | |
|--|-----------|
| 1. Required fan speed, flaps
7°, gear down
(from Figure A2-17) | 81% RPM |
| 2. Gear Down reflector | - |
| 3. Required fan speed, flaps
0°, gear down | 79.2% RPM |
| and | |
| 4. Required fan speed, flaps
7°, gear up
(from Figure A2-18) | 75.9% RPM |
| 5. Gear Up reflector | - |
| 6. Required fan speed, flaps
0°, gear up | 73.6% RPM |

If takeoff is delayed until the best single-engine rate-of-climb airspeed is achieved, the minimum required fan speeds would be obtained by using figure A2-20 as follows:

- | | |
|---|-----------|
| 1. Fan speed required for R/C
at T.O. speed, flaps 7°,
gear down
(from Figure A2-17) | 81% RPM |
| 2. Gear Down reflector | - |
| 3. Fan speed required at best
R/C speed, flaps 7°,
gear down | 80.2 RPM |
| and | |
| 4. Fan speed required for R/C
at T.O. speed, flaps 0°,
gear down | 79.2% RPM |
| 5. Gear Down reflector | |

6. Fan speed required at best R/C speed, flaps 0°, gear down 78.5% RPM

TAKEOFF/ABORT CRITERIA

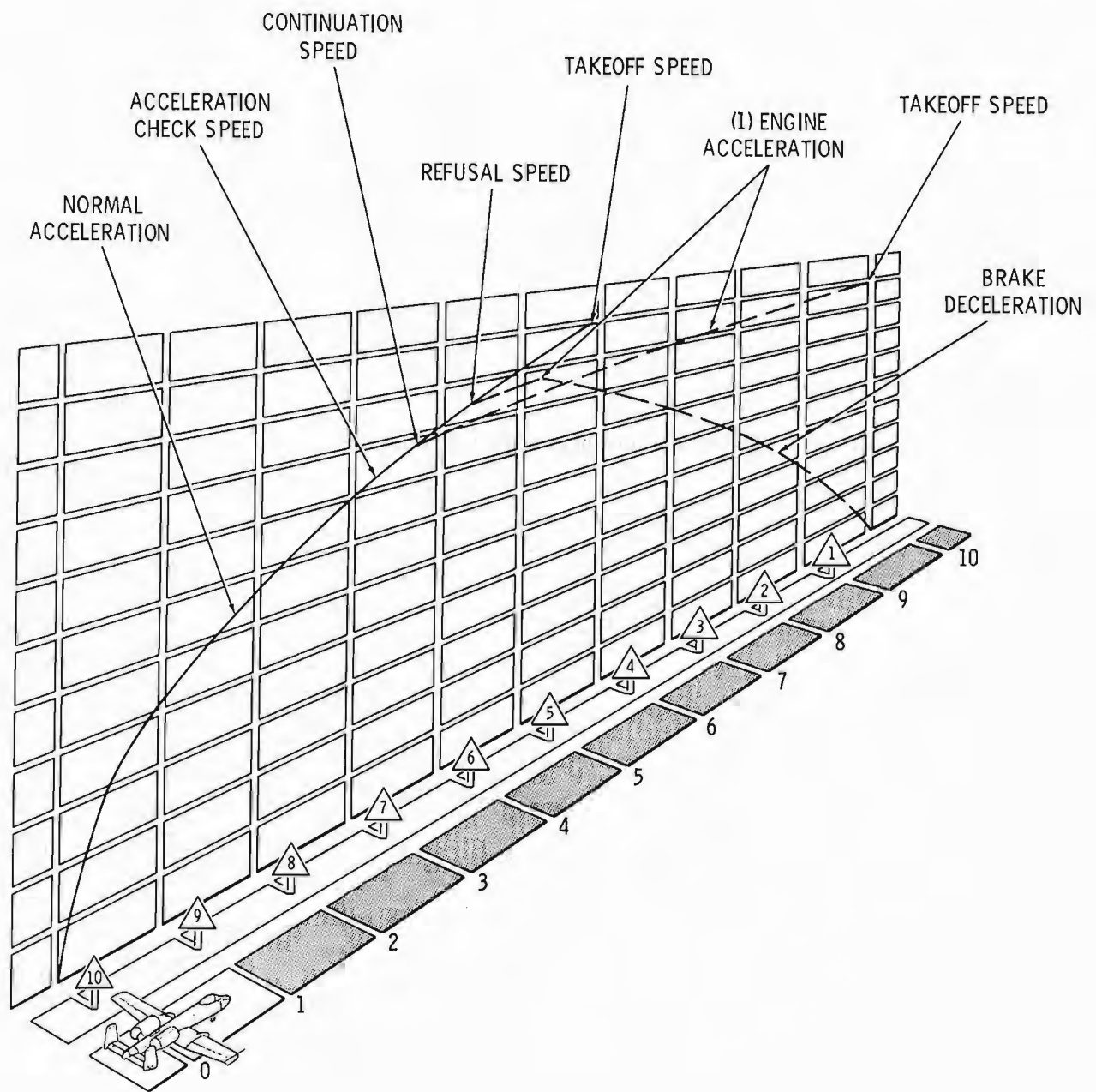

1-1-10A-2-15

Figure A2-1

This page intentionally left blank

MODEL : A-10A
 DATE : 30 NOVEMBER 1982
 DATA BASIS : A . F. FLIGHT TEST
 ENGINES : (2) TF34-GE-100/-100A

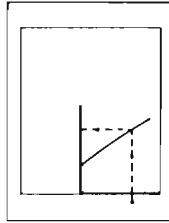

ROTATION and TAKEOFF SPEED
Max. or 3% Below Predicted Fan Speed



WARNING

- Takeoff distances for unimproved surfaces will be significantly increased and have not been substantiated by flight tests.

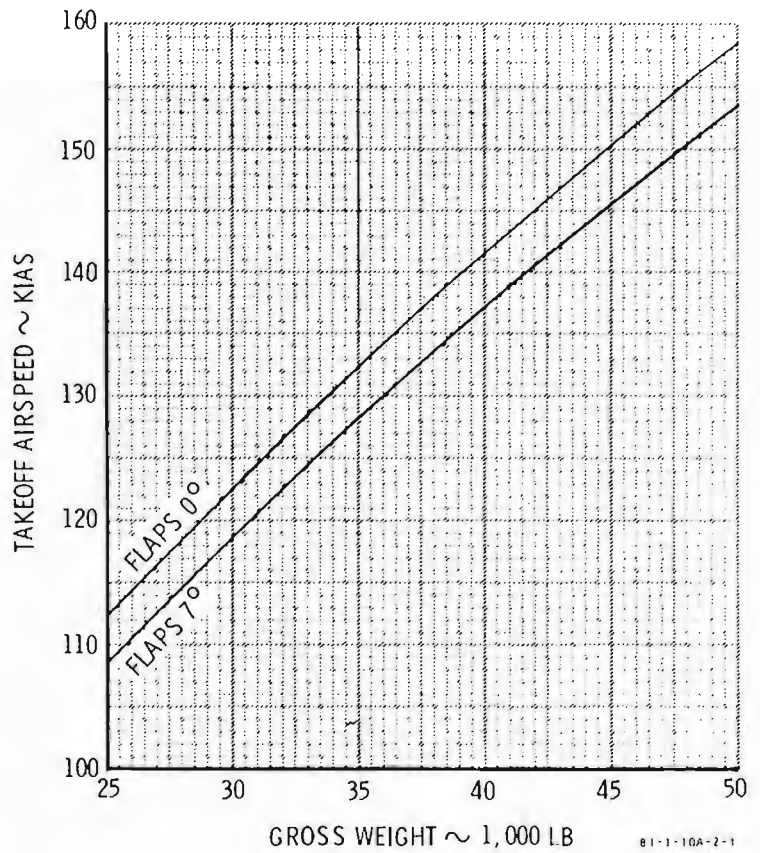
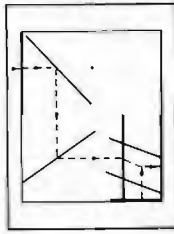

Figure A2-2

**SINGLE-ENGINE
RATE of CLIMB
Flaps 7°, Gear Down
Maximum Thrust
At Takeoff Speed**



MODEL : A-10A
DATE : 30 NOVEMBER 1982
DATA BASIS : A . F . FLIGHT TEST
ENGINES : (2) TF34-GE-100/-100A

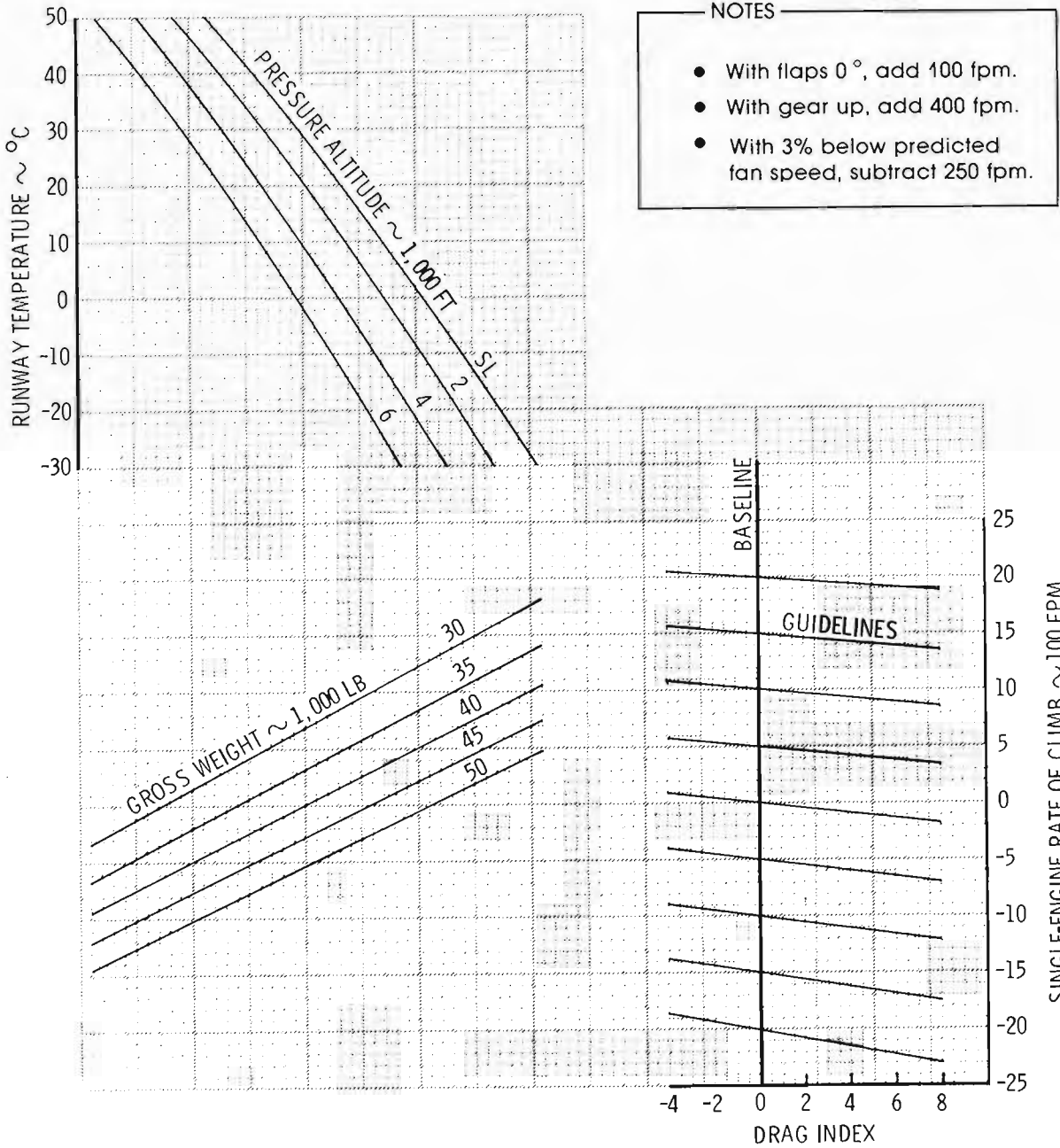
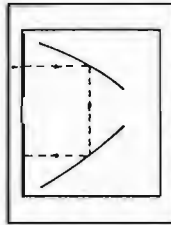

Figure A2-3

MODEL : A-10A
 DATE : 30 NOVEMBER 1982
 DATA BASIS : A . F . FLIGHT TEST
 ENGINES : (2) TF34-GE-100/-100A



TAKEOFF INDEX
 Max. or 3% Below Predicted
 Fan Speed

WARNING

- Takeoff distances for unimproved surfaces will be significantly increased and have not been substantiated by flight tests.

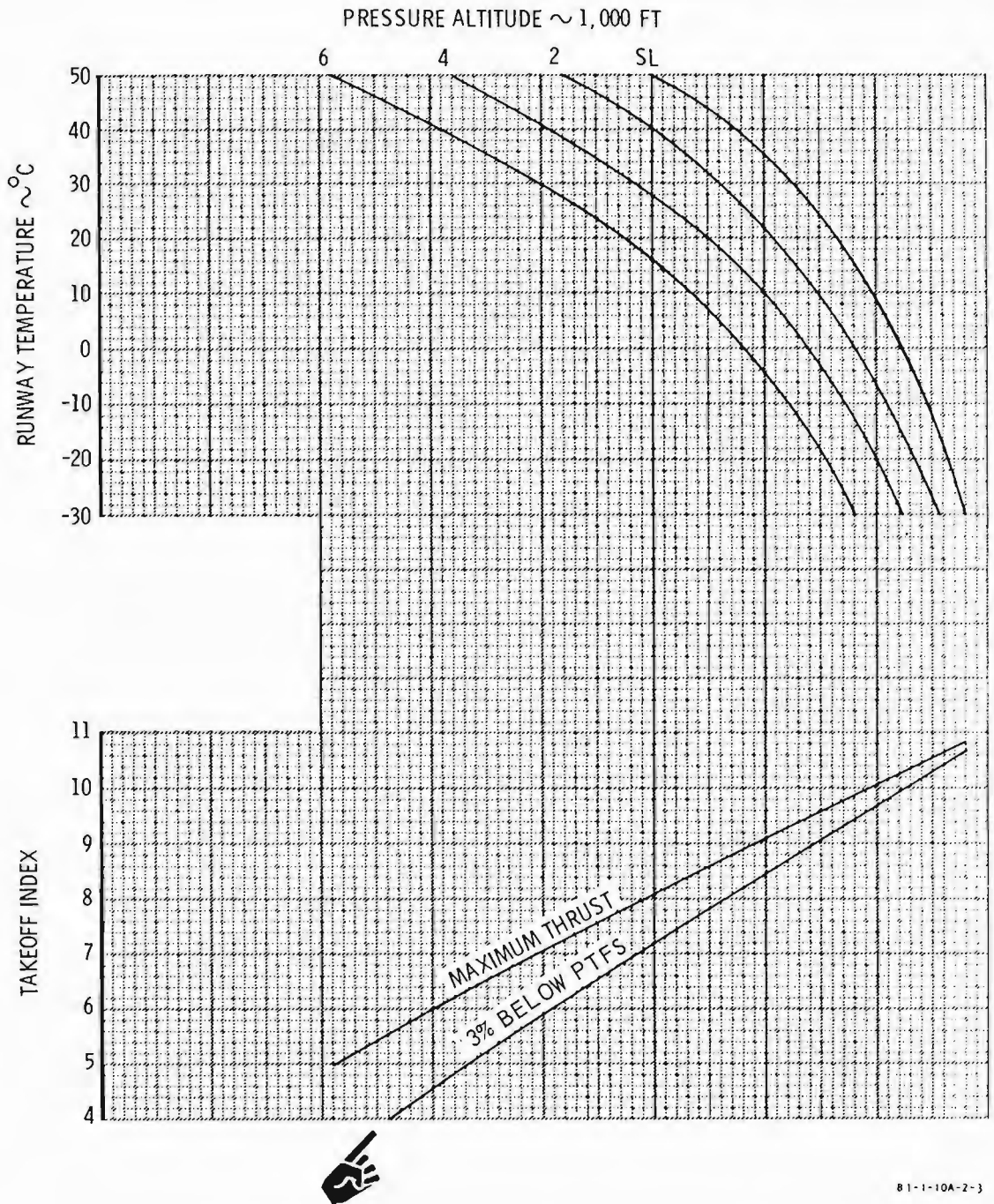

81-1-10A-2-3

Figure A2-4

TAKEOFF GROUND RUN
Flaps 0°
Max. or 3% Below Predicted
Fan Speed

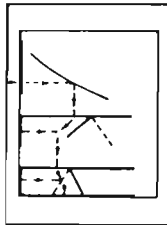

MODEL : A-10A
 DATE : 30 NOVEMBER 1982
 DATA BASIS : A.F. FLIGHT TEST
 ENGINES : (2) TF34-GE-100/-100A

WARNING

• Takeoff distances for unimproved surfaces will be significantly increased and have not been substantiated by flight tests.

NOTE

If best single-engine rate-of-climb is used as takeoff speed, increase ground run by 25%

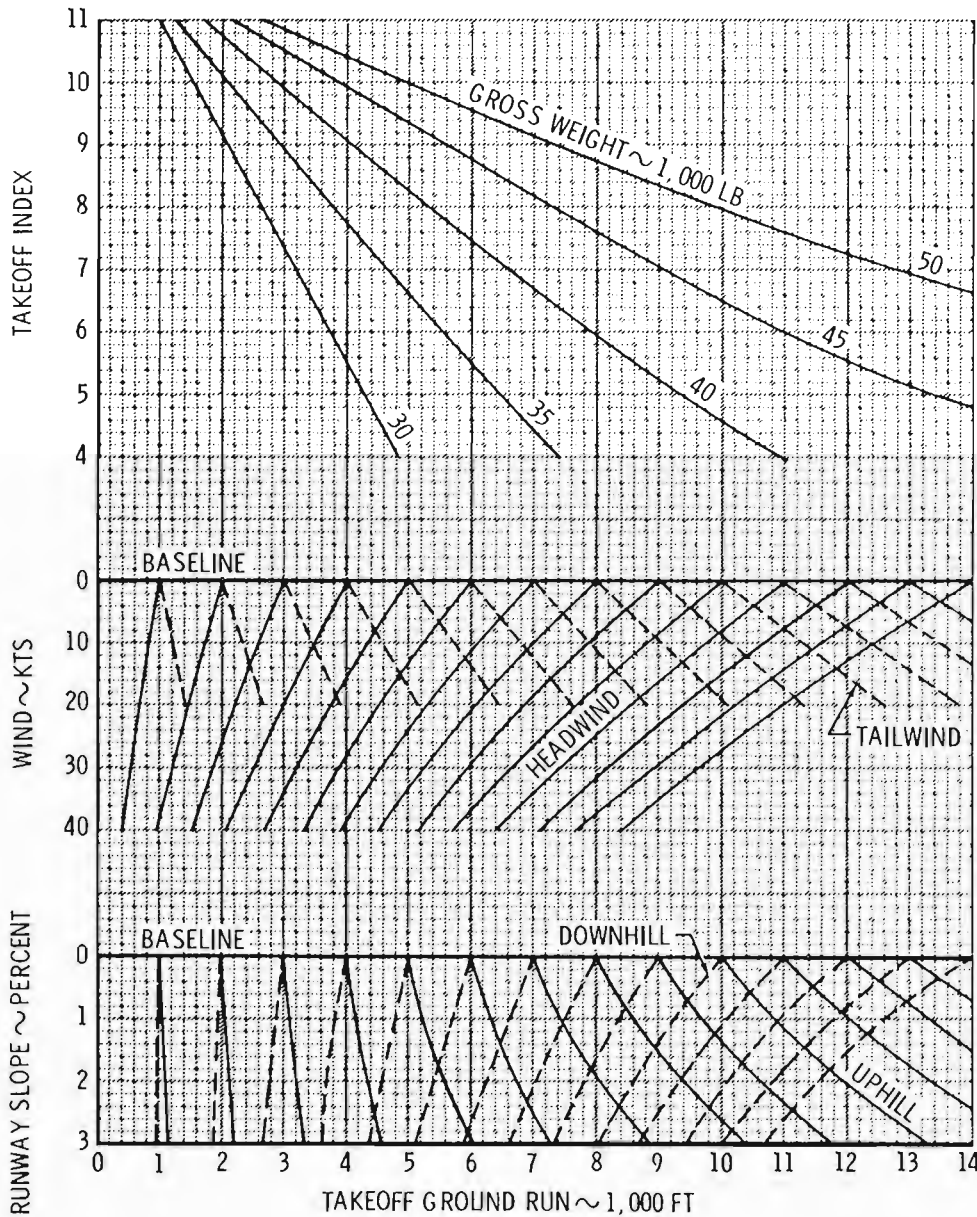

B1-1-10A-2-4

Figure A2-5

MODEL : A-10A
 DATE : 30 NOVEMBER 1982
 DATA BASIS : A . F . FLIGHT TEST
 ENGINES : (2) TF34-GE-100/-100A

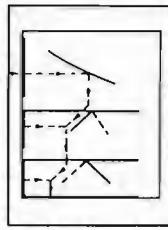

TAKEOFF GROUND RUN
 Flaps 7°
 Max. or 3% Below Predicted
 Fan Speed

NOTE
 If best single-engine rate-of-climb is used as takeoff speed, increase ground run by 18%.

WARNING
 • Takeoff distances for unimproved surfaces will be significantly increased and have not been substantiated by flight tests.

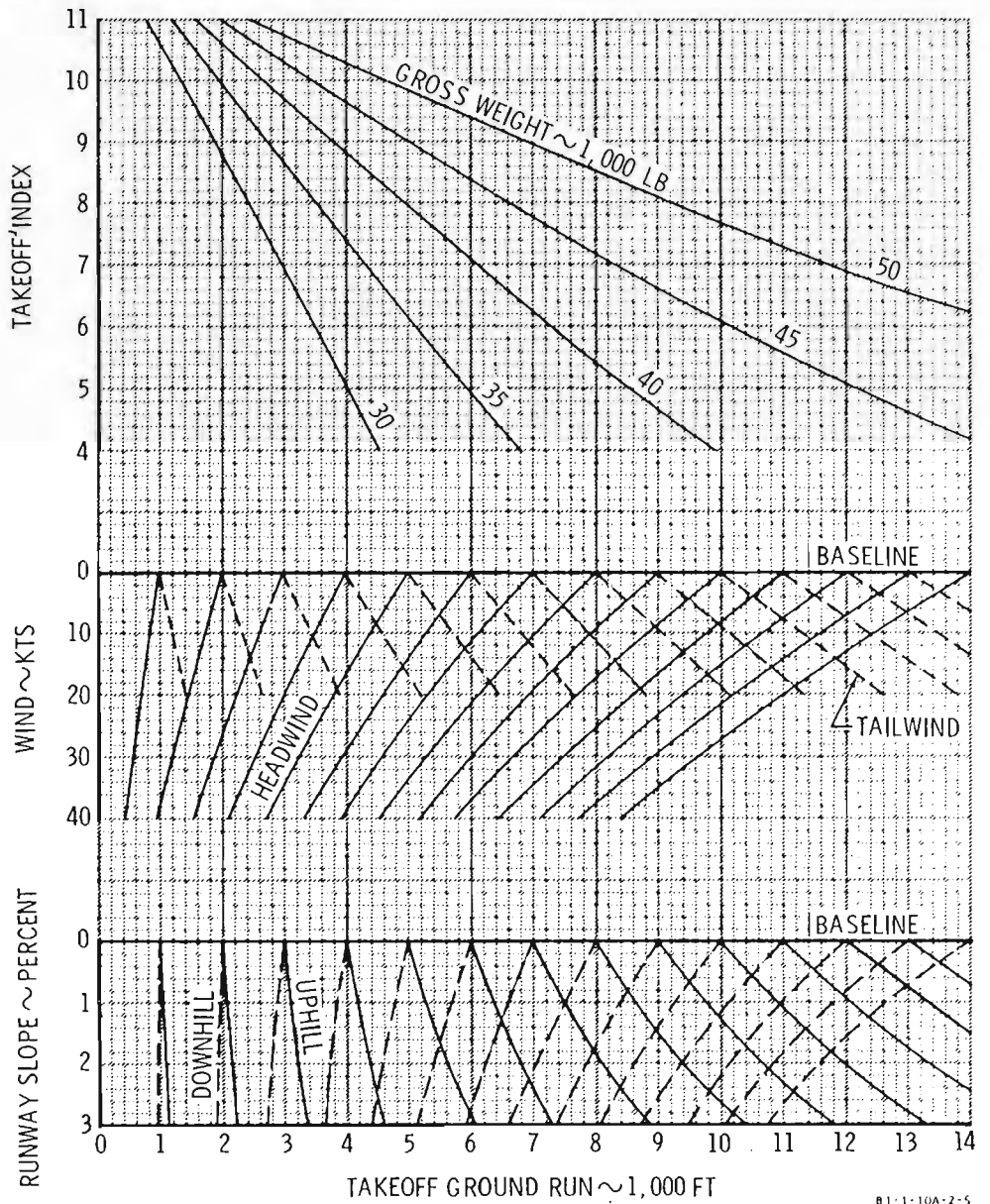

B1-1-10A-2-5

Figure A2-6

**50 FT. OBSTACLE
CLEARANCE DISTANCE
Maximum Thrust**

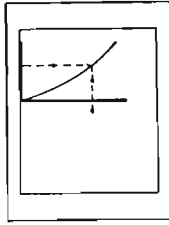

MODEL : A-10A
 DATE : 30 NOVEMBER 1982
 DATA BASIS : **A.F. FLIGHT TEST**
 ENGINES : (2) TF34-GE-100/-100A

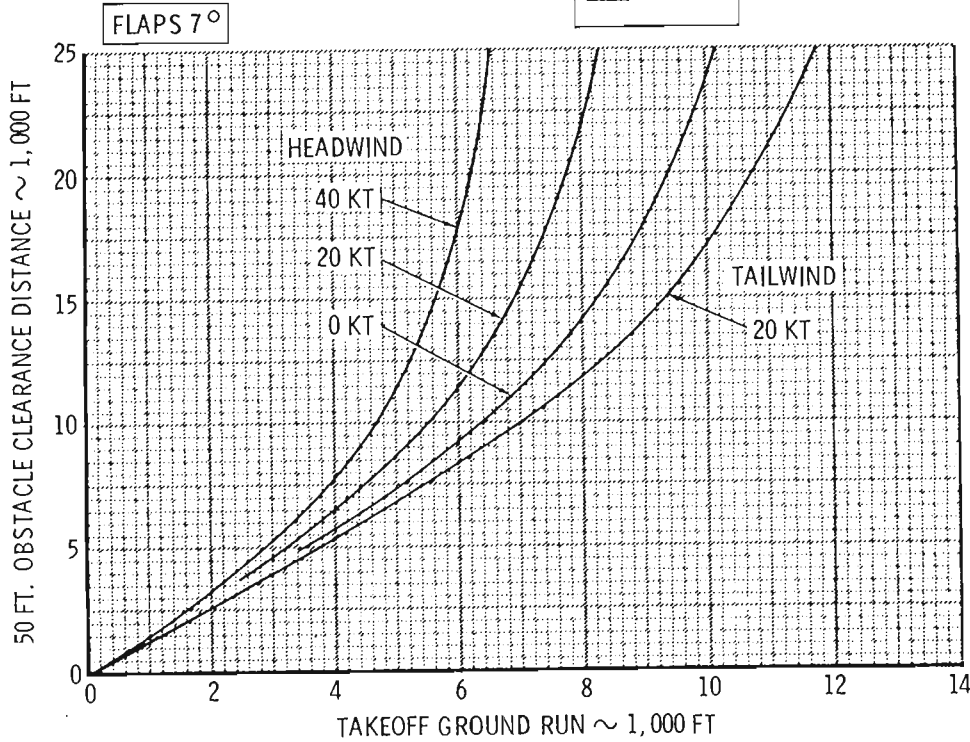

WARNING

- Takeoff distances for unimproved surfaces will be significantly increased and have not been substantiated by flight tests.



NOTE

If best single-engine rate-of-climb speed is used as takeoff speed, increase 50ft obstacle clearance distance by 17% with flaps 7°.

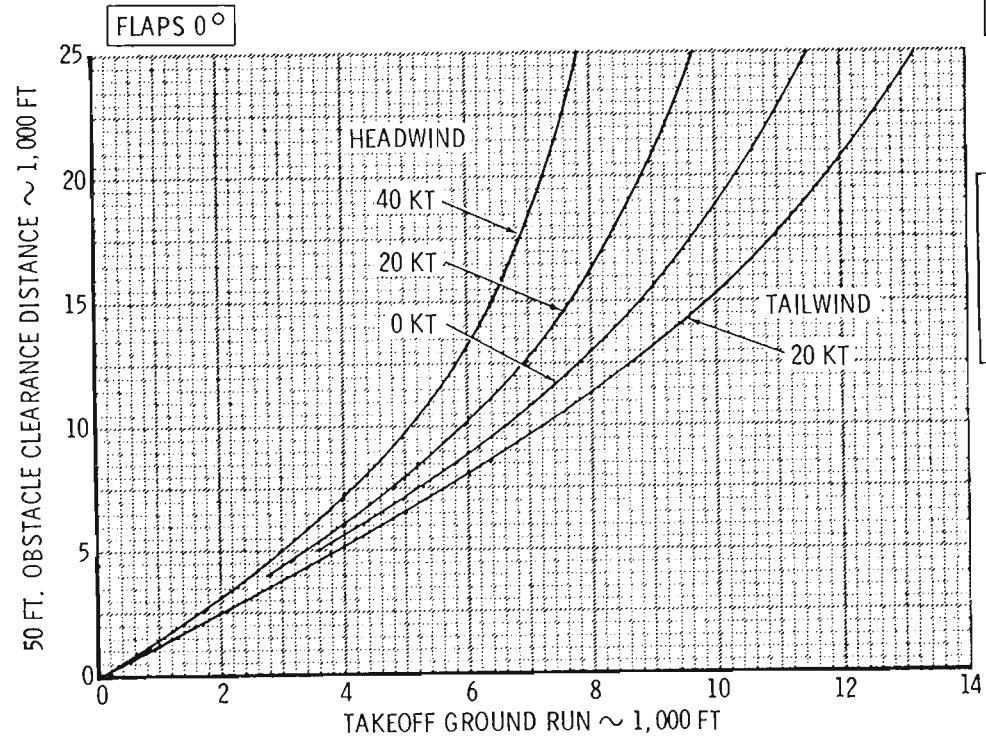

NOTE

If best single-engine rate-of-climb speed is used as takeoff speed, increase 50ft obstacle clearance distance by 25% with flaps 0°.

81-1-10A-2-6

Figure A2-7

MODEL : A-10A
 DATE : 30 NOVEMBER 1982
 DATA BASIS : A.F. FLIGHT TEST
 ENGINES : (2) TF34-GE-100/100A

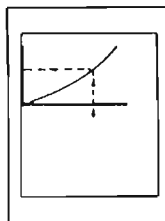

**50 FT. OBSTACLE
 CLEARANCE DISTANCE
 3% Below Predicted Fan Speed**

WARNING

- Takeoff distances for unimproved surfaces will be significantly increased and have not been substantiated by flight tests.



NOTE

- If best single-engine rate-of-climb speed is used as takeoff speed, increase 50ft obstacle clearance distance by 17% with flaps 7°.

NOTES

- If best single-engine rate-of-climb speed is used as takeoff speed, increase 50ft obstacle clearance distance by 25% with flaps 0°.

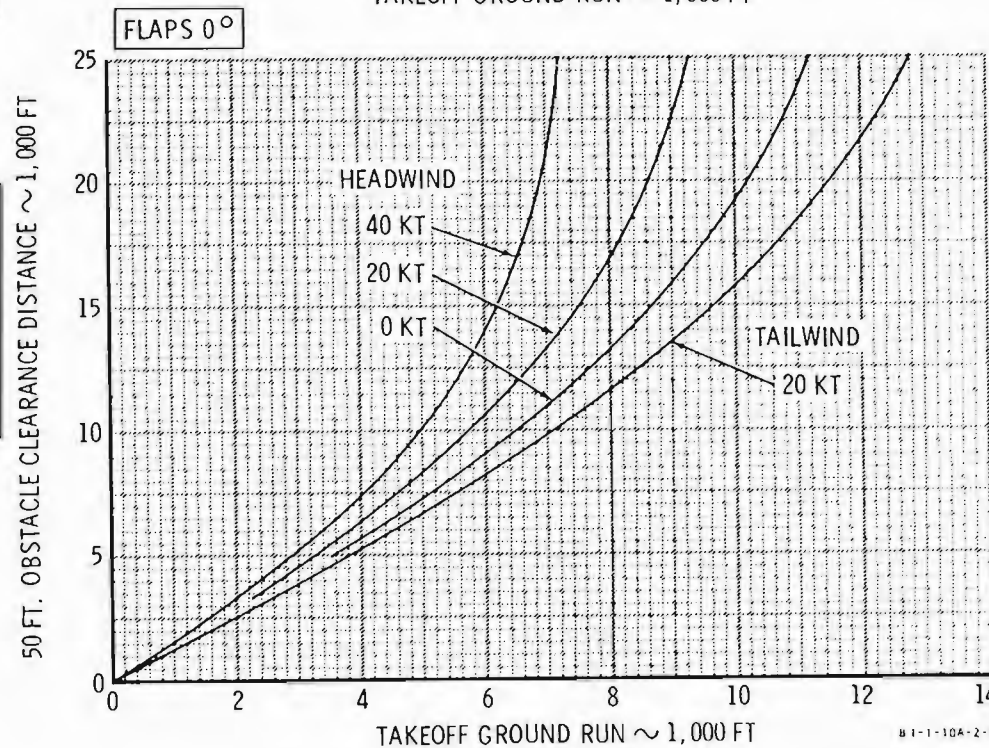
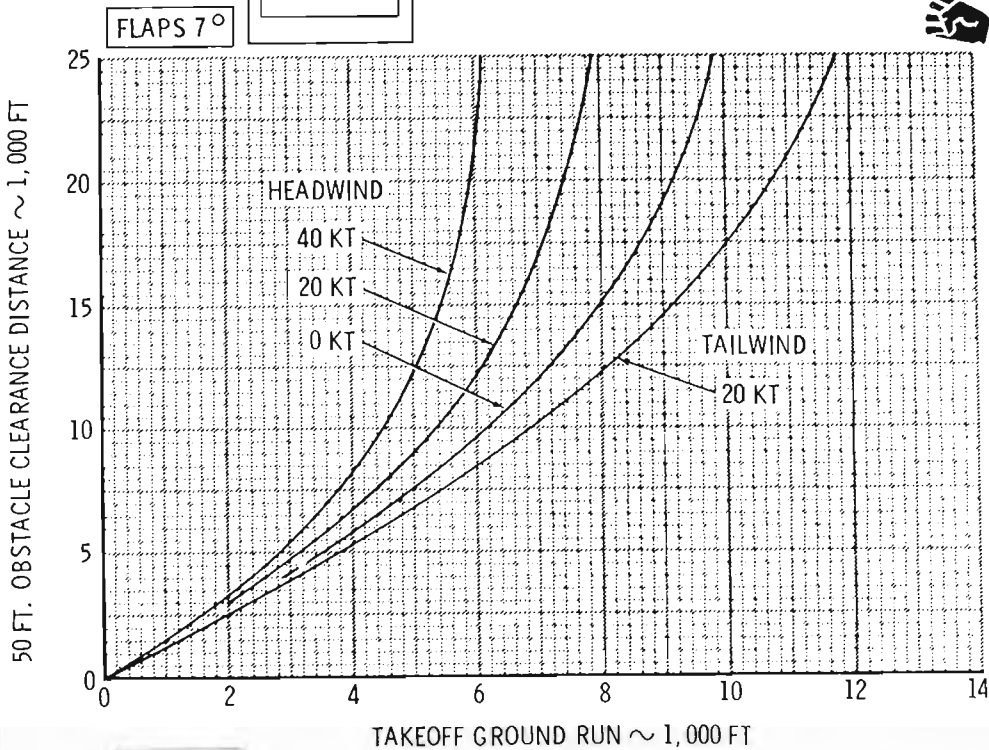

1-1-10A-2-7

Figure A2-8

**RCR Without
ANTI-SKID**

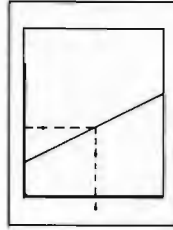

MODEL : A-10A
 DATE : 30 NOVEMBER 1982
 DATA BASIS : **A . F . FLIGHT TEST**
 ENGINES : (2) TF34-GE-100/-100A



RCR	CONDITION
23	DRY
12	WET
5	ICY

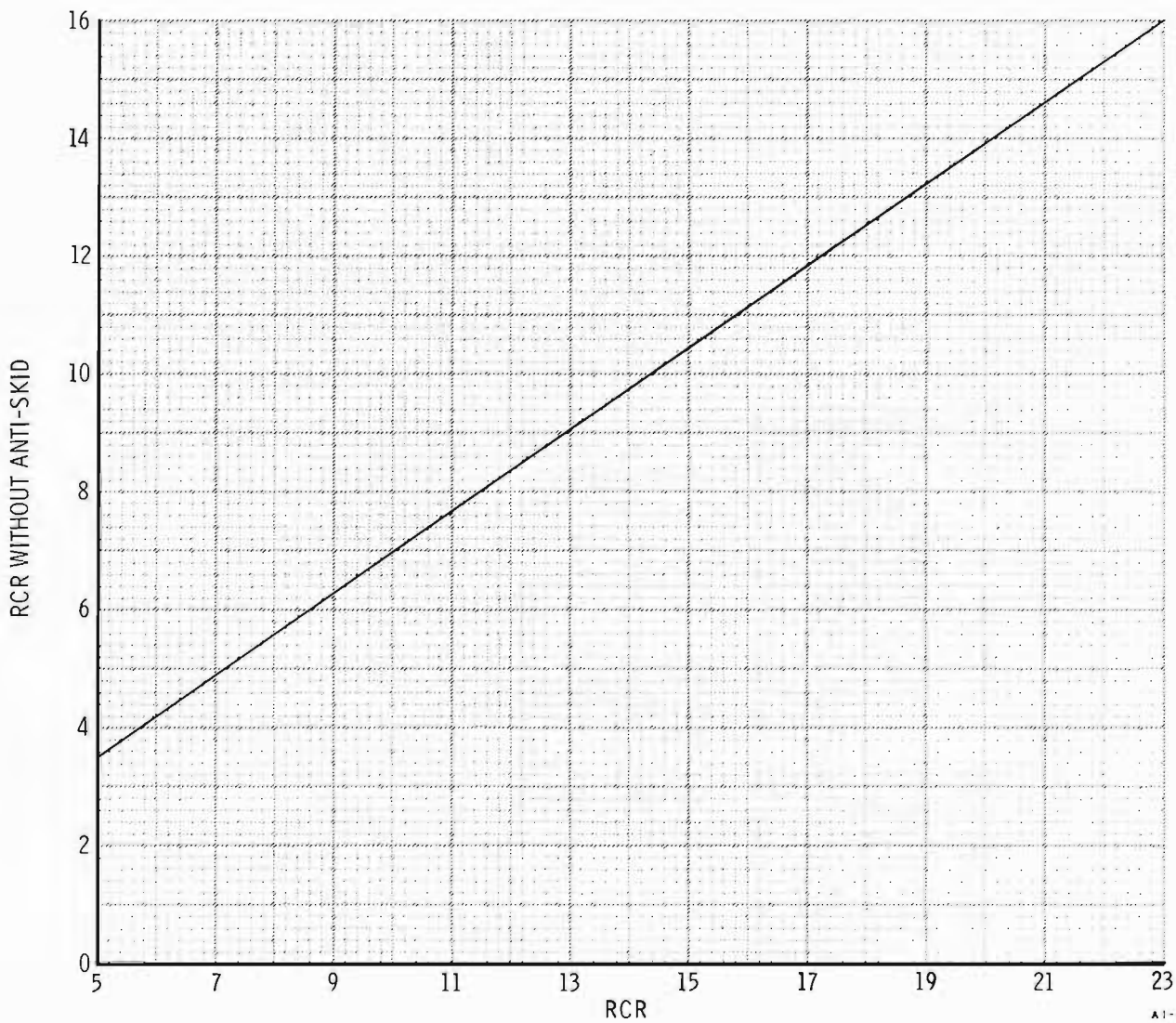

A1-1-10A-2-8

Figure A2-9

MODEL : A-10A
 DATE : 30 NOVEMBER 1982
 DATA BASIS : A . F . FLIGHT TEST
 ENGINES : (2) TF34-GE-100/-100A

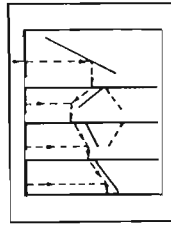

CRITICAL FIELD LENGTH
Flaps 7°
Speed Brakes Open 100%

WARNING

- Critical field lengths obtained for RCR's less than 12 are estimated and have not been substantiated by flight test data.
- Takeoff distances for unimproved surfaces will be significantly increased and have not been substantiated by flight tests.

NOTES

- With flaps 0°, increase distance by 7%.
- With speed brakes closed, increase distance by 7%.
- If best single-engine rate-of-climb speed is used as takeoff speed, increase critical field length by 16% with flaps 7° and 22% with flaps 0°.

RCR	CONDITION
23	DRY
12	WET
5	ICY

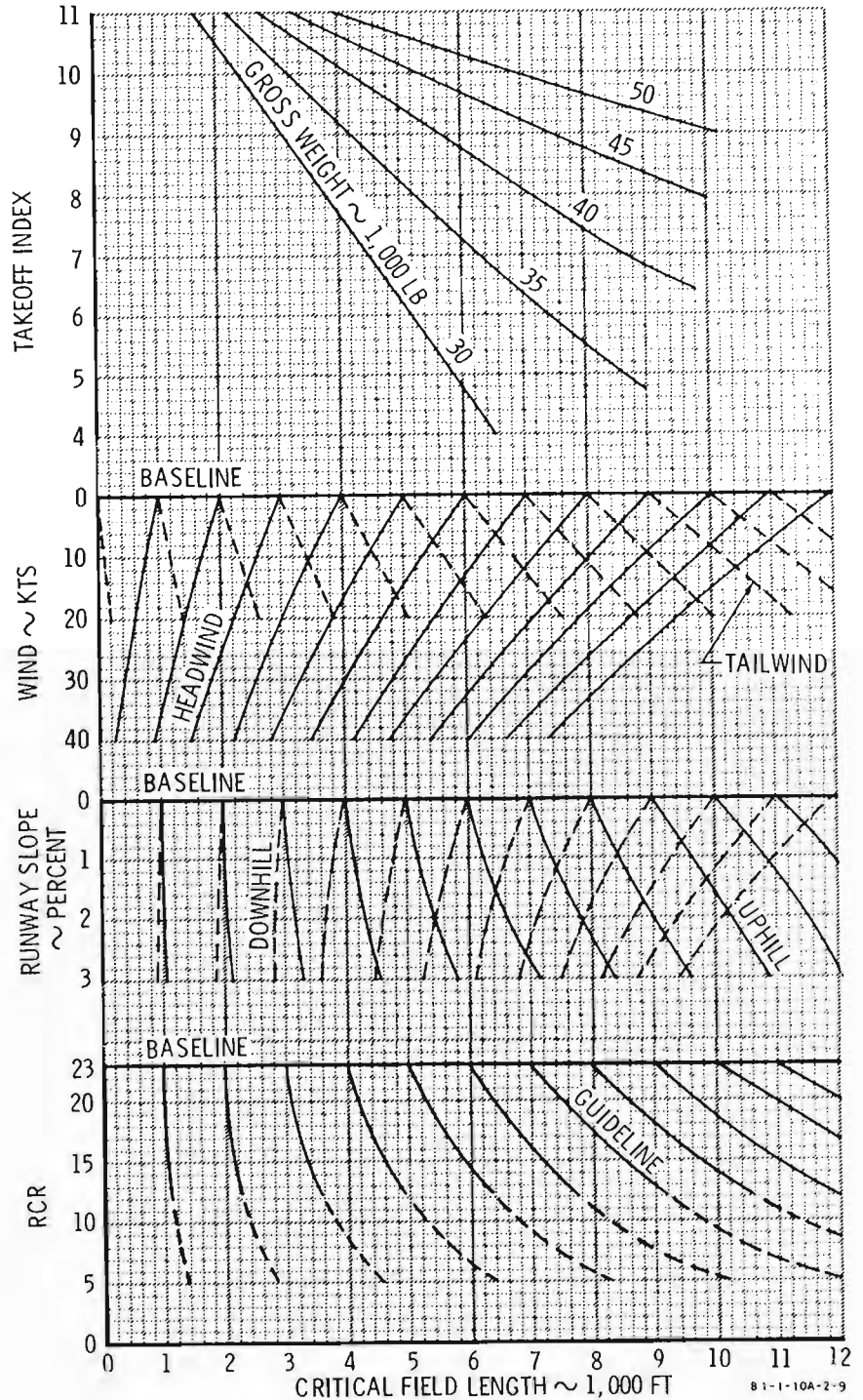
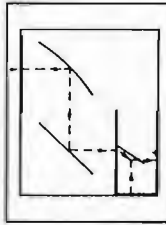

Figure A2-10

REFUSAL SPEED

Flaps 0° or 7°

Max. or 3% Below Predicted
Fan Speed
Speed Brakes Open 100%



MODEL : A-10A
DATE : 30 NOVEMBER 1982
DATA BASIS : A . F . FLIGHT TEST
ENGINES : (2) TF34-GE-100/-100A

WARNING

- Refusal speeds obtained for RCR's less than 12 are estimated and have not been substantiated by flight test data.
- Takeoff distances for unimproved surfaces will be significantly increased and have not been substantiated by flight tests.

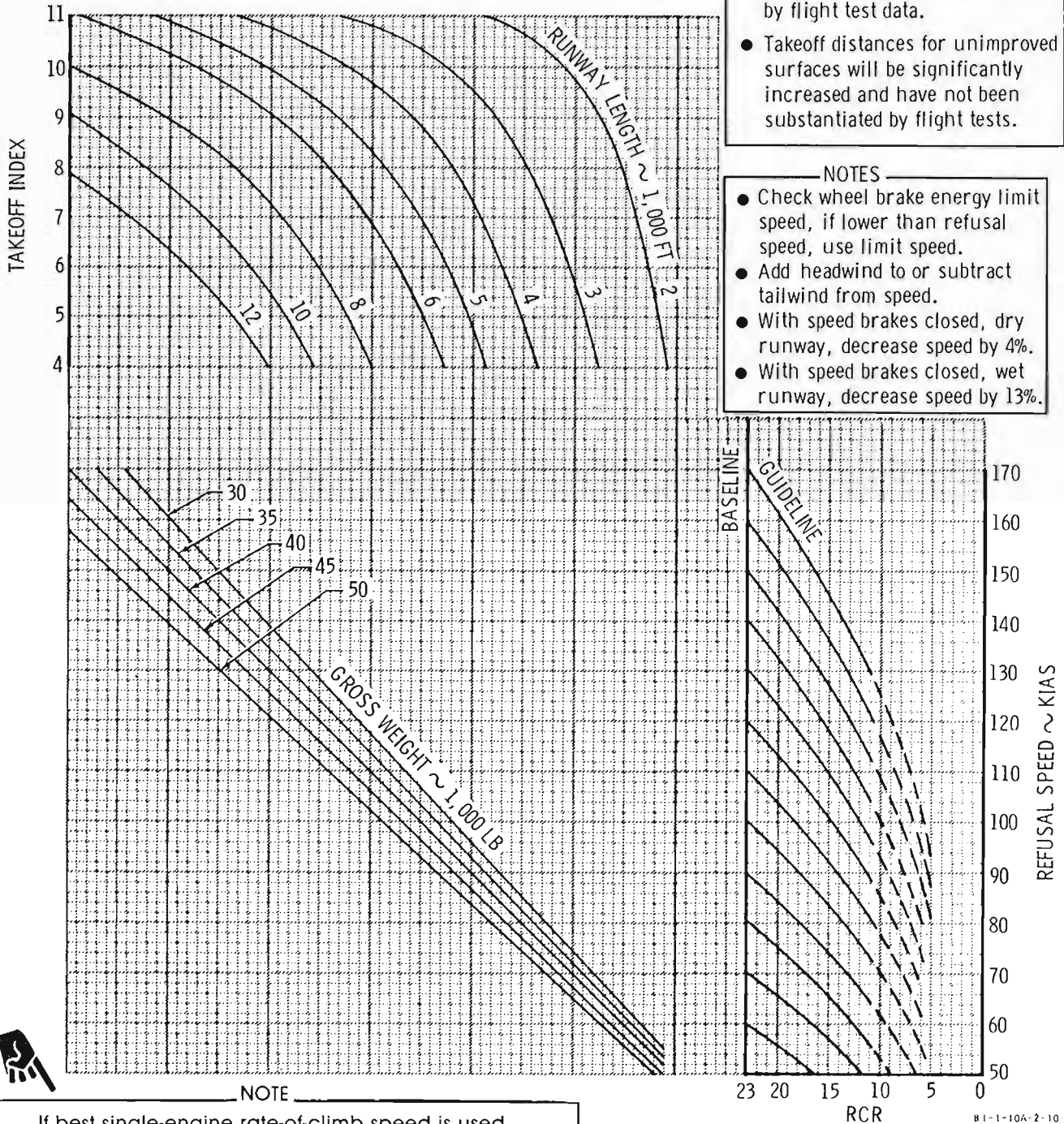

- NOTES
- Check wheel brake energy limit speed, if lower than refusal speed, use limit speed.
 - Add headwind to or subtract tailwind from speed.
 - With speed brakes closed, dry runway, decrease speed by 4%.
 - With speed brakes closed, wet runway, decrease speed by 13%.

NOTE
If best single-engine rate-of-climb speed is used
as takeoff speed, refusal speed remains unchanged.

Figure A2-11

THIS PAGE INTENTIONALLY LEFT BLANK

MODEL : A-10A
 DATE : 30 NOVEMBER 1982
 DATA BASIS : A . F . FLIGHT TEST
 ENGINES : (2) TF34-GE-100/-100A

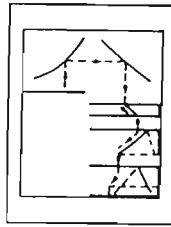

CONTINUATION SPEED

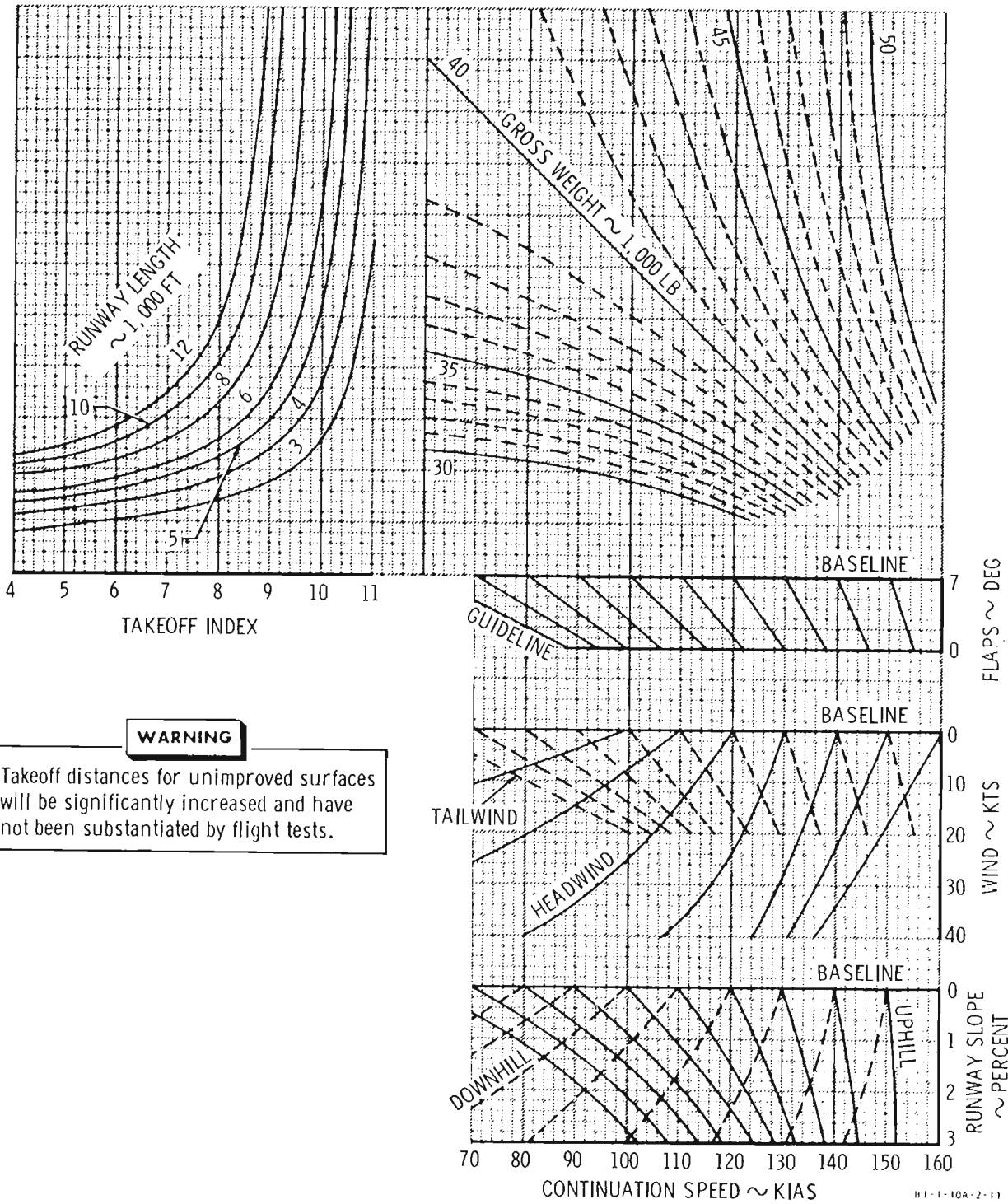

11-1-10A-2-11

Figure A2 - 12

MODEL: A-10A
 DATE: 27 APRIL 1987
 DATA BASIS: A. F. FLIGHT TEST

ENGINES: (2) TF34-GE-100/100A
 FUEL GRADE: JP-4
 FUEL DENSITY: 6.5 LB/US GAL

CONTINUATION SPEED
 • Best S.E. R/C Speed
 used as Takeoff Speed

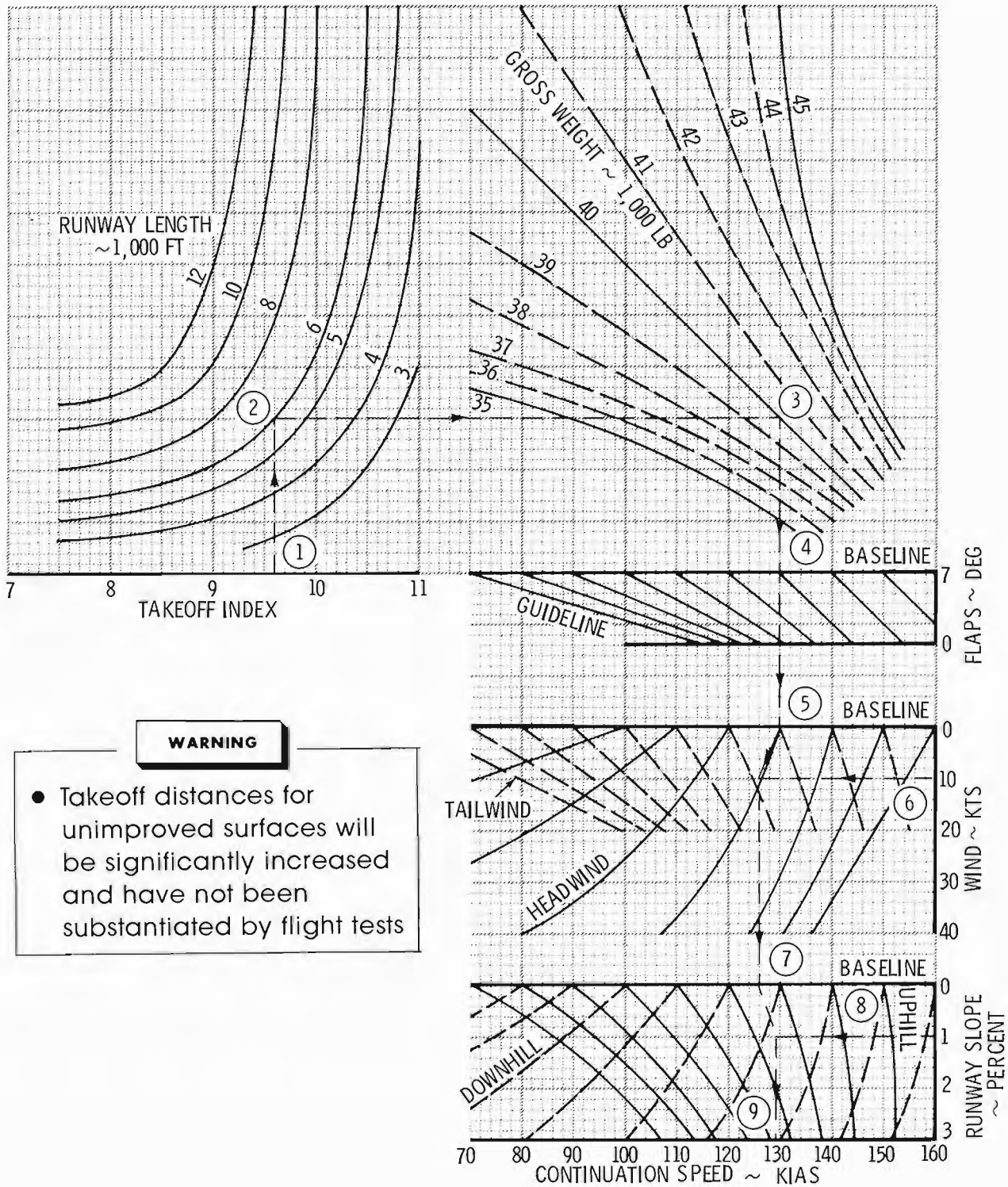

WARNING

- Takeoff distances for unimproved surfaces will be significantly increased and have not been substantiated by flight tests

Figure A2 - 12A

**WHEEL BRAKE ENERGY
LIMIT SPEED**

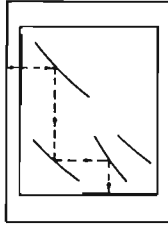

MODEL : A-10A
 DATE : 30 NOVEMBER 1982
 DATA BASIS : **A . F . FLIGHT TEST**
 ENGINES : (2) TF34-GE-100/-100A

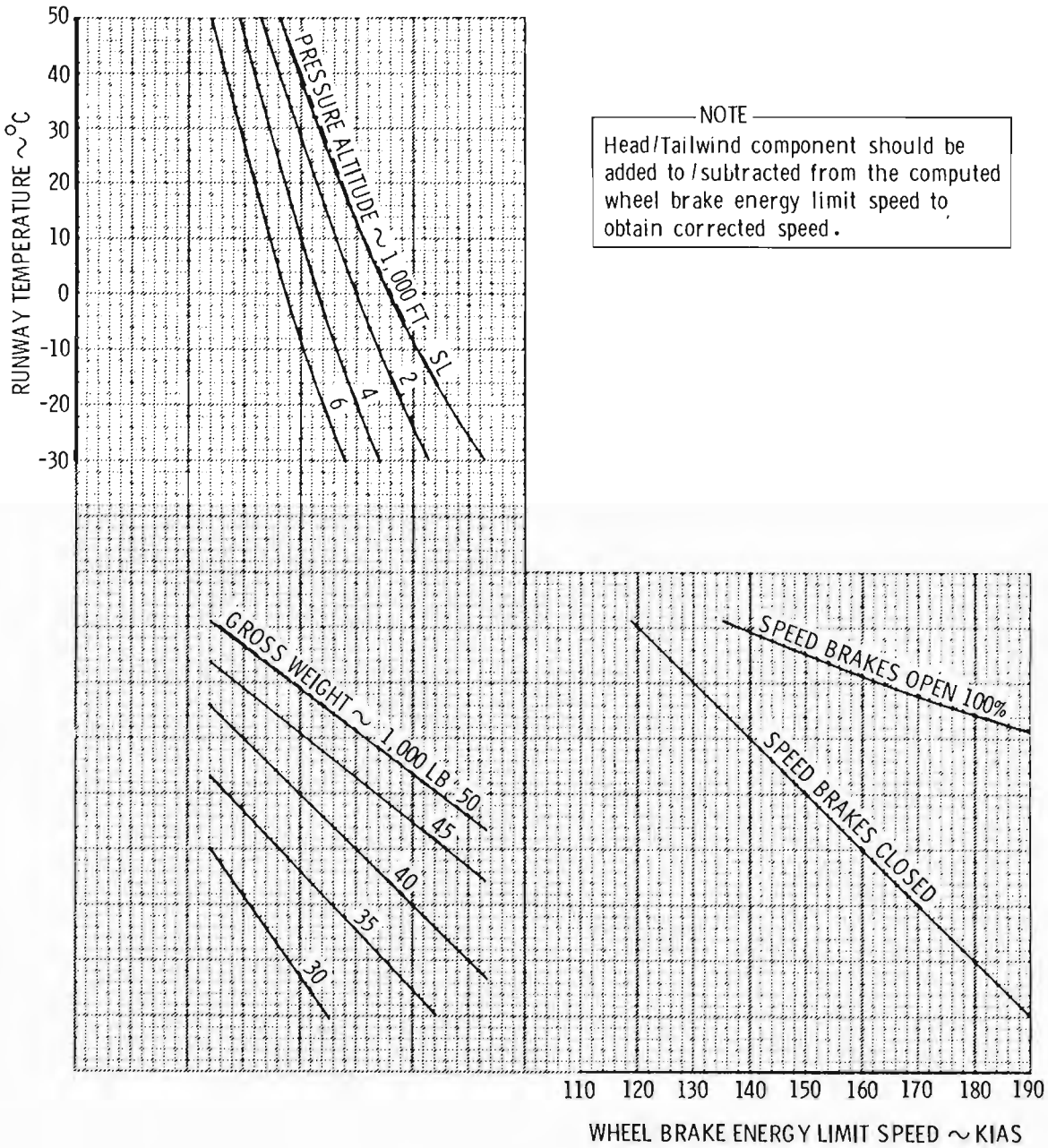

NOTE
 Head/Tailwind component should be added to/subtracted from the computed wheel brake energy limit speed to obtain corrected speed.

Figure A2-13

MODEL : A-10A
 DATE : 30 NOVEMBER 1982
 DATA BASIS : **A . F . FLIGHT TEST**
 ENGINES : (2) TF34-GE-100/-100A

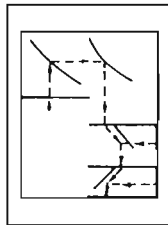

**ACCELERATION
CHECK SPEED**

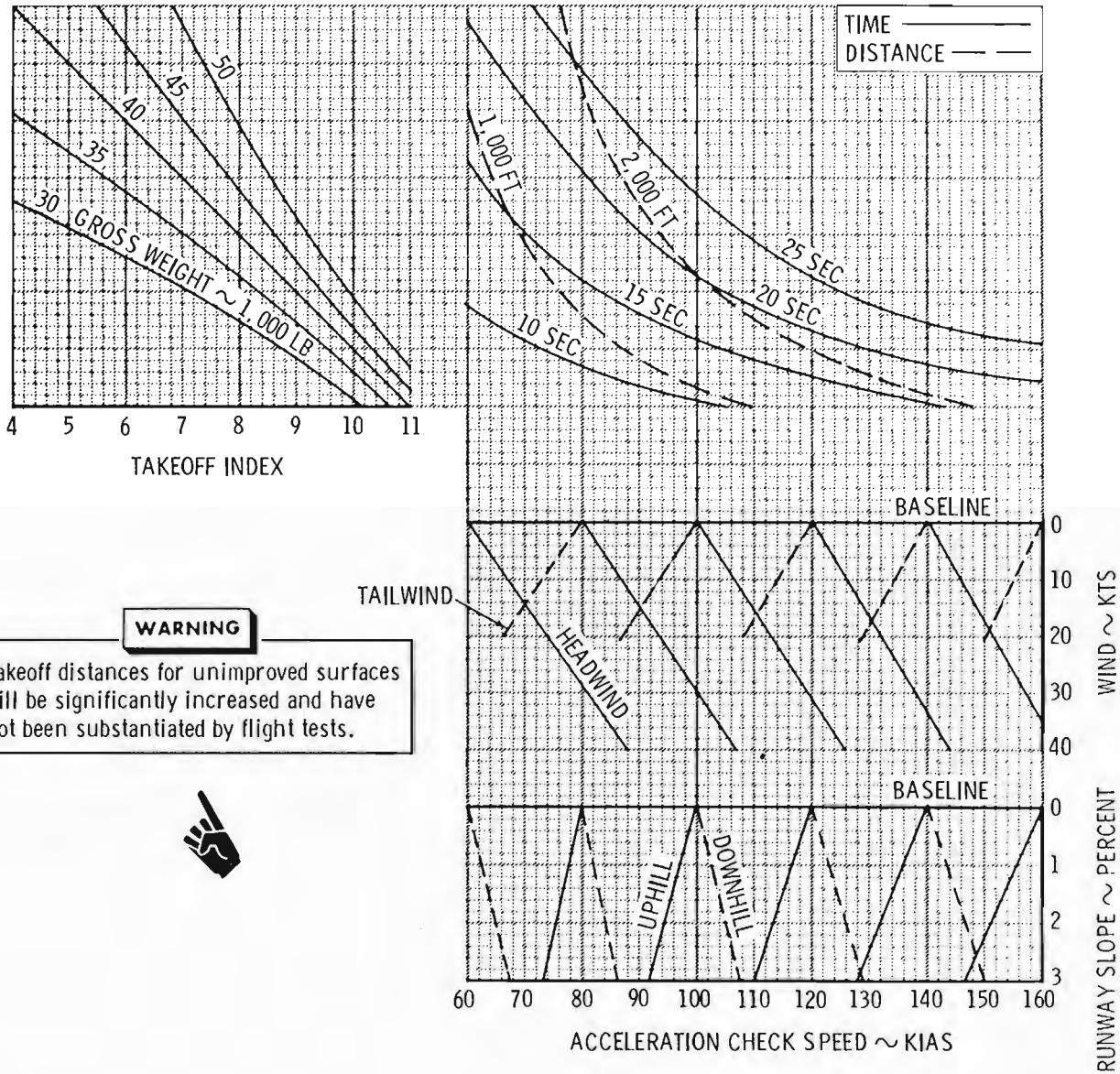

WARNING

● Takeoff distances for unimproved surfaces will be significantly increased and have not been substantiated by flight tests.



B1-1-10A-2-13

Figure A2-14

RUNWAY WIND COMPONENTS

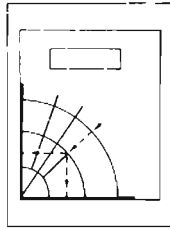

MODEL : A-10A
DATE : 30 NOVEMBER 1982
DATA BASIS : **A.F. FLIGHT TEST**
ENGINES : (2) TF34-GE-100/-100A



NOTE
Enter chart with steady wind to determine headwind or tailwind component and with maximum gust velocity to determine crosswind component.

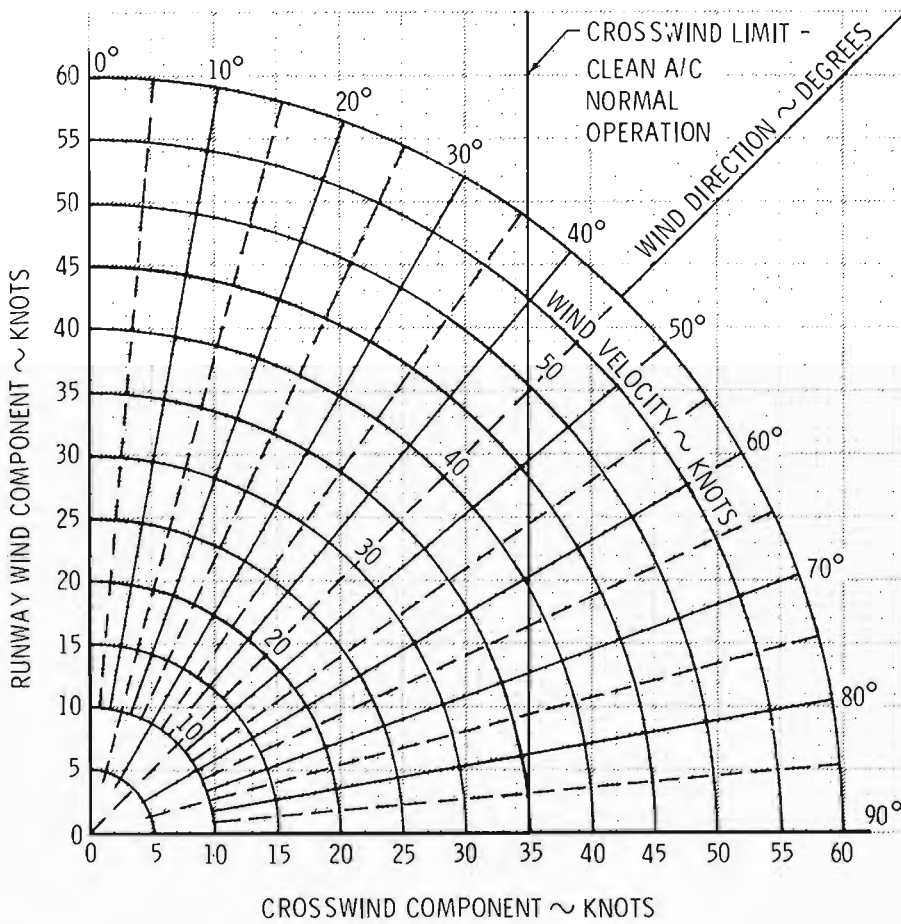

A1-1-10A-2-14

Figure A2-15

**PREDICTED TAKEOFF
FAN SPEED (PTFS)**



MODEL : A-10A
 DATE : 21 MARCH 1984
 DATA BASIS : T.O. 1A-10A-1-1S-10
 ENGINES : (2) TF34-GE-100/100A

WARNING

Fan speeds less than the predicted fan speed will result in reduced single engine rate of climb and will adversely affect other takeoff parameters. Under critical operating conditions (short runway, high gross weight, high temperature, pressure altitude, etc.) an abort may be the appropriate action if predicted fan speed cannot be achieved.

NOTES

- Fan speed should be checked after approximately 1,000 feet on takeoff roll. Since fan speed is a direct indication of thrust, obtaining the fan speed shown below (with or without droop recovery), is necessary to obtain the performance shown in this technical order for maximum power takeoff.
- Approximately four minutes operation at or near maximum power prior to takeoff will minimize thrust droop. Thrust can be increased up to 4% (1.6% fan speed increase by minimizing droop).

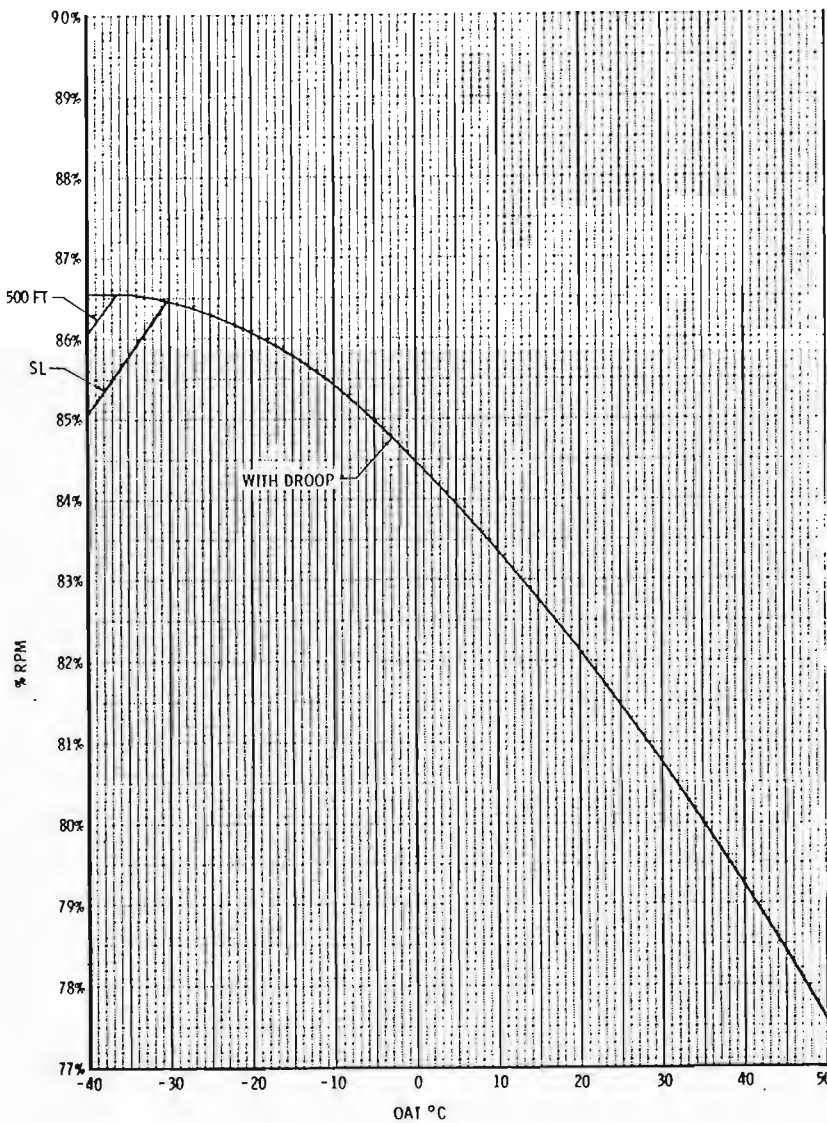
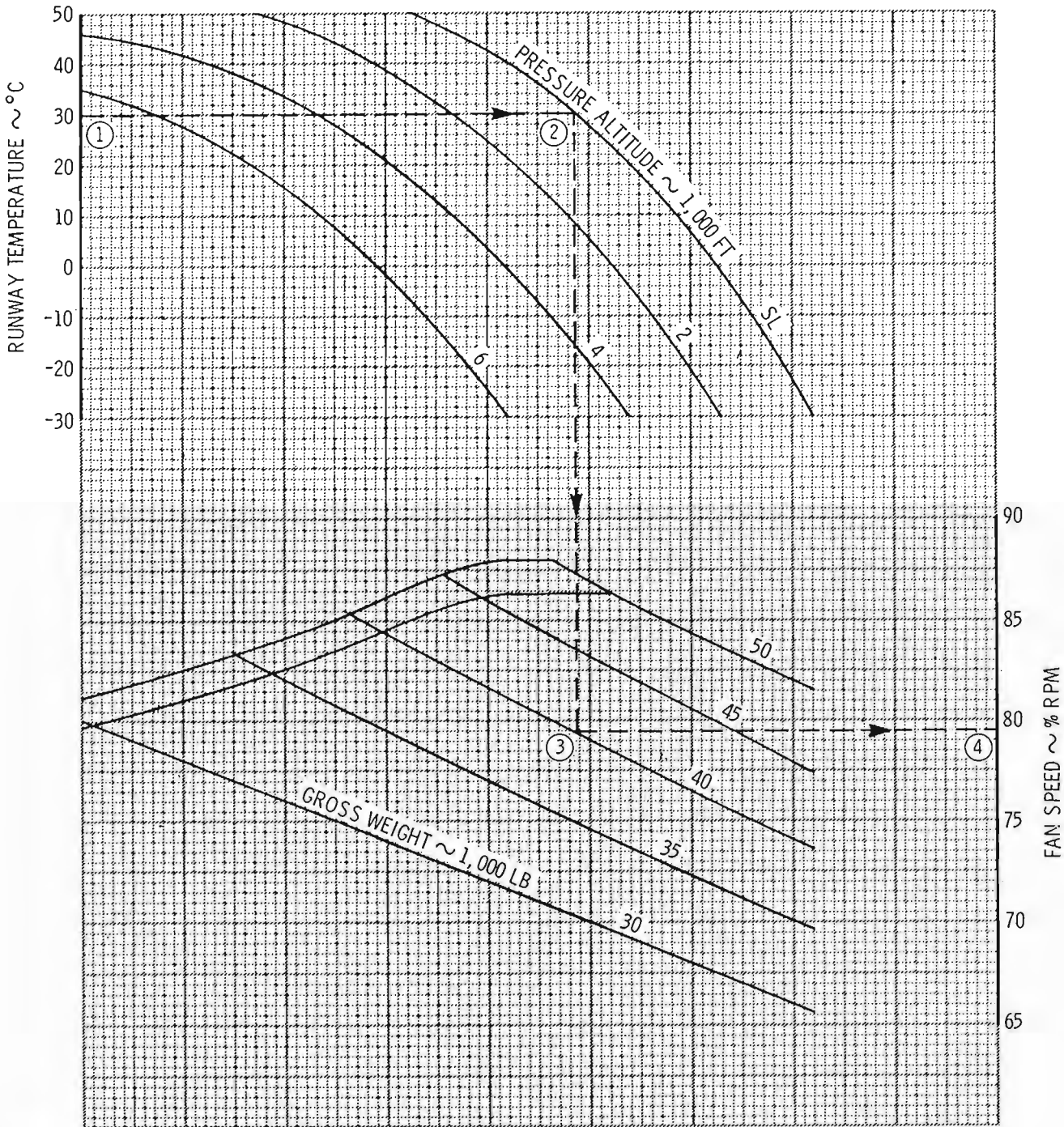

Figure A2-16

MODEL: A-10A
 DATE: 27 APRIL 1987
 DATA BASIS: A.F. FLIGHT TEST
 ENGINES: (2) TF34-GE-100/100A
 FUEL GRADE: JP-4
 FUEL DENSITY: 6.5 LB/US GAL

REQUIRED FAN SPEEDS
 for
 SINGLE ENGINE RATES OF CLIMB
 Flaps 7°, Gear Down,
 Maximum Thrust,
 At Takeoff Speed



MODEL: A-10A
 DATE: 27 APRIL 1987
 DATA BASIS: A.F. FLIGHT TEST
 ENGINES: (2) TF34-GE-100/100A
 FUEL GRADE: JP-4
 FUEL DENSITY: 6.5 LB/US GAL

REQUIRED FAN SPEEDS
 for
 SINGLE ENGINE RATES OF CLIMB
 Flaps 7°, Gear Down,
 Maximum Thrust,
 At Takeoff Speed

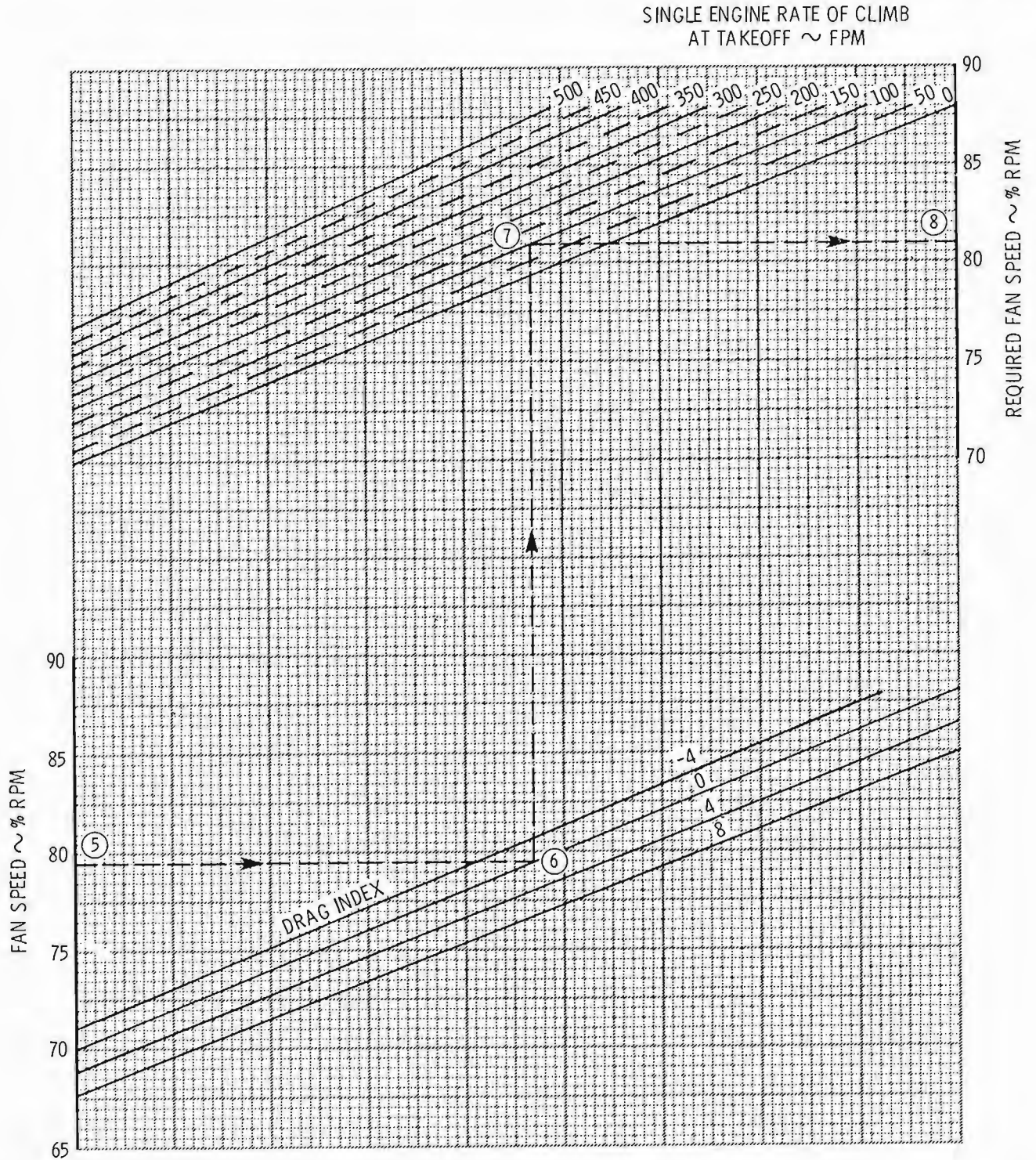

Figure A2 - 17 (Sheet 2 of 2).

MODEL: A-10A
 DATE: 27 APRIL 1987
 DATA BASIS: A.F. FLIGHT TEST
 ENGINES: (2) TF34-GE-100/100A
 FUEL GRADE: JP-4
 FUEL DENSITY: 6.5 LB/US GAL

REQUIRED FAN SPEEDS
 for
 SINGLE ENGINE RATES OF CLIMB
 Flaps 7°, Gear Up,
 Maximum Thrust,
 At Takeoff Speed

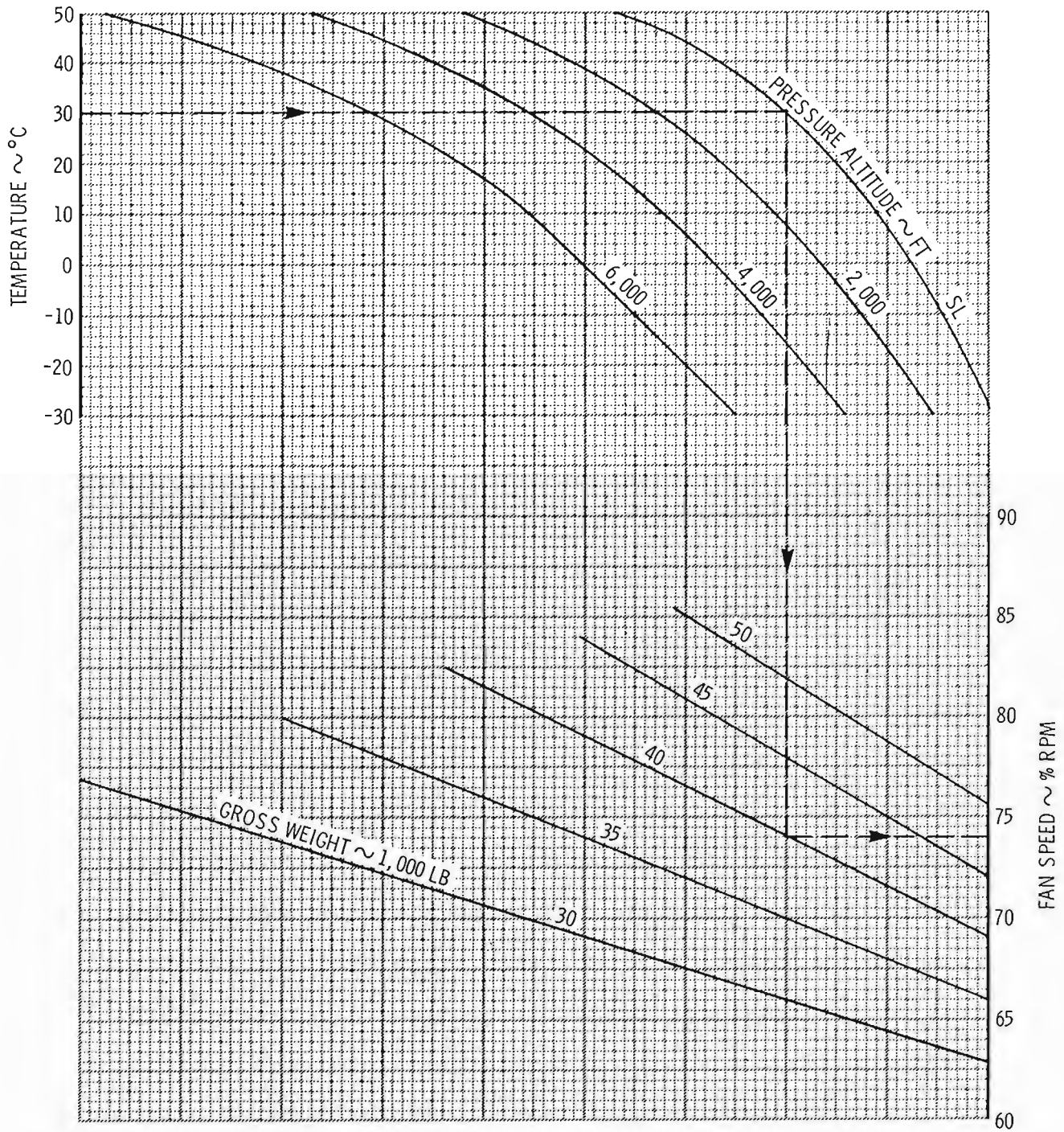

Figure A2 - 18 (Sheet 1 of 2)

MODEL: A-10A
DATE: 27 APRIL 1987
DATA BASIS: A.F. FLIGHT TEST
ENGINES: (2) TF34-GE-100/100A
FUEL GRADE: JP-4
FUEL DENSITY: 6.5 LB/US GAL

REQUIRED FAN SPEEDS
for
SINGLE ENGINE RATES OF CLIMB
Flaps 7°, Gear Up,
Maximum Thrust,
At Takeoff Speed

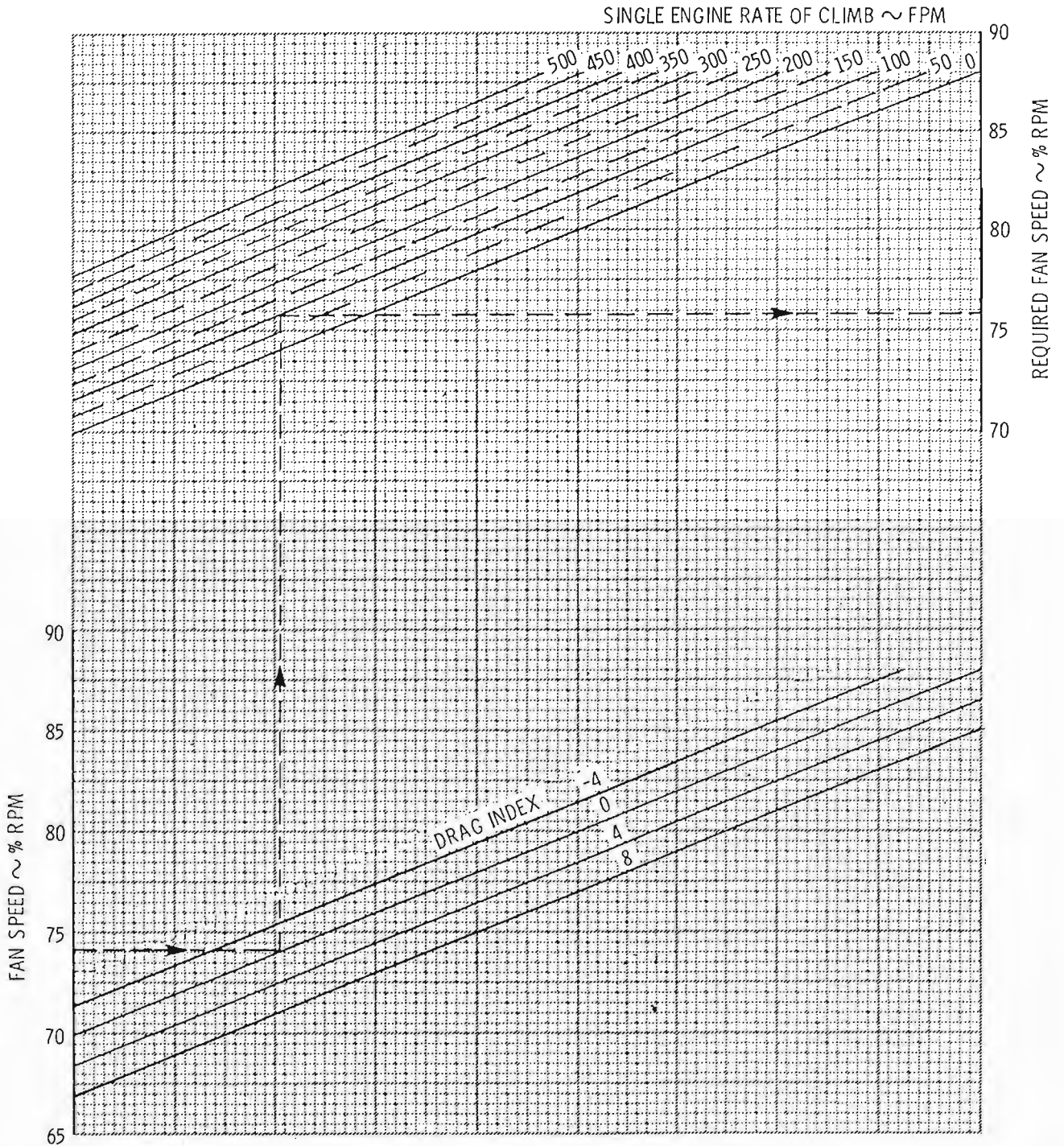
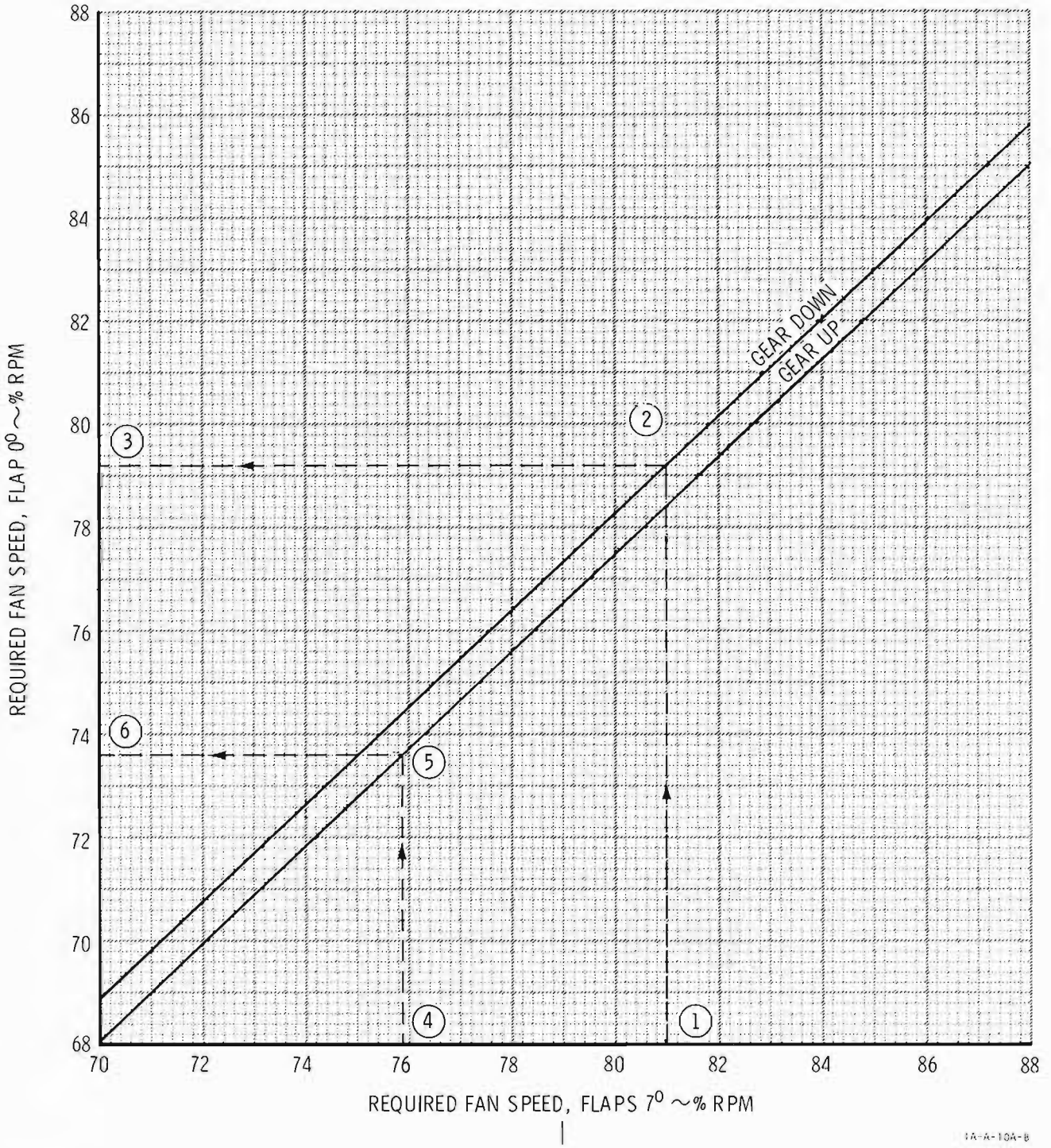

Figure A2 - 18 (Sheet 2 of 2)

MODEL: A-10A
 DATE: 27 APRIL 1987
 DATA BASIS: A. F. FLIGHT TEST

ENGINES: (2) TF34-GE-100/100A
 FUEL GRADE: JP-4
 FUEL DENSITY: 6.5 LB/US GAL

**REQUIRED FAN SPEEDS
 FOR
 SINGLE ENGINE RATES OF CLIMB
 FLAP EFFECT
 Maximum Thrust**



1A-A-10A-B

Figure A2 - 19

MODEL: A-10A
 DATE: 27 APRIL 1987
 DATA BASIS: A. F. FLIGHT TEST

ENGINES: (2) TF34-GE-100/100A
 FUEL GRADE: JP-4
 FUEL DENSITY: 6.5 LB/US GAL

**REQUIRED FAN SPEEDS
 FOR
 BEST SINGLE ENGINE RATES OF CLIMB
 Maximum Thrust Flaps 0°, 7°**

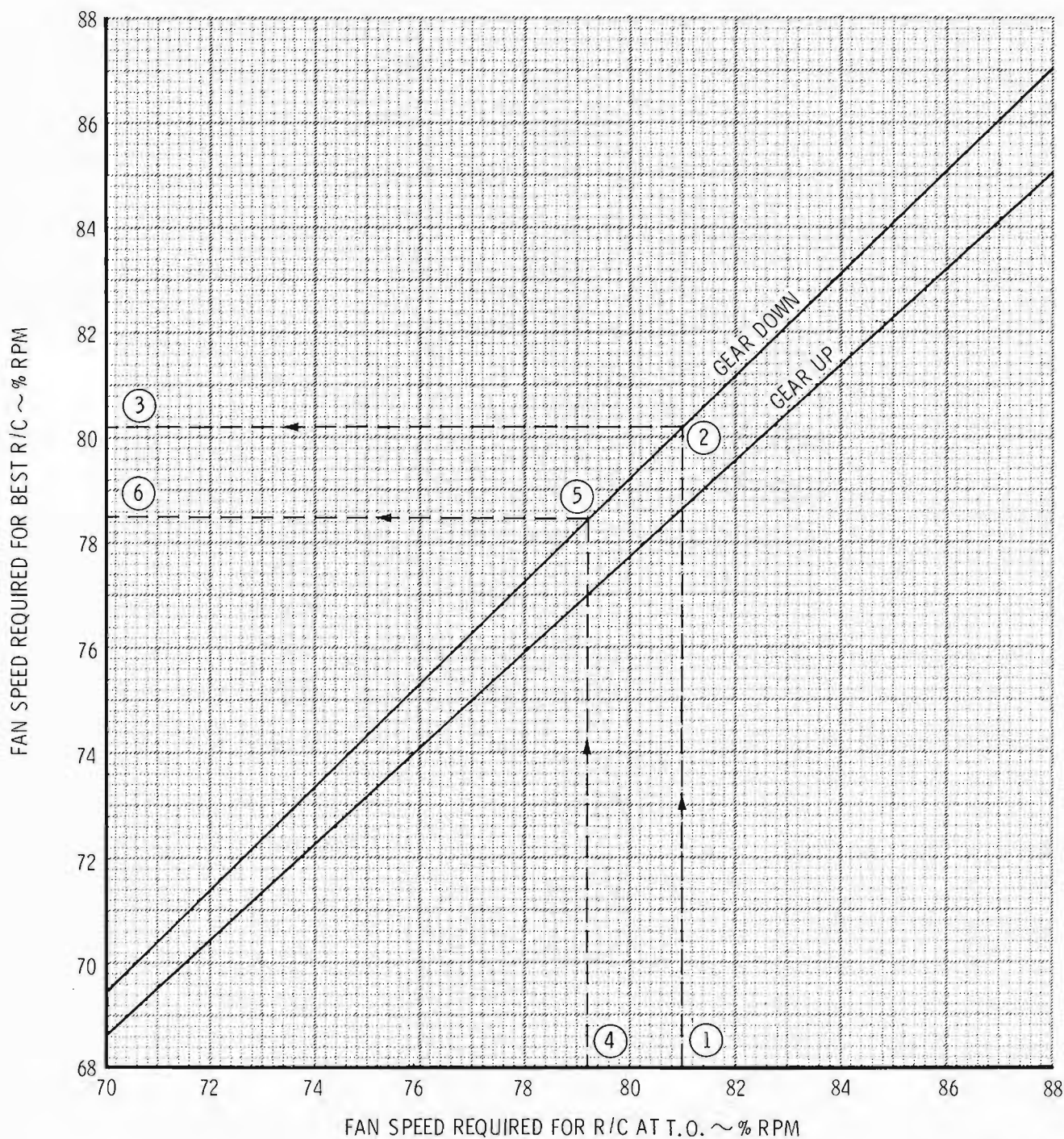

Figure A2 - 20

PART III

CLIMB

TABLE OF CONTENTS

	<u>Page</u>
Climb Charts (General)	A3-1
Maximum and 3% Below PTFS Climb Charts	A3-1
Combat, Cruise, and Service Ceiling Charts	A3-4
Best Single-Engine Rate of Climb Speed Chart	A3-5
Single-Engine Rate of Climb Chart	A3-6

LIST OF CHARTS

<u>Figure</u>		<u>Page</u>
A3-1	Maximum Thrust Climb	A3-8
A3-2	3% Below PTFS	A3-10
A3-3	Combat Ceiling (500 FPM)	A3-12
A3-4	Cruise Ceiling (300 FPM) and Service Ceiling (100 FPM)	A3-13
A3-5	Best Single-Engine Rate of Climb Speed	A3-14
A3-6	Single-Engine Rate of Climb	A3-15
A3-7	Maximum Thrust Climb, Single Engine	A3-16
A3-8	Cruise Ceiling (300 FPM), Single-Engine	A3-18
A3-9	Service Ceiling (100 FPM), Single-Engine	A3-19

CLIMB CHARTS (GENERAL)

The climb charts provide a means of determining aircraft climb performance, which includes time, distance, and fuel required to climb from sea level to altitude or between any two altitudes. The time, distance, and fuel required to climb from sea level to any altitude are presented for all gross weights and drag indexes for both maximum and 3% below PTFS. In addition, maximum thrust single-engine climb performance data are presented. The climb speed schedules are based on providing maximum rates of climb at each altitude. Combat, cruise, and service ceiling data for dual- and single-engine operation are also presented as functions of gross weight and drag index. All climbs are shown for standard day and standard day $\pm 20^{\circ}\text{C}$ temperatures.

MAXIMUM AND 3% BELOW PTFS THRUST CLIMB CHARTS

The chart for maximum thrust climb is contained on figure A3-1 and the chart for 3% below PTFS climb is contained on figure A3-2. Maximum thrust climb for single-engine operation with one engine at maximum and the inoperative engine windmilling is presented on figure A3-7. Each climb chart consists of two sheets. Sheet 1 is used to obtain fuel used as a function of sea level gross weight, pressure altitude, drag index, and temperature. Sheet 2 is used to obtain time to climb and distance traveled as a function of sea level gross weight, pressure altitude, drag index, and temperature. The temperature correction scale on the left side of each chart corrects for colder- or hotter-than-standard day conditions. The recommended climb

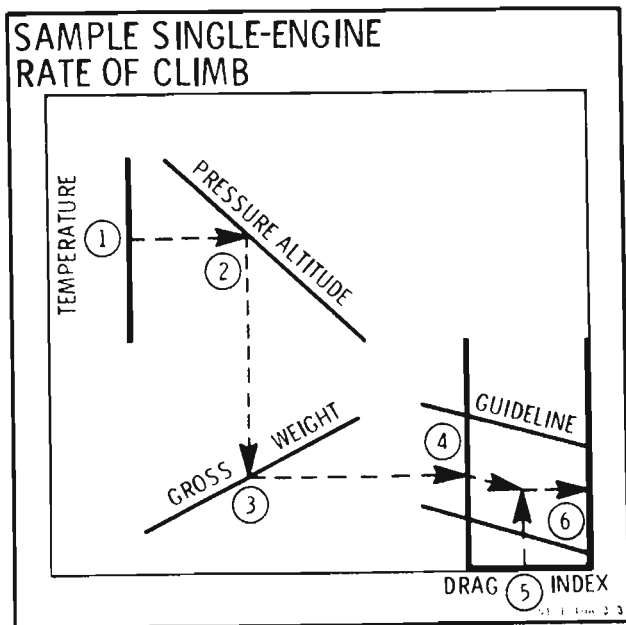

sure altitude. Proceed down to the desired drag index and then left to the temperature baseline. If the temperature is standard, proceed across; if not, contour the nearest guideline for hotter or colder temperature variation and then proceed across to read fuel used.

Enter sheet 2 with the start climb gross weight and move to the right to the pressure altitude. Proceed down through the drag index of the time portion of the chart and continue down to the drag index of the distance portion of the chart. At each point of intersection of the drag index, project to the left and read time and distance, respectively.

Sample Problem

Given:

- A. Start climb pressure altitude = 5,000 ft
- B. Start climb gross weight = 40,000 lb
- C. Thrust setting = MAXIMUM
- D. Desired cruise altitude = 25,000 ft
- E. Drag index = -0.65
- F. Temperature variation from standard day = -10°C

Calculate:

Fuel, time, and distance required for a climb from 2,000 feet field elevation to 25,000 feet pressure altitude.

Use maximum thrust climb, fuel used chart, figure A3-1, sheet 1.

- | | |
|----------------------------------|-----------|
| 1. Start climb gross weight | 40,000 lb |
| 2. Start climb pressure altitude | 5,000 ft |
| 3. Drag index | -0.65 |
| 4. Go to temperature baseline | |

schedule is shown in tabular form on each sheet 1 of the various climb charts. These speeds represent the speeds at which maximum rate of climb occurs at each pressure altitude. The standard day cruise ceiling is shown on the chart for an aircraft with drag index of zero.

If the climb starts at sea level, enter the climb performance charts with sea level gross weight and proceed to the right to the end climb altitude, then drop down to the desired drag index value, and left to the temperature baseline. Continue through the temperature correction grid if standard day temperature is used. If a temperature correction is required, contour the nearest guideline to the desired temperature variation, then proceed left to read fuel, time, or distance.

If the climb begins at an altitude other than sea level, the fuel required to climb from one altitude to another altitude is the fuel required from sea level to the higher altitude less the fuel required from sea level to the lower altitude. Time and distance are obtained in the same manner.

DIRECTIONS FOR USE OF CHARTS

Enter sheet 1 with the start climb gross weight and proceed to the right to the pres-

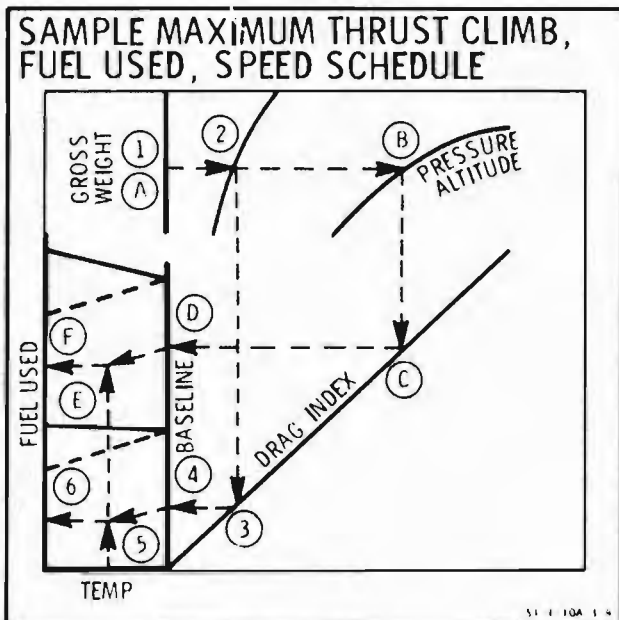

- 5. Temperature variation from standard day -10°C
- 6. Fuel used 100 lb

Reenter figure A3-1, sheet 1, to determine fuel used from sea level to the desired cruise altitude:

- A. Start climb gross weight 40,000 lb
- B. Pressure altitude 25,000 ft
- C. Drag index -0.65
- D. Go to temperature baseline
- E. Temperature variation from standard day -10°C
- F. Fuel used 770 lb

Fuel used (25,000 ft) - fuel used (2,000 ft) = fuel required to climb from 2,000 - 25,000 ft. Thus:

$$770 \text{ lb} - 100 \text{ lb} = 670 \text{ lb}$$

Use maximum thrust climb, time, and distance chart, figure A3-1, sheet 2:

- 7. Start climb gross weight 40,000 lb

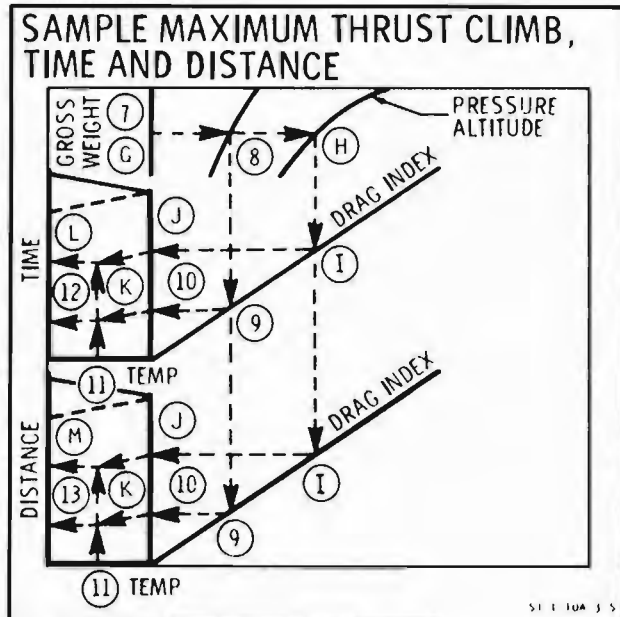

- 8. Start climb pressure altitude 5,000 ft
- 9. Drag index -0.65
- 10. Go to temperature baseline
- 11. Temperature variation from standard day -10°C
- 12. Time 1 min
- 13. Distance 4 NM

Reenter figure A3-1, sheet 2, to determine time and distance to climb from sea level to the desired cruise altitude:

- G. Start climb gross weight 40,000 lb
- H. Desired cruise altitude 25,000 ft
- I. Drag index -0.65
- J. Go to temperature baseline
- K. Temperature variation from standard day -10°C
- L. Time 9 min
- M. Distance 35 NM

Time (25,000 ft) - time (5,000 ft) = time required to climb from 2,000 - 25,000 ft.
Thus:

$$9 \text{ min} - 1 \text{ min} = 8 \text{ min}$$

Distance (25,000 ft) - distance (2,000 ft) = distance to climb from 2,000 - 25,000 ft.
Thus:

$$35 \text{ NM} - 4 \text{ NM} = 31 \text{ NM}$$

COMBAT, CRUISE, AND SERVICE CEILING CHARTS

The combat ceiling chart (rate of climb = 500 fpm) for maximum thrust is presented on figure A3-3. The cruise (rate of climb = 300 fpm) and service (rate of climb = 100 fpm) ceiling chart for 3% below PTFS is presented on figure A3-4. Single-engine cruise and service ceiling data for 3% below PTFS are presented on figures A3-8 and A3-9, respectively. These charts determine the applicable ceilings as a function of actual gross weight at altitude, drag index, and temperature variation from standard day.

DIRECTIONS FOR USE OF CHARTS

Enter the appropriate chart with gross weight, proceed up to the drag index, and then proceed to the left to the temperature baseline. If temperature is standard, proceed across; if not, contour the nearest guideline for hotter- or colder-than-standard day temperature and then proceed across to read the pressure altitude (appropriate ceiling).

Sample Problem

Given:

- A. Gross weight (at altitude) = 37,500 lb
- B. Temperature variation from standard day = -10°C
- C. Drag index = -0.65

Calculate:

- A. Combat ceiling
- B. Cruise ceiling
- C. Use combat ceiling chart, figure A3-3
 - 1. Gross weight 37,500 lb
 - 2. Drag index -0.65
 - 3. Go to temperature baseline
 - 4. Temperature variation from standard day -10°C
 - 5. Combat ceiling 32,000 ft
- D. Use cruise and service ceiling chart, figure A3-4, top portion of chart:
 - 1. Gross weight 37,500 lb
 - 2. Drag index -0.65
 - 3. Go to temperature baseline

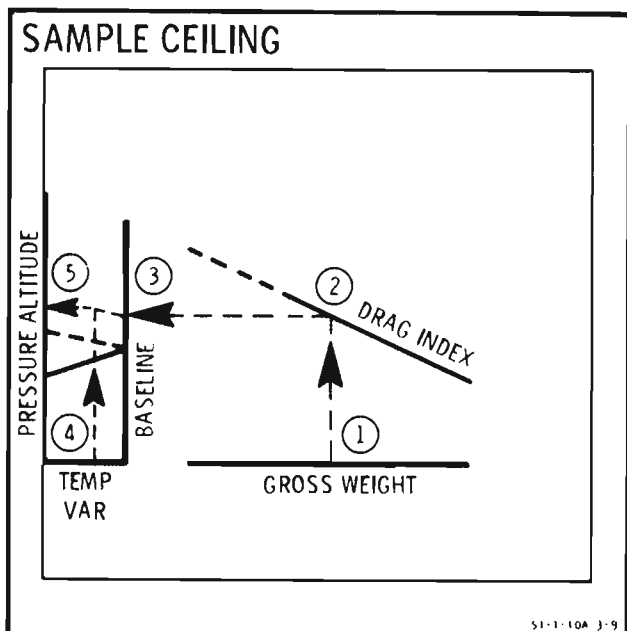

4. Temperature variation from standard day -10°C
5. Cruise ceiling 32,800 ft

E. Use cruise and service ceiling chart, figure A3-4, bottom portion of chart:

1. Gross weight 37,500 lb
2. Drag index -0.65
3. Go to temperature baseline
4. Temperature variation from standard day -10°C
5. Service ceiling 34,600 ft

BEST SINGLE-ENGINE RATE OF CLIMB SPEED CHART

The best single-engine rate of climb speed chart, figure A3-5, presents climb speed data with one engine at maximum thrust and the inoperative engine windmilling. The data are based on flaps 7°, and landing gear down. Effects of runway temperature, pressure altitude, gross weight, and drag index are shown on the chart. Note the corrections to be applied for landing gear up and/or flaps 0°. These corrections are to be applied to the values obtained directly from the chart. When the aircraft is flown at these speeds, the resultant rates of climb are as shown on figure A3-6.

Note

The value obtained from this chart should be compared to the computed takeoff speed obtained from figure A2-2. If the value obtained for the gear down best climb speed is less than the takeoff speed, use takeoff speed for best single-engine climb speed with gear down.

DIRECTIONS FOR USE OF CHART

Enter the best single-engine climb speed chart with runway temperature, proceed to the right to the pressure altitude, and then

drop vertically down to the desired gross weight. At the point of intersection with the weight curve, proceed horizontally to the right to the drag index baseline. If drag index is zero, proceed to the right to read the best single-engine climb speed. If the drag index is not zero, contour the guidelines to the desired drag index and then proceed across to the right to read the best single-engine climb speed. At this time, the corrections for flaps 0° and/or gear up can be applied to the chart value.

Sample Problem

Given:

- A. Runway temperature = 15°C
- B. Pressure altitude = 1,000 ft
- C. Gross weight = 40,000 lb
- D. Drag index = -0.65
- E. Flap setting = 7°
- F. Landing gear position = down

Calculate:

- A. Best single-engine climb speed, maximum thrust, flaps 7°, landing gear down
- B. Use best single-engine climb speed chart, figure A3-5

1. Runway temperature 15°C
2. Pressure altitude 1,000 ft
3. Gross weight 40,000 lb
4. Go to drag index baseline
5. Drag index -0.65
6. Best single-engine climb speed (flaps 7°, gear down) 148 KIAS
Takeoff speed (flaps 7°) (from figure A2-2) 137 KIAS

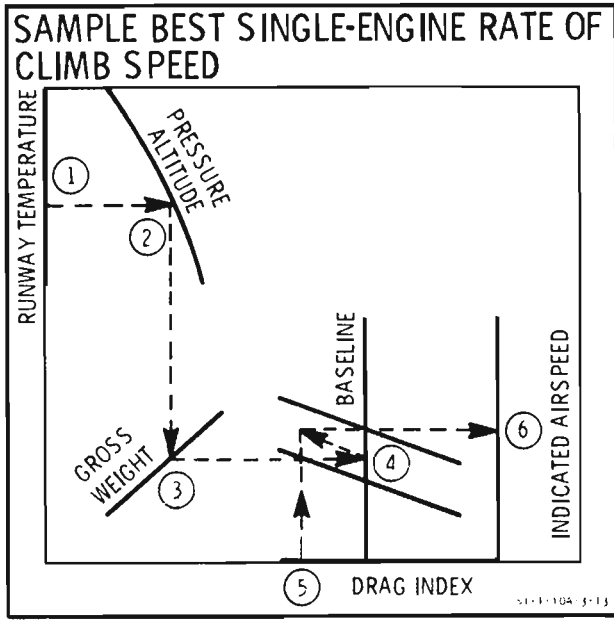

Therefore, best gear down climb speed 148 KIAS

Best single-engine climb speed (flaps 7°, gear up) 158 KIAS

Best single-engine climb speed (flaps 0°, gear up) 168 KIAS

SINGLE-ENGINE RATE OF CLIMB CHART

The single-engine rate of climb chart, figure A3-6, presents rate of climb performance data with one engine at maximum thrust and the inoperative engine windmilling. The data are based on flaps 7°, landing gear down, and at the speed corresponding to the best rate of climb. Effects of runway temperature, pressure altitude, gross weight, and drag index are shown on the chart. Note the corrections to be applied for flaps 0° and/or landing gear up. These corrections are to be applied to the values obtained directly from the chart.

DIRECTIONS FOR USE OF CHART

Enter the single-engine rate of climb chart with the runway temperature, proceed to the right to the pressure altitude, and then drop vertically down to the desired gross weight. At the point of intersection with the weight curve, proceed horizontally to the right to the baseline of the drag index scale.

If drag index is zero, proceed across to the right to read single-engine rate of climb. If drag index is not zero, contour the guide-lines to the desired drag index and then proceed across to the right to read the single-engine rate of climb. If flaps are 0° and/or landing gear is up (retracted), then the appropriate corrections must be added to the chart value.

Sample Problem

Given:

- A. Runway temperature = 15°C
- B. Pressure altitude = 1,000 ft
- C. Gross weight = 40,000 lb
- D. Drag index = -0.65
- E. Flap setting = 7°
- F. Landing gear position = down

Calculate:

A. Single-engine rate of climb at speed for best rate of climb, maximum thrust, flaps 7°, and landing gear down

B. Use single-engine rate of climb chart, figure A3-6

- | | |
|--|-----------|
| 1. Runway temperature | 15°C |
| 2. Pressure altitude | 1,000 ft |
| 3. Gross weight | 40,000 lb |
| 4. Go to drag index baseline | |
| 5. Drag index | -0.65 |
| 6. Single-engine rate of climb (flaps 7°, gear down) | +250 fpm |
| Single-engine rate of climb (flaps 0°, gear up) | +900 fpm |

This page intentionally left blank

**MAXIMUM THRUST CLIMB
Fuel Used, Speed Schedule**

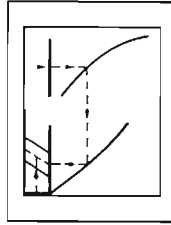

MODEL : A-10A
 DATE : 30 NOVEMBER 1982
 DATA BASIS : **A . F . FLIGHT TEST**
 ENGINES : (2) TF34-GE-100/-100A

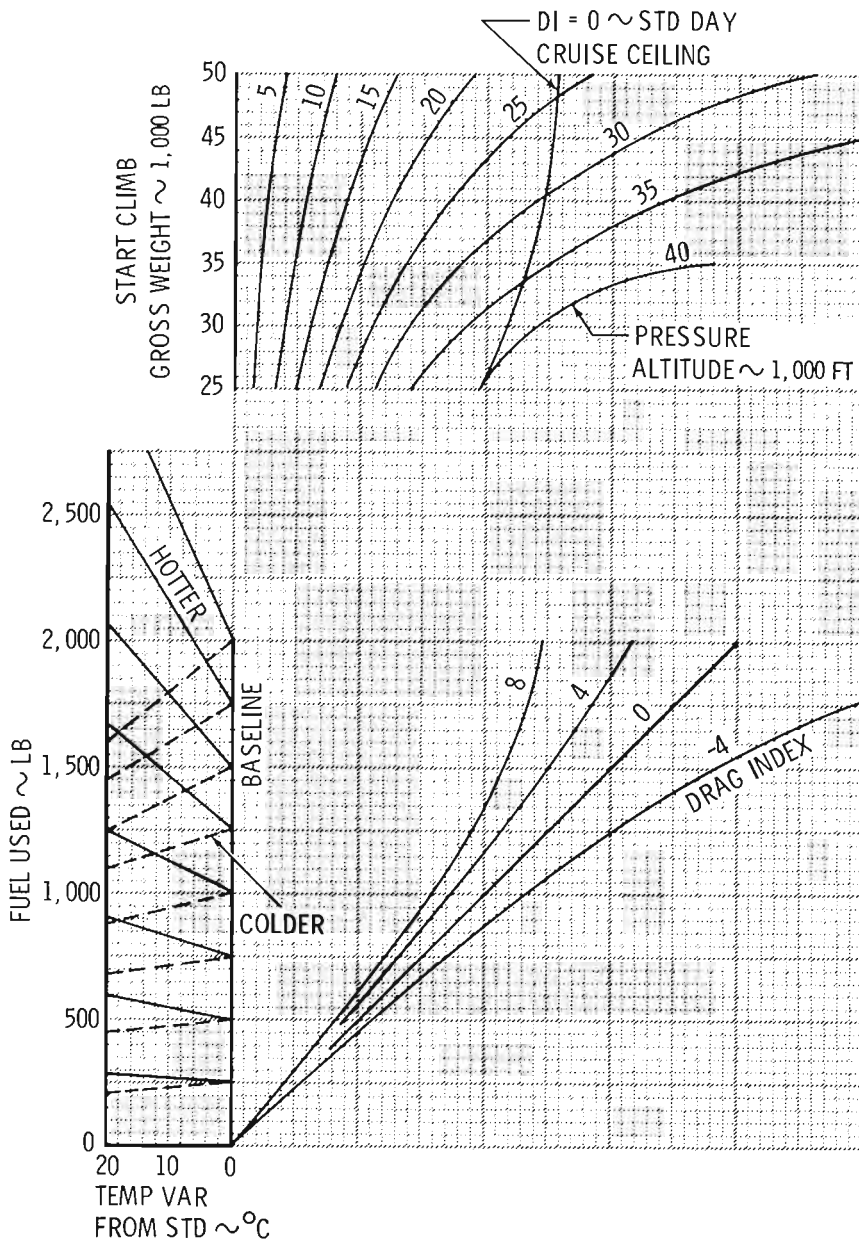

START, TAXI, TAKEOFF, AND
 ACCELERATE TO CLIMB SPEED
 PLANNING FACTORS

FUEL USED	500 LB
DISTANCE (BRAKE RELEASE TO CLIMB SPEED)	2 NM
TIME (BRAKE RELEASE TO CLIMB SPEED)	1 MIN

CLIMB SPEED SCHEDULE
 ALL GROSS WEIGHTS,
 DRAG INDEXES

PRESSURE ALTITUDE	INDICATED AIRSPEED
~ 1,000 FT	~ KIAS
SEA LEVEL	200
5	195
10	190
15	185
20	180
25	175
30	170
35	165
40	160

A1-1-10A-3-4

Figure A3-1 (Sheet 1 of 2)

MODEL : A-10A
 DATE : 30 NOVEMBER 1982
 DATA BASIS : A . F . FLIGHT TEST
 ENGINES : (2) TF34-GE-100/-100A

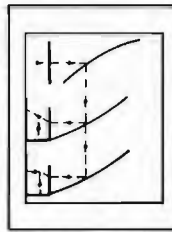

**MAXIMUM THRUST CLIMB
 Time and Distance**

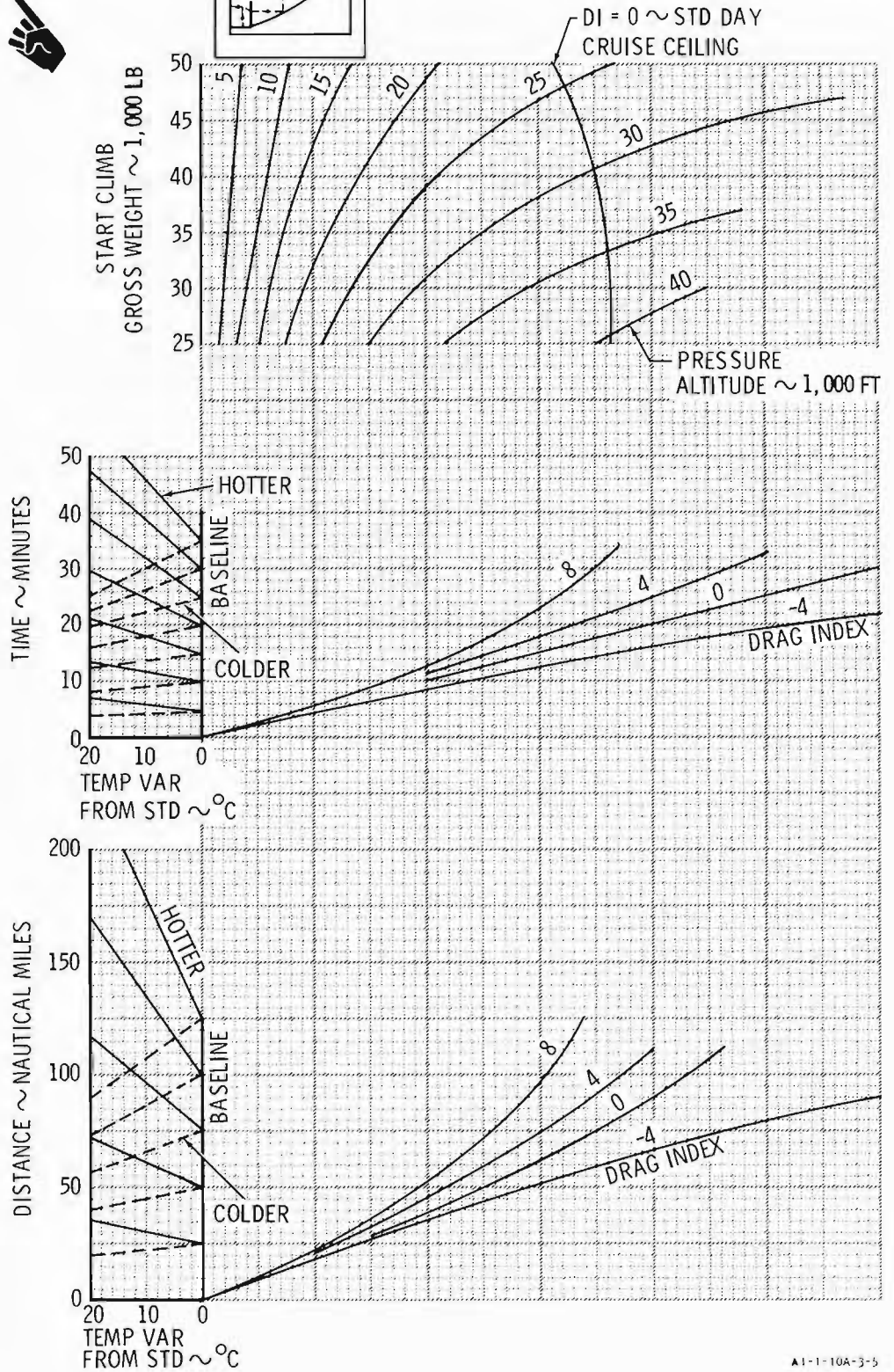

A1-1-10A-3-5

Figure A3-1 (Sheet 2 of 2)

3% BELOW PREDICTED FAN SPEED CLIMB
Fuel Used and Speed Schedule

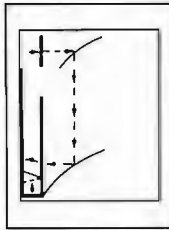

MODEL : A-10A
 DATE : 30 NOVEMBER 1982
 DATA BASIS : A . F. FLIGHT TEST
 ENGINES : (2) TF34-GE-100/-100A

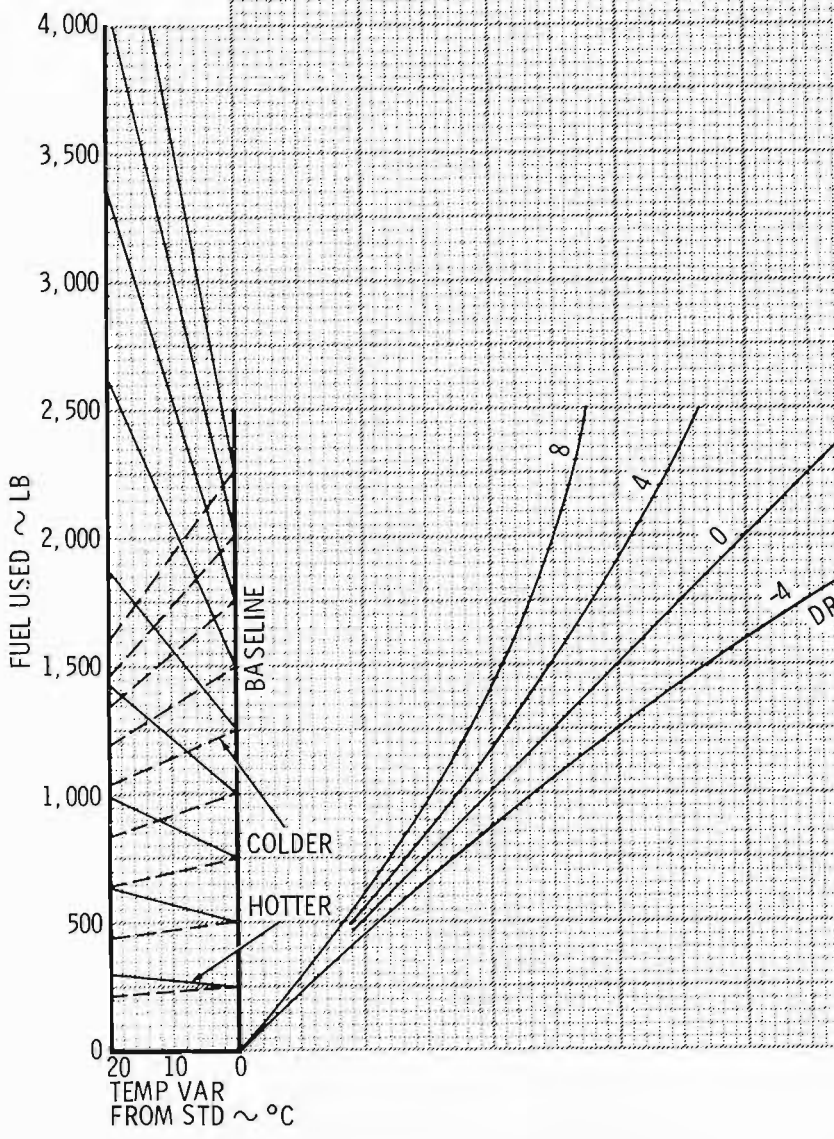
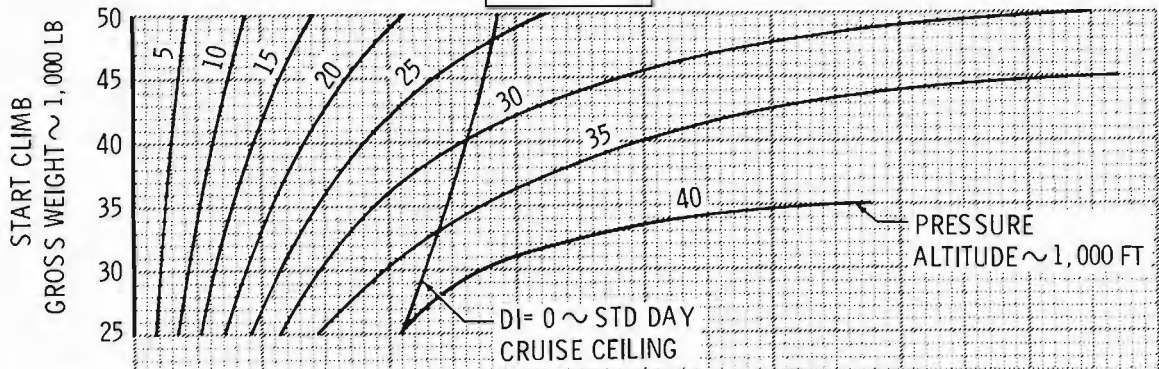

START, TAXI, TAKEOFF, AND ACCELERATE TO CLIMB SPEED PLANNING FACTORS

FUEL USED	500 LB
DISTANCE (BRAKE RELEASE TO CLIMB SPEED)	2 NM
TIME (BRAKE RELEASE TO CLIMB SPEED)	1 MIN

CLIMB SPEED SCHEDULE ALL GROSS WEIGHTS, DRAG INDEXES	
PRESSURE ALTITUDE	INDICATED AIRSPEED
~ 1,000 FT	KIAS
SEA LEVEL	200
5	195
10	190
15	185
20	180
25	175
30	170
35	165
40	160

A1-1-10A-3-1

Figure A3-2 (Sheet 1 of 2)

MODEL : A-10A
 DATE : 30 NOVEMBER 1982
 DATA BASIS : **A . F . FLIGHT TEST**
 ENGINES : (2) TF34-GE-100/-100A

**3% BELOW PREDICTED FAN
 SPEED CLIMB**
 Time and Distance

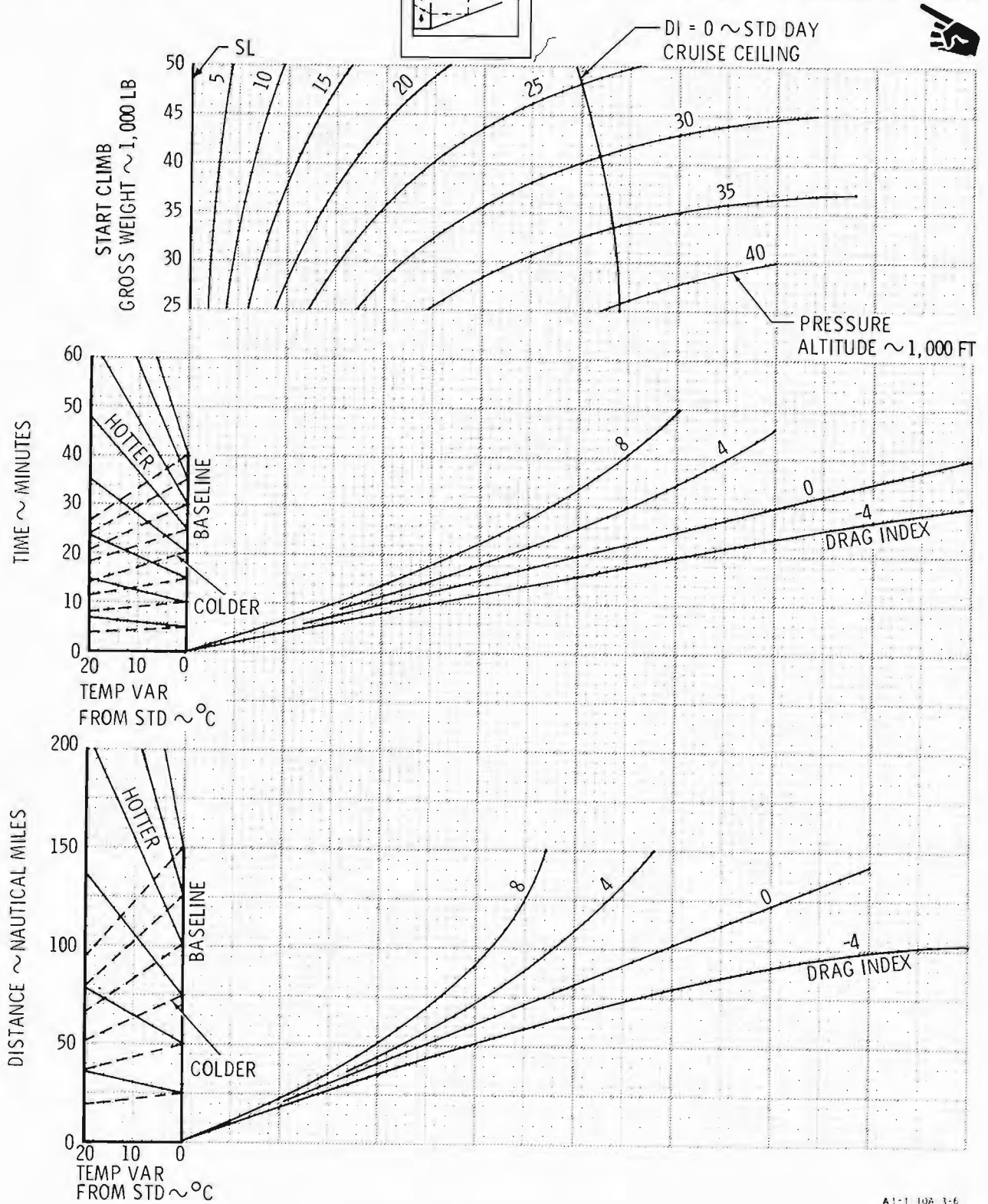

A1-1 10A 3-6

Figure A3-2 (Sheet 2 of 2)

**COMBAT CEILING (500 FPM)
Maximum Thrust**

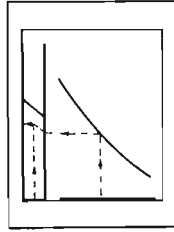

MODEL : A-10A
DATE : 30 NOVEMBER 1982
DATA BASIS : **A . F. FLIGHT TEST**
ENGINES : (2) TF34-GE-100/-100A

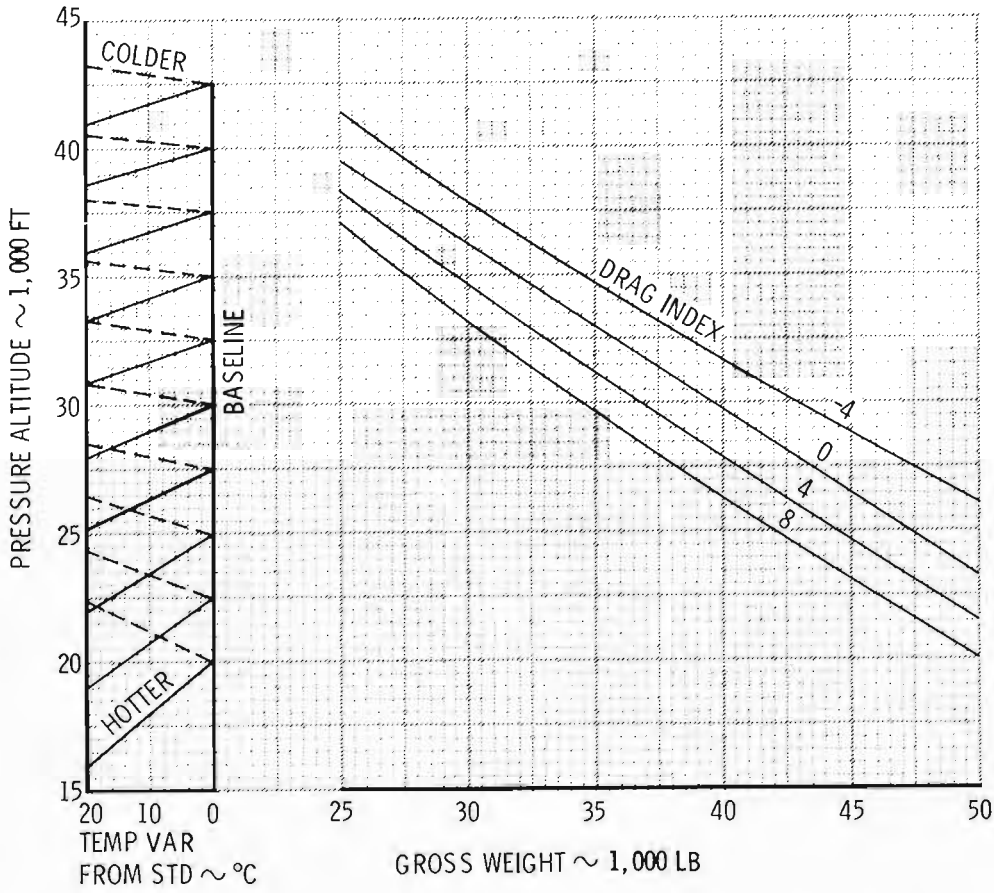

A1-10A-3-9

Figure A3-3

MODEL : A-10A
 DATE : 30 NOVEMBER 1982
 DATA BASIS : A.F. FLIGHT TEST
 ENGINES : (2) TF34-GE-100/-100A

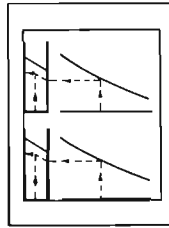

**CRUISE CEILING (300 FPM)
 AND
 SERVICE CEILING (100 FPM)
 3% Below Predicted Fan Speed**

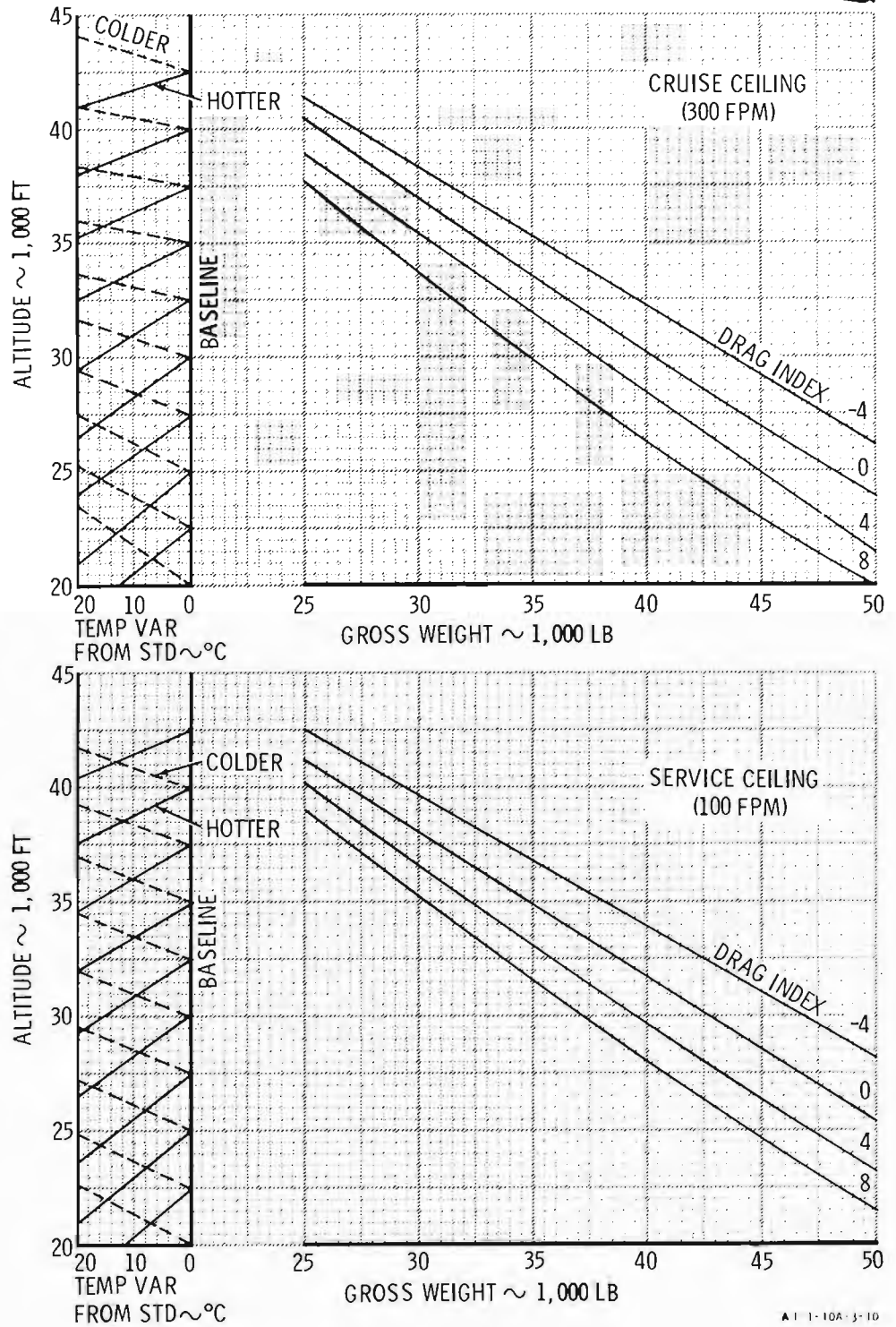
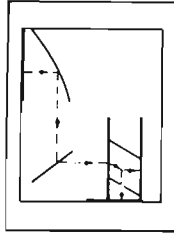
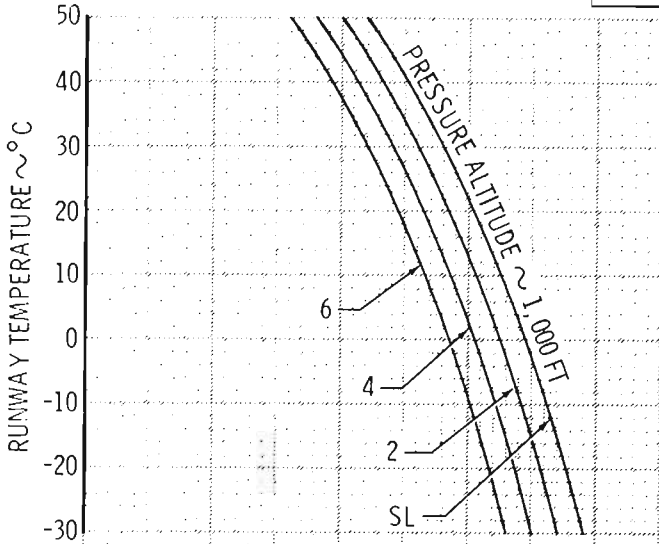

Figure A3-4

**BEST SINGLE-ENGINE
RATE OF CLIMB SPEED
Flaps 7°, Gear Down
Maximum Thrust
Failed Engine Windmilling**



MODEL : A-10A
DATE : 30 NOVEMBER 1982
DATA BASIS : A . F . FLIGHT TEST
ENGINES : (2) TF34-GE-100/100A



- NOTES
- Compare chart value with computed takeoff speed. If value for gear down best climb speed is less than takeoff speed, use takeoff speed as best single-engine climb speed.
 - Add 10 KIAS for gear up.
 - Add another 10 KIAS for flaps up.

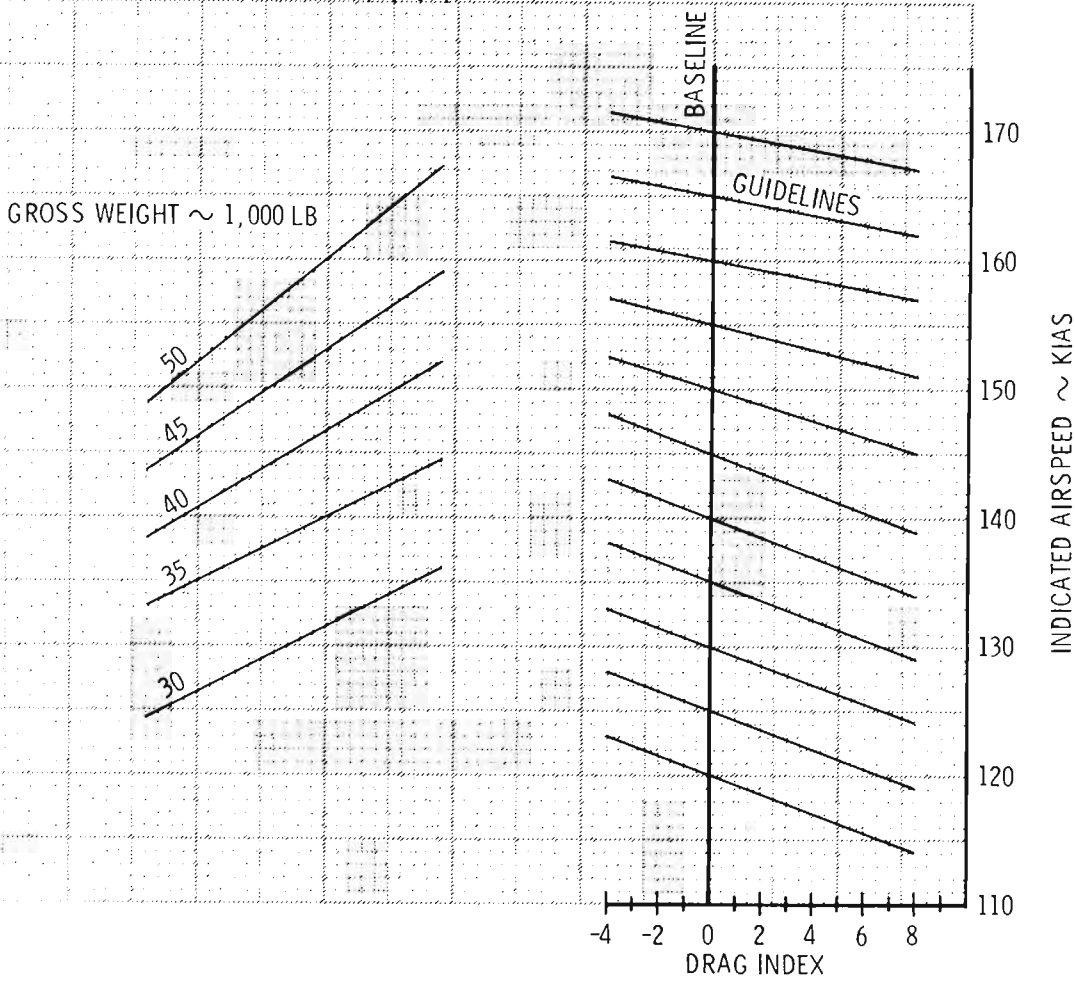

A11-10A-3-11

Figure A3-5

MODEL : A-10A
 DATE : 30 NOVEMBER 1982
 DATA BASIS : A.F. FLIGHT TEST
 ENGINES : (2) TF34-GE-100/-100A

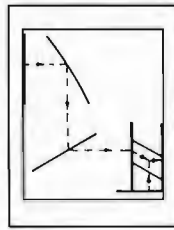

SINGLE-ENGINE RATE OF CLIMB OF CLIMB
Flaps 7°, Gear Down,
Maximum Thrust
at best rate of climb speed
Failed Engine Windmilling

- NOTES
- With landing gear up, add 500 fpm.
 - With flaps 0°, add 150 fpm.
 - With 3% Below Predicted Fan Speed, subtract 250 fpm.

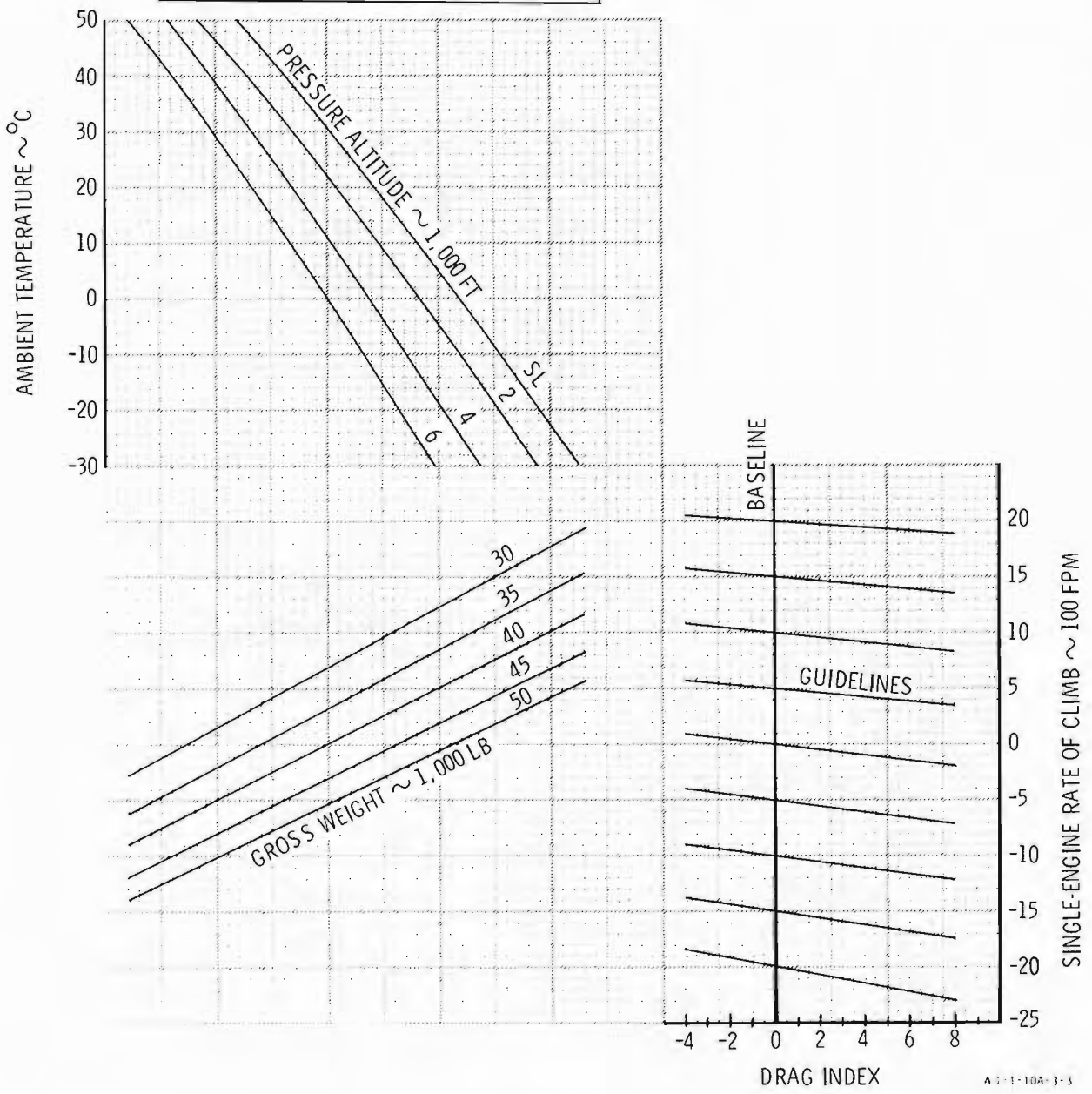
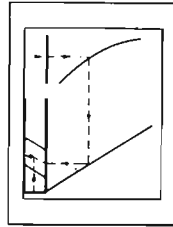
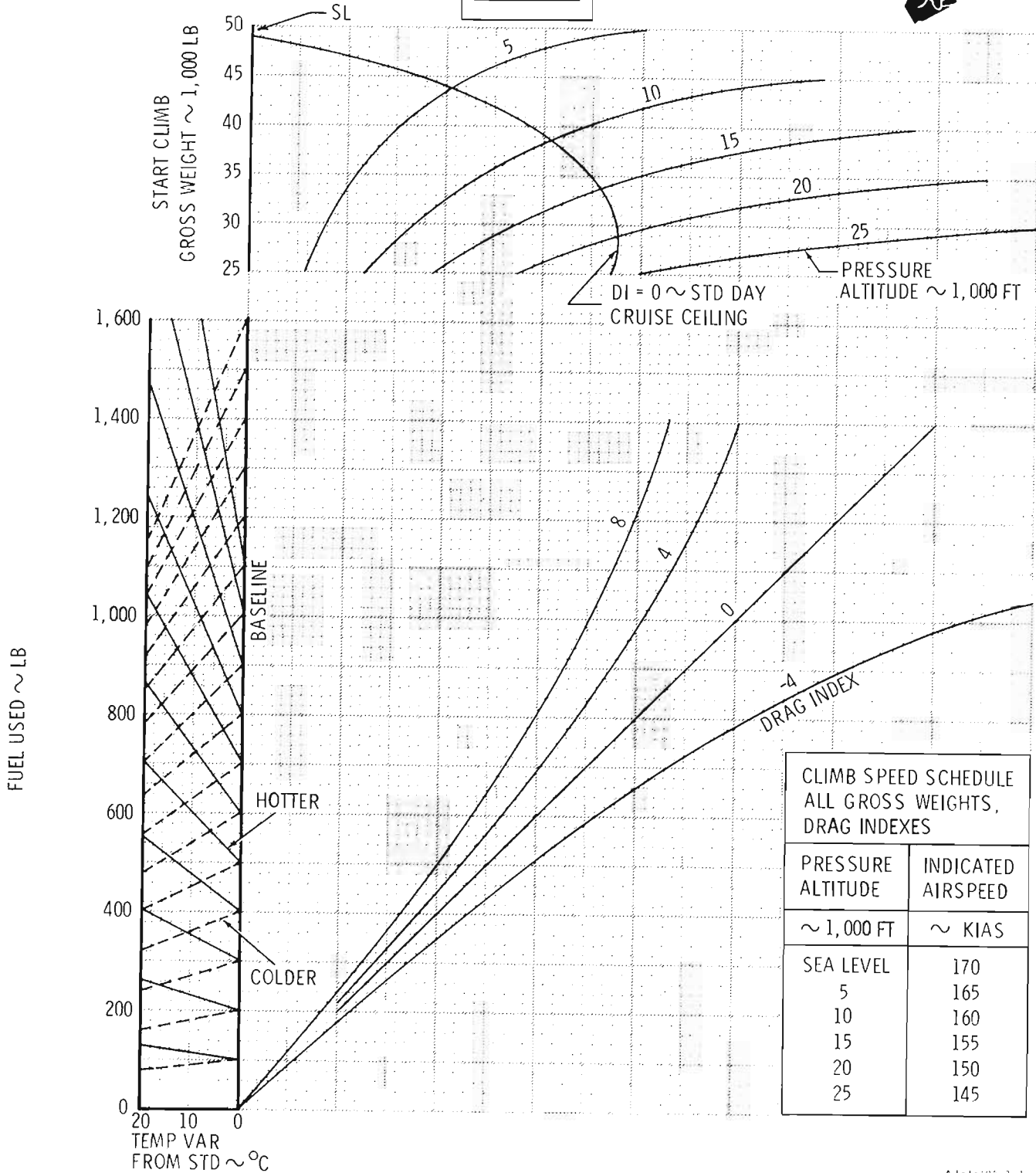

Figure A3-6

MAXIMUM THRUST CLIMB
Fuel Used and Speed Schedule
SINGLE-ENGINE
Failed Engine Windmilling



MODEL : A-10A
 DATE : 30 NOVEMBER 1982
 DATA BASIS : **A . F . FLIGHT TEST**
 ENGINES : (2) TF34-GE-100/100A



A1-1-10A-3-7

Figure A3-7 (Sheet 1 of 2)

MODEL : A-10A
 DATE : 30 NOVEMBER 1982
 DATA BASIS : A.F. FLIGHT TEST
 ENGINES : (2) TF34-GE-100/-100A

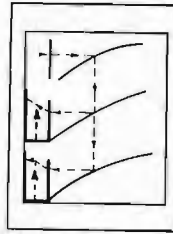

MAXIMUM THRUST CLIMB
Time and Distance
SINGLE-ENGINE
Failed Engine Windmilling

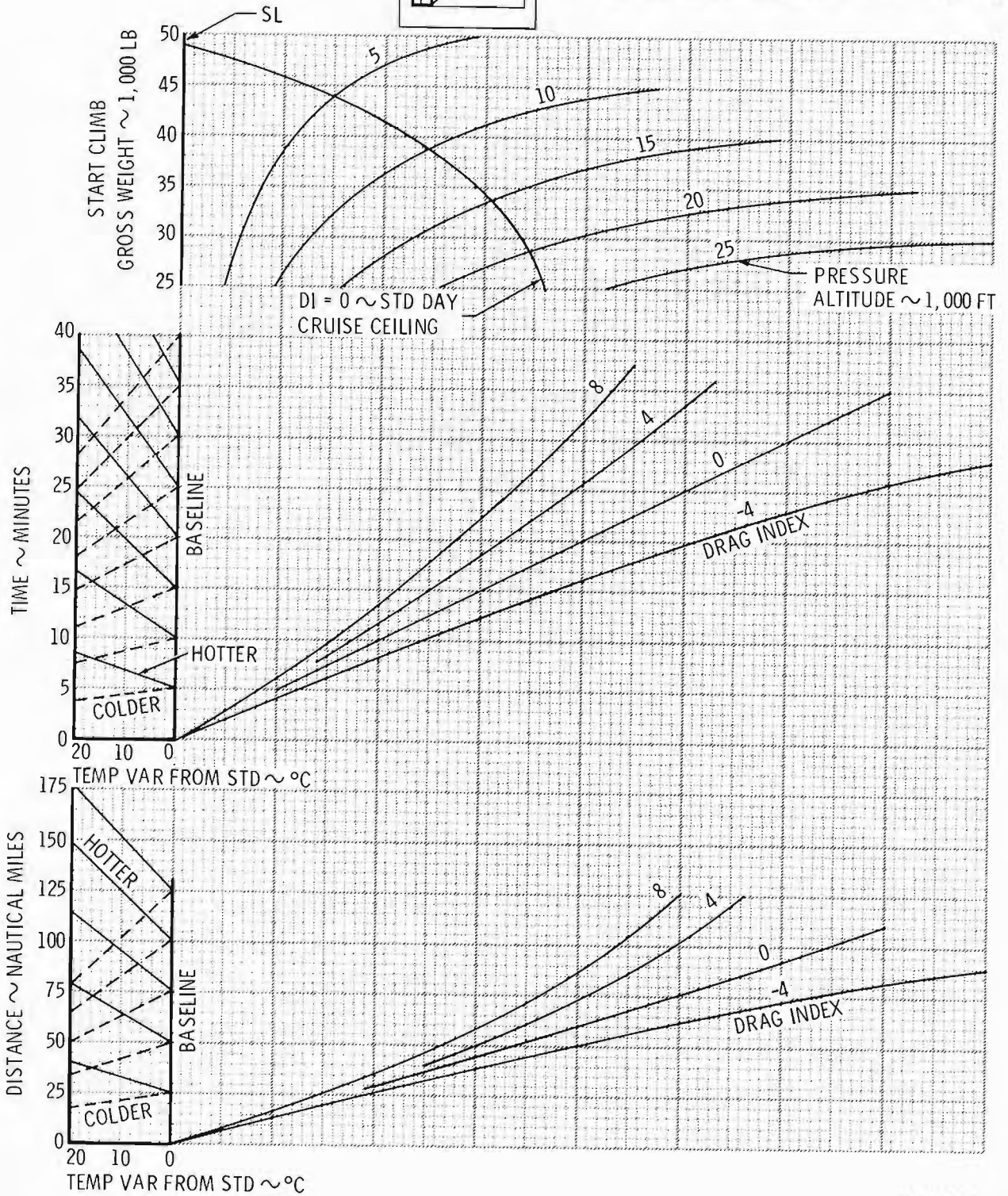

A1-1-10A-3-8

Figure A3-7 (Sheet 2 of 2)

CRUISE CEILING (300 FPM)
Maximum Thrust
SINGLE-ENGINE
Failed Engine Windmilling

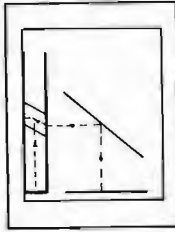

MODEL : A-10A
DATE : 30 NOVEMBER 1982
DATA BASIS : A . F. FLIGHT TEST
ENGINES : (2) TF34-GE-100/-100A

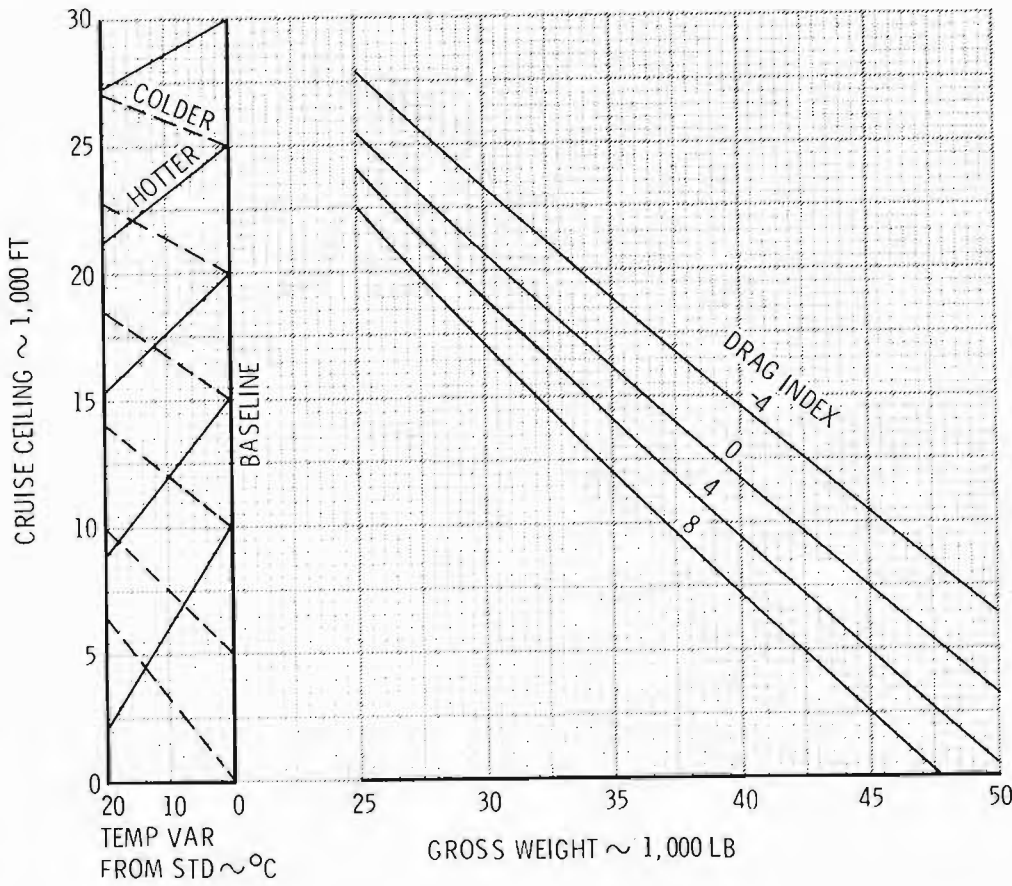

A1-1-10A-3-11

Figure A3-8

MODEL : A-10A
 DATE : 30 NOVEMBER 1982
 DATA BASIS : A . F . FLIGHT TEST
 ENGINES : (2) TF34-GE-100/-100A

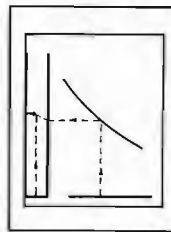

SERVICE CEILING (100 FPM)
Maximum Thrust
SINGLE-ENGINE
Failed Engine Windmilling

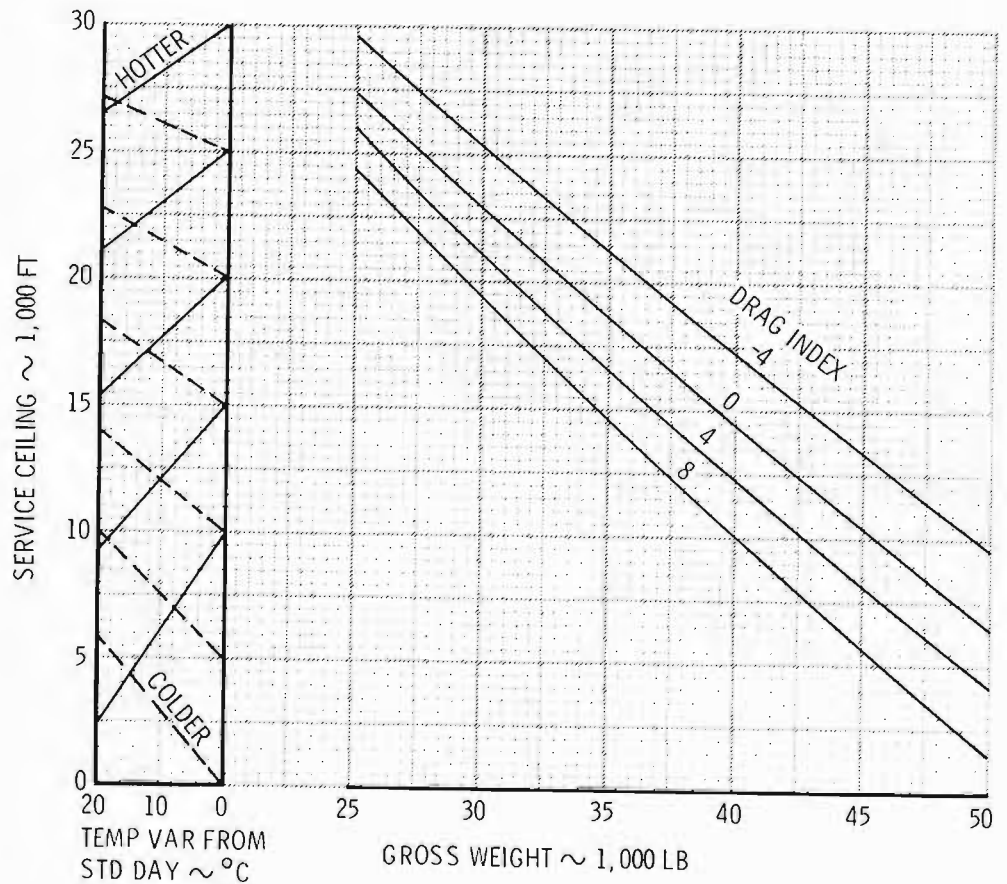

Figure A3-9

PART IV

RANGE

TABLE OF CONTENTS

	<u>Page</u>
Range Charts (General).....	A4-1
Definitions	A4-1
Optimum Cruise Altitude for Short Range Missions	A4-1
Optimum Cruise Altitude Charts	A4-2
Constant Altitude Cruise Charts	A4-3
Fuel Flow and Specific Range Charts	A4-5
Diversion Range Summary Tables	A4-7

LIST OF CHARTS

<u>Figure</u>		<u>Page</u>
A4-1	Optimum Cruise Altitude for Short Range Missions	A4-8
A4-2	Optimum Cruise Altitude	A4-9
A4-3	Constant Altitude Cruise	A4-10
A4-4	Fuel Flow and Specific Range	A4-12
A4-5	Optimum Cruise Altitude (Single-Engine)	A4-15
A4-6	Constant Altitude Cruise (Single-Engine)	A4-16
A4-7	Fuel Flow and Specific Range (Single-Engine)	A4-18
A4-8	Diversion Range Summary	A4-21

RANGE CHARTS (GENERAL)

The range charts provide the means of determining the optimum conditions under which the aircraft can be operated during cruise to obtain the maximum distance per pound of fuel, or conversely, to determine the feasibility of operation under a given set of conditions. Cruise data may be obtained for the initial cruise, average, or any aircraft gross weight.

DEFINITIONS

MAXIMUM RANGE CRUISE SPEED

The airspeed for maximum range cruise is the speed at which 100% of the nautical miles per pound of fuel are attainable at the momentary gross weight and altitude. That is the airspeed corresponding to the maximum nautical miles per pound of fuel.

LONG RANGE CRUISE SPEED

The airspeed for long range cruise is that speed faster than the maximum range cruise speed which provides 99% of the maximum cruise range (99% of maximum nautical

miles per pound of fuel). This speed is used to decrease mission time without severe penalty to range.

OPTIMUM CRUISE ALTITUDE FOR SHORT RANGE MISSIONS

For a short range mission, the cruise altitude may optimize at a lower altitude than is required for a long range mission. The optimum cruise altitude for short range missions chart, figure A4-1, presents the cruise altitude for short range missions as a function of the climb-plus-cruise-plus-descent distance, start climb gross weight, and drag index. If the intersection of the drag index and mission range distance plot falls outside the dashed "Use Optimum Cruise Altitude" line, obtain optimum cruise altitude from figure A4-2.

DIRECTIONS FOR USE OF CHART

Enter the chart with drag index and proceed to the right to the desired mission range distance, then drop down to the start climb gross weight. From this point, proceed to the left to read pressure altitude for cruise.

Sample Problem

Given:

- A. Drag index = 2
- B. Mission range distance = 150 NM
- C. Start climb gross weight = 40,000 lb

Calculate:

- A. Optimum cruise altitude
- B. Use optimum cruise altitude for short range missions chart, figure A4-1
 - 1. Drag index 2
 - 2. Mission range 150 NM
 - 3. Start climb gross weight 40,000 lb
 - 4. Pressure altitude for cruise 21,000 ft

OPTIMUM CRUISE ALTITUDE CHARTS

The optimum cruise altitude charts are presented on figures A4-2 and A4-5 for dual- and single-engine operation, respectively. These charts provide the optimum cruise altitudes for maximum range cruise as a function of the gross

weight at altitude, drag index, and temperature variation from standard day conditions.

DIRECTIONS FOR USE OF CHARTS

Enter the appropriate chart with gross weight at altitude, proceed up to the drag index, and then to the left to the temperature baseline. If standard day temperature exists, pass directly through the correction grid to read the optimum cruise pressure altitude. If not, contour the nearest appropriate guideline (hotter or colder) to the temperature variation and then move to the left to read pressure altitude.

Sample Problem

Given:

- A. Gross weight (at altitude) = 40,000 lb
- B. Drag index = 2
- C. Standard day -10°C temperature

Calculate:

- A. Optimum cruise altitude for dual-engine operation, standard day -10°C conditions

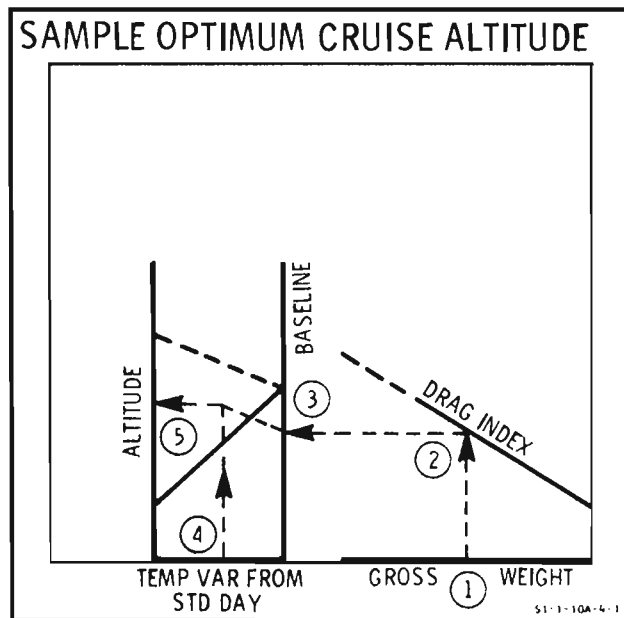
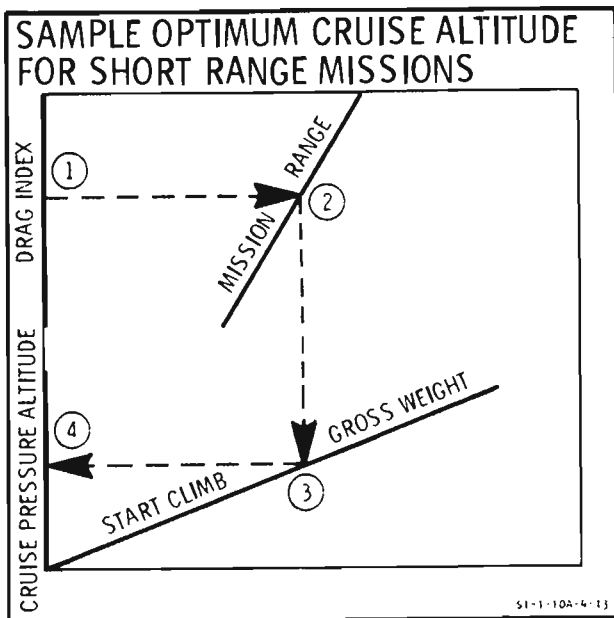

B. Use optimum cruise altitude chart, figure A4-1

- | | |
|-------------------------------|-----------|
| 1. Gross weight | 40,000 lb |
| 2. Drag index | 2 |
| 3. Go to temperature baseline | |
| 4. Temperature variation | -10°C |
| 5. Pressure altitude | 30,000 ft |

CONSTANT ALTITUDE CRUISE CHARTS

The constant altitude cruise charts for dual-engine operation (figure A4-3, sheets 1 and 2) and for single-engine operation (figure A4-6, sheets 1 and 2) provide cruise data based on long range cruise speeds. Long range cruise speed trades 1% of maximum range for an approximate 10% increase in speed.

Sheet 1 provides long range cruise speed (true Mach number) as a function of gross weight, pressure altitude, and drag index. The long range cruise Mach number can be converted to calibrated airspeed using the airspeed conversion chart (figure A1-5). The remainder of sheet 1 is an aid in obtaining values of true airspeed or ground speed and time as a function of true Mach number, temperature, and ground distance. Sheet 2 provides specific range (nautical miles per pound of fuel) as a function of gross weight, pressure altitude, and drag index. Fuel flow and fuel required may be obtained from the remainder of the chart as a function of specific range, true airspeed, and time. The values of true airspeed and time are obtained from sheet 1.

The constant altitude cruise charts should be used for mission planning when maximum range long range capability is desired, and the fuel flow and specific range charts

(figures A4-4 and A4-7) should be used when other than these cruise speeds are required.

DIRECTIONS FOR USE OF CHARTS

Enter sheet 1 with cruise gross weight, proceed right to the cruise pressure altitude, down to drag index, then left and read long range true Mach number. The long range cruise Mach number can be converted to calibrated airspeed using figure A1-5. At this value of true Mach number, proceed right to the temperature baseline and parallel the nearest guideline to the temperature applicable to the cruise altitude. Continue right from this point to the zero wind line, and at this position read the true airspeed on the scale at the bottom of the chart. Correct the airspeed to ground speed by moving left (for headwind) or right (for tailwind) by the amount of the wind, and read the ground speed on the same scale at the bottom of the chart. Move vertically up at the correct value of ground speed to the ground distance curve applicable to cruise (interpolate, if necessary), then left and read the time to cruise.

Enter sheet 2 with cruise gross weight, move right to cruise pressure altitude, and then down to the drag index. At this point, move left and read nautical miles-per-pound of fuel (specific range). At this value of specific range, proceed right to the true airspeed curve (interpolate, if necessary), then proceed up, noting the values of fuel flow, and continue up to the time required for cruise obtained from sheet 1. From this point, move left and read fuel required for cruise.

When the cruise gross weight is not known initially, it may be necessary to run through the charts once to obtain a value of cruise fuel based on the initial cruise weight and then reread the charts using the initial cruise weight reduced by half of the fuel found for cruise.

Sample Problem

Given:

- A. Gross weight = 35,500 lb
- B. Cruise pressure altitude = 20,000 ft
- C. Drag index = 0
- D. Temperature at altitude = -10°C
- E. Headwind = 25 kt
- F. Ground distance = 200 NM

Calculate:

A. Long range cruise speed, true airspeed, ground speed, time required, specific range, fuel flow, and fuel required

B. Use constant altitude cruise chart, figure A4-3, sheet 1

- 1. Gross weight 35,500 lb
- 2. Pressure altitude 20,000 ft
- 3. Drag index 0
- 4. True Mach number 0.433
- 5. Calibrated airspeed (from figure A1-5) 196 KCAS

- 6. Go to temperature baseline
- 7. Temperature at altitude -10°C
- 8. True airspeed (zero wind) 273 KTAS
- 9. Headwind 25 kt
- 10. Ground speed 248 kt
- 11. Ground distance 200 NM
- 12. Time required 48.4 min

C. Use constant altitude cruise chart, figure A4-3, sheet 2

- 1. Average gross weight 35,500 lb
- 2. Pressure altitude 20,000 ft
- 3. Drag index 0
- 4. Specific range 0.110 NM/lb
- 5. True airspeed 273 KTAS
- 6. Fuel flow 2,482 lb/hr

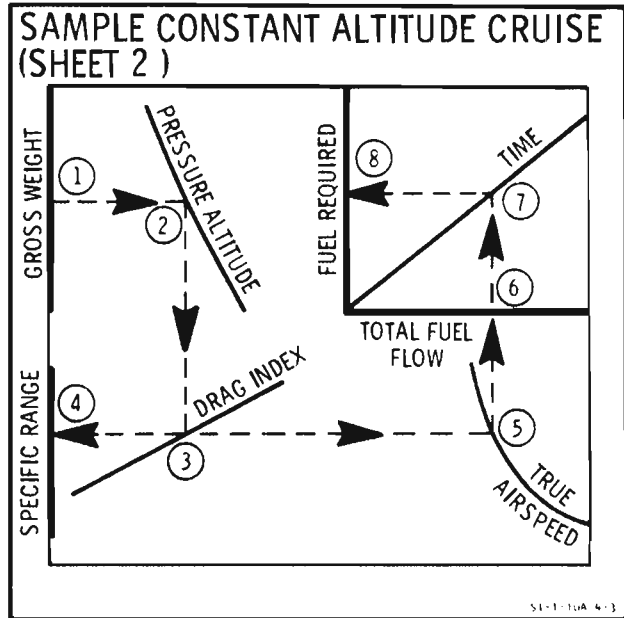
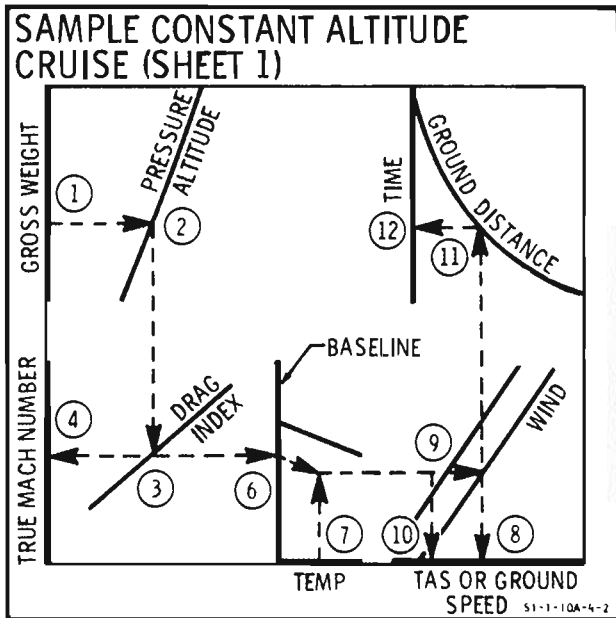

- | | |
|------------------|----------|
| 7. Time | 48.4 min |
| 8. Fuel required | 2,002 lb |

FUEL FLOW AND SPECIFIC RANGE CHARTS

The fuel flow and specific range charts provide cruise data throughout the speed range from approximately maximum endurance speed to maximum level flight speed. Charts are provided for both dual-engine and single-engine operation. These charts are used when the cruise speed is other than long range cruise speed.

The three fuel flow and specific range charts for dual-engine operation are presented on figure A4-4, sheets 1 through 3. Sheet 1 is used to obtain a reference number that, when used in sheet 2, provides specific range for the particular conditions of the flight. In sheet 3, cruise Mach number and temperature define true airspeed, which, when combined with specific range, yields total fuel flow. The single-engine charts, presented on figure A4-7, sheets 1 through 3, are identical in format and are used in the same manner as the dual-engine charts.

DIRECTIONS FOR USE OF CHARTS

Using the appropriate set of charts, enter sheet 1 with cruise gross weight, move right to the cruise pressure altitude, and then down through the true Mach number scale directly to the baseline. From this point of intersection with the baseline, contour the guideline either to the left or to the right to the desired cruise true Mach number projected down from the true Mach number scale. At this point of intersection, proceed to the right with a projection line through the reference number grid plot. Now, enter the upper right portion of the chart with the cruise true Mach number, move to the right to the appropriate drag index, and then proceed down to intersect the horizontal projection that was plotted previously through the reference number grid. At this intersection, read the value of reference number for use with sheet 2.

Enter sheet 2 with the true Mach number and proceed to the right to the reference number curve for the reference number value obtained in sheet 1 (interpolation may be required). From this intersection, move up to the cruise pressure altitude, and then to the left to read nautical miles per pound (specific range).

Enter sheet 3 with the cruise true Mach number, proceed to the right to the temperature curve applicable to the cruise pressure altitude, and then move up to read the true airspeed. Continue up from this true airspeed to the nautical miles per pound (specific range) curve for the nautical miles per pound value obtained in sheet 2. From this intersection, move to the left and read the total fuel flow. A reference table is provided at the bottom of the chart for temperature vs pressure altitude based on a standard day.

Sample Problem

Given:

- A. Gross weight = 35,000 lb
- B. Cruise pressure altitude = 25,000 ft
- C. Desired cruise speed = 200 KCAS
- D. Desired cruise true Mach number (from figure A1-5) = 0.488
- E. Drag index = 4.0
- F. Temperature at altitude = Std day (-34.5°C)

Calculate:

- A. Reference number, specific range, fuel flow, and true airspeed
- B. Use fuel flow and specific range chart, figure A4-4, sheet 1

- | | |
|----------------------|-----------|
| 1. Gross weight | 35,000 lb |
| 2. Pressure altitude | 25,000 ft |

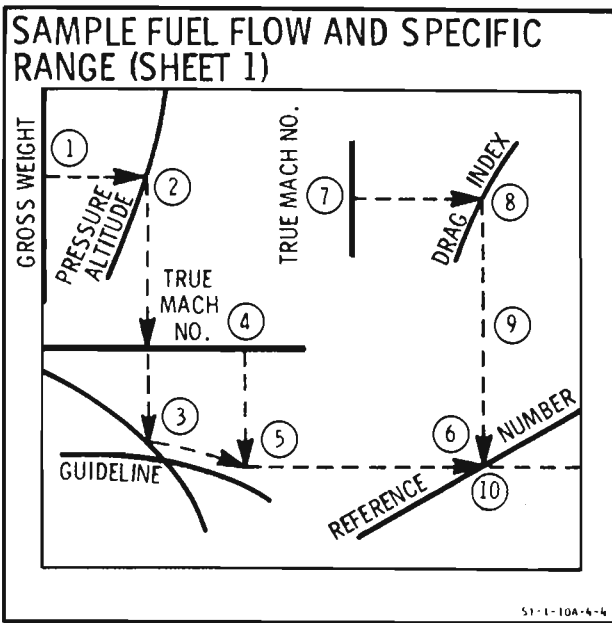

51-1-10A-4-4

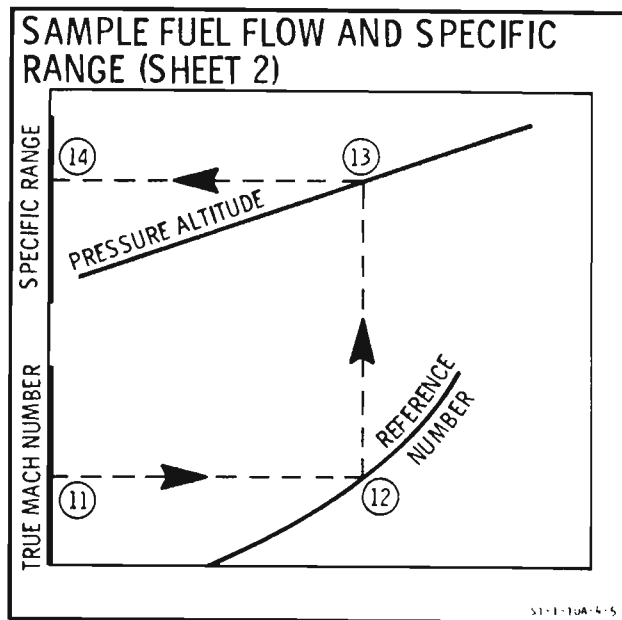

51-1-10A-4-5

3. Go to baseline
4. Mach number (desired cruise) 0.488
5. Intersect guideline contour
6. Projected line (through reference number grid)
7. Mach number 0.488
8. Drag index 4
9. Project line vertically down to intersect line from 6
10. Reference number 12.3

C. Use fuel flow and specific range chart, figure A4-4, sheet 2

11. True Mach number 0.488
12. Reference number 12.3
13. Pressure altitude 25,000 ft
14. Specific range 0.108 NM/lb

D. Use fuel flow and specific range chart, figure A4-4, sheet 3

15. True Mach number 0.488
16. Temperature -34.5 °C
17. True airspeed 293 KTAS
18. Specific range 0.108 NM/lb
19. Fuel flow 2,720 lb/hr

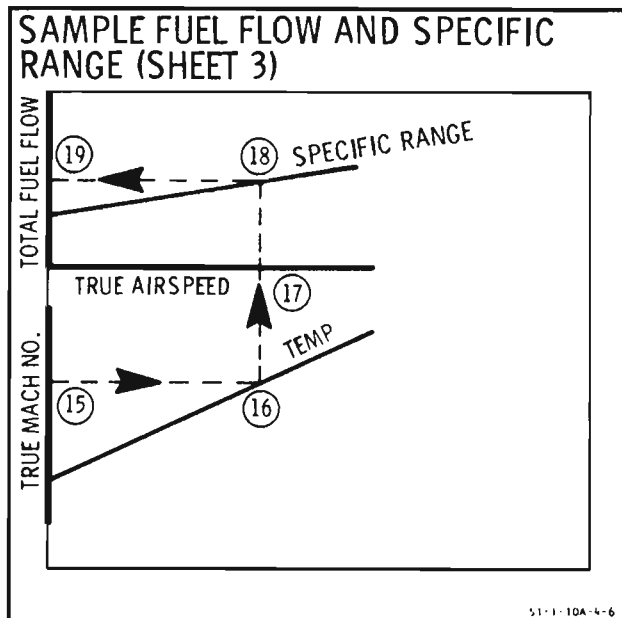

51-1-10A-4-6

DIVERSION RANGE SUMMARY TABLES

The diversion range summary tables are presented on figure A4-8, sheets 1 through 3 for configurations with drag index values of 0, 2, and 4, respectively. These tables provide, in quick reference form, the diversion range obtainable and time required to return to base or divert to an alternate base with 1,500, 2,000, 2,500, or 3,000 pounds of fuel remaining. The range and time are based on having 1,200 pounds of fuel remaining for approach and landing after the maximum range descent is completed. Range and time data are shown in the tables for two optional return/divert profiles, together with the optimum altitude for the cruise. The optimum altitude is the altitude that provides the maximum range for the particular type of flight profile used. Cruise speeds and descent information are provided at the bottom of the diversion range summary charts.

The two types of flight profiles are:

A. Cruise at initial altitude and descend on course to base at maximum range descent, idle thrust, and speed brakes closed.

B. Climb on course to optimum cruise altitude, cruise at optimum altitude, and descend on course to base at maximum range descent, idle thrust, and speed brakes closed.

DIRECTIONS FOR USE OF TABLES

Enter the appropriate table at initial altitude and fuel remaining, and then read the range and time available in the two flight profile options, noting the procedure to be followed for each option.

Sample Problem

Given:

A. Fuel remaining = 2,200 lb

B. Initial altitude = 25,000 ft

C. Drag index = 2

Calculate:

A. Diversion range information using diversion range summary table - drag index = 2, figure A4-8, sheet 2

1. Ranges with options available (use 25,000 ft column and 2,000 lb fuel remaining row)	129 NM 134 NM
2. Option selected (nearest value)	129 NM
3. Cruise altitude (remain at initial altitude)	25,000 ft
4. Cruise speed	168 KIAS
5. Cruise distance (on course)	85 NM
6. Descent distance (on course)	44 NM
7. Descent fuel	133 lb
8. Descent conditions	146 KIAS idle thrust speed brakes closed
9. Time required (no wind)	36 min
10. Fuel remaining (2,200 lb - 2,000 lb)	200 lb (approximately)
11. Fuel reserve	1,200 lb
12. Total fuel remaining	1,400 lb

**OPTIMUM CRUISE ALTITUDE
FOR SHORT-RANGE MISSIONS**
Standard Day

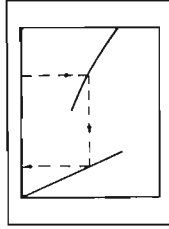

MODEL : A-10A
 DATE : 30 NOVEMBER 1982
 DATA BASIS : A . F. FLIGHT TEST
 ENGINES : (2) TF34-GE-100/-100A

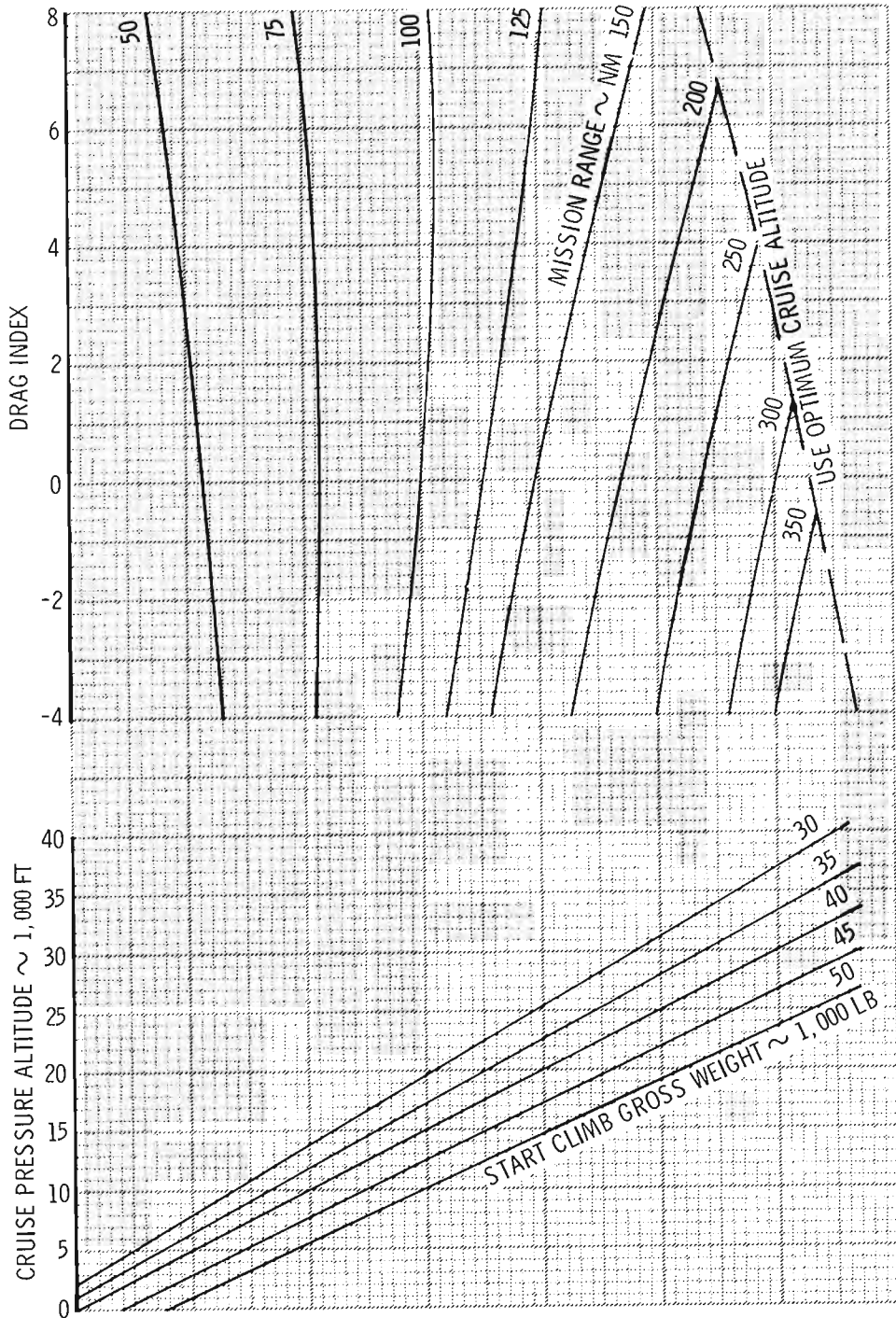

- CONDITIONS
- 775°C ITT thrust climb
 - Long range cruise
 - Penetration descent

A1-1-10A-4-13

Figure A4-1

MODEL : A-10A
 DATE : 30 NOVEMBER 1982
 DATA BASIS : **A.F. FLIGHT TEST**
 ENGINES : (2) TF34-GE-100/-100A

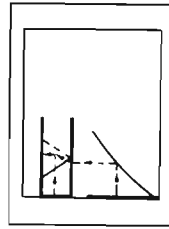

OPTIMUM CRUISE ALTITUDE

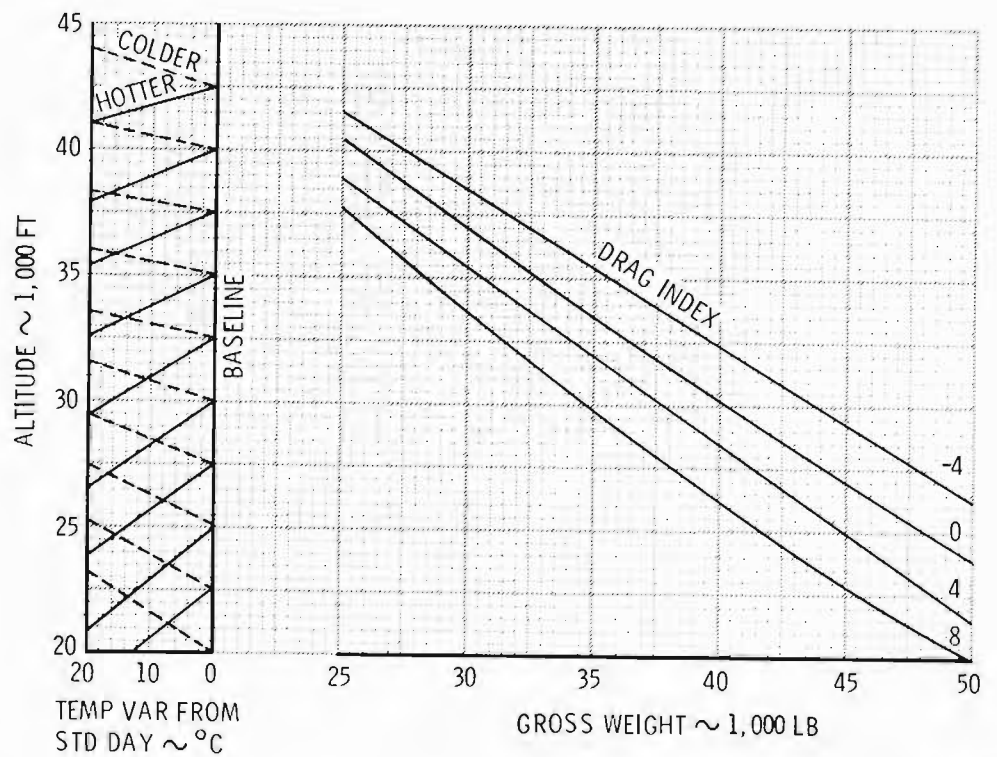

A 1-10A-1-1

Figure A4-2

CONSTANT ALTITUDE CRUISE
Long Range Speed, True Airspeed, Ground Speed, and Time

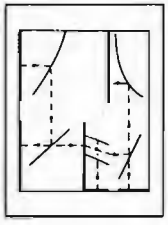

MODEL : A-10A
 DATE : 30 NOVEMBER 1982
 DATA BASIS : **A . F . FLIGHT TEST**
 ENGINES : (2) TF34-GE-100/-100A

NOTE
 For maximum range, reduce cruise Mach no. by 0.025'

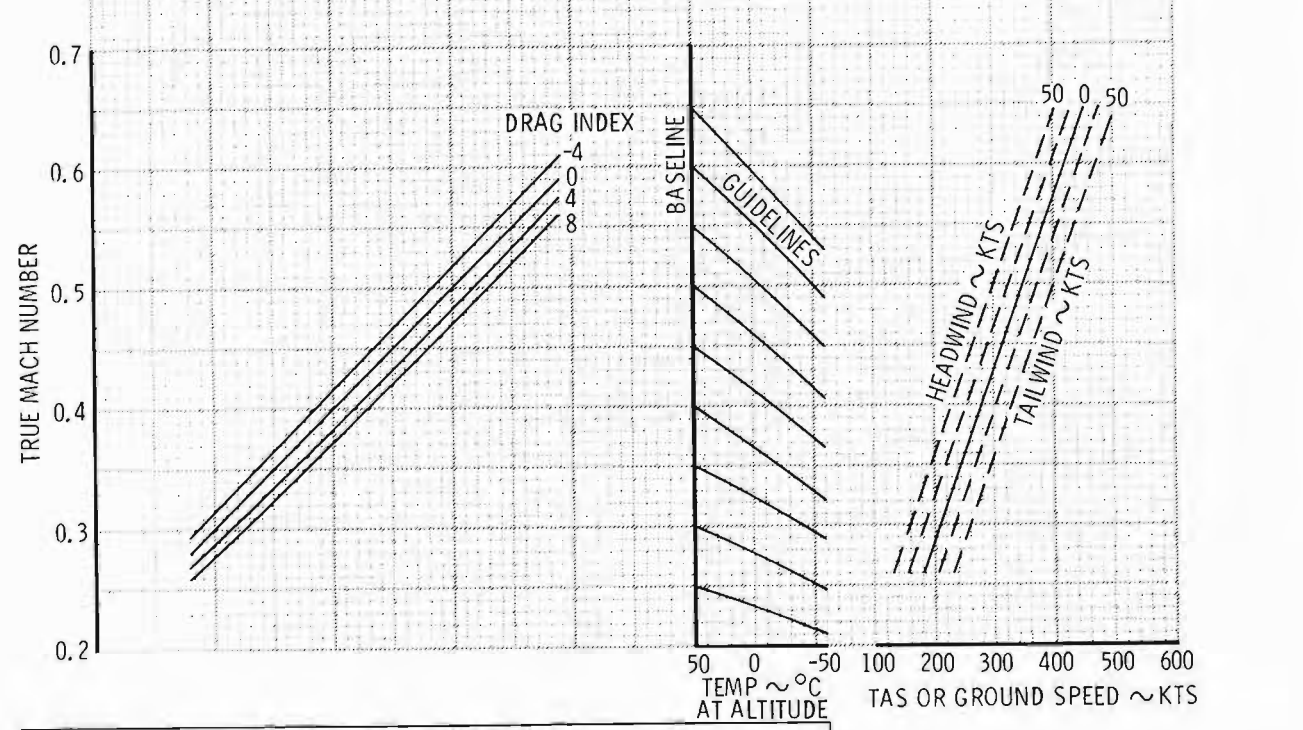
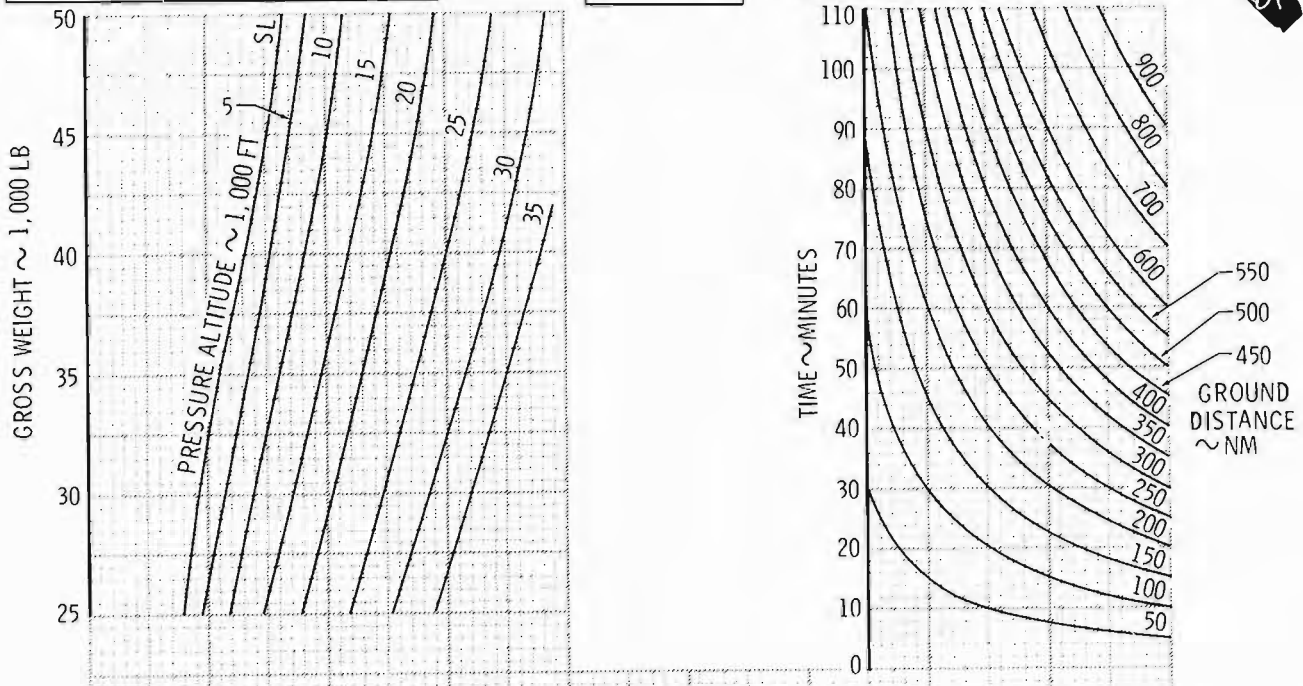

STANDARD DAY									
ALT ~ 1,000 FT	SL	5	10	15	20	25	30	35	36, 089 & ABOVE
TEMP ~ °C	15.0	5.1	-4.8	-14.7	-24.6	-34.6	-44.4	-54.3	-56.5

Figure A4-3 (Sheet 1 of 2)

MODEL : A-10A
 DATE : 30 NOVEMBER 1982
 DATA BASIS : A . F . FLIGHT TEST
 ENGINES : (2) TF34-GE-100/-100A

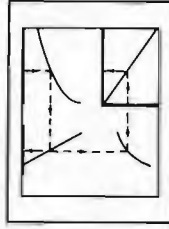

**CONSTANT ALTITUDE
 CRUISE
 Long Range Speed,
 Specific Range, Fuel Flow,
 and Fuel Required**

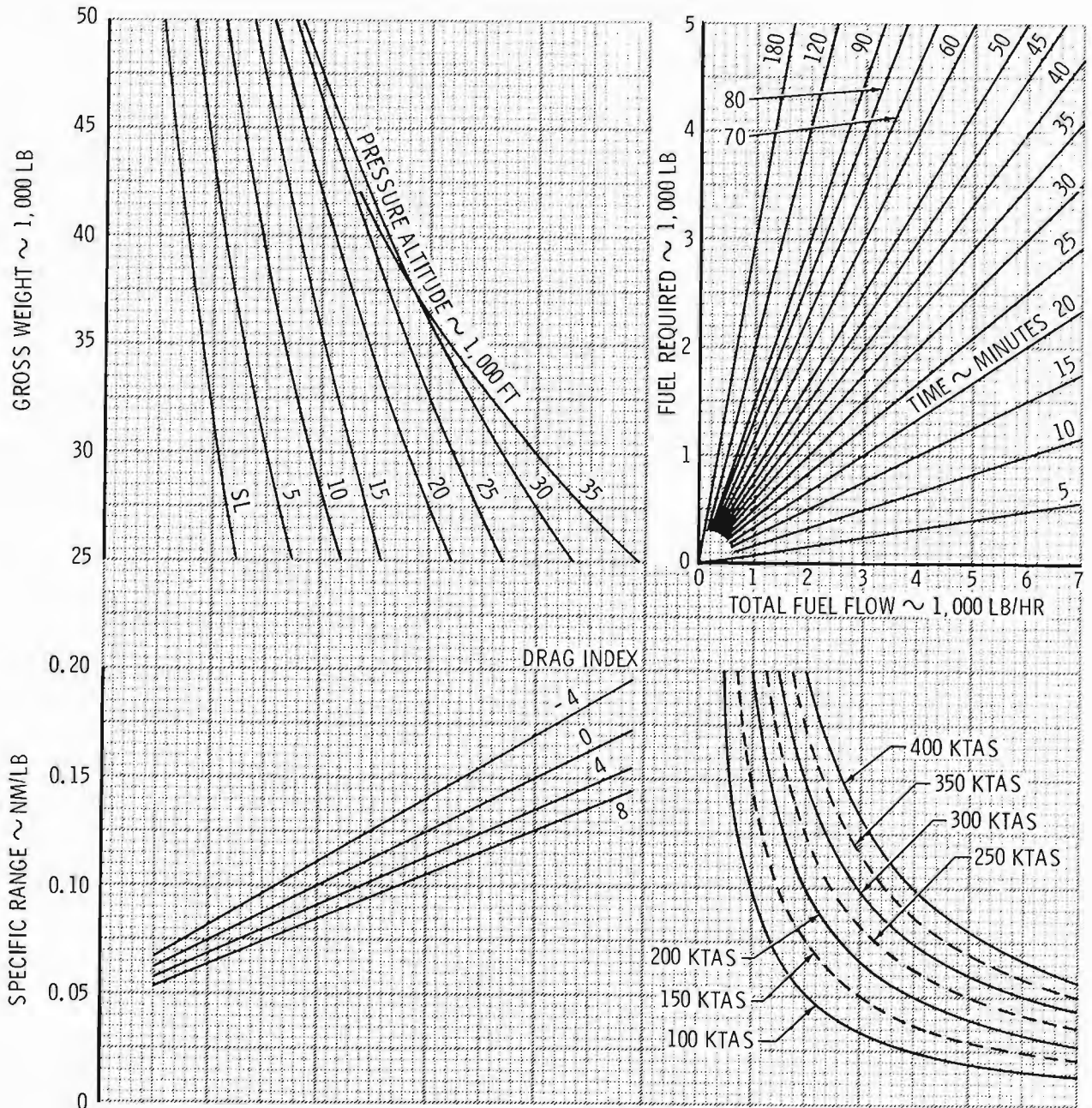

A1-1-10A-4-3

Figure A4-3 (Sheet 2 of 2)

**FUEL FLOW And
SPECIFIC RANGE
True Mach Number
and
Reference Number**

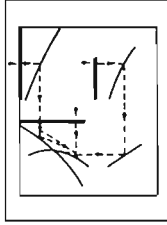

MODEL : A-10A
DATE : 30 NOVEMBER 1982
DATA BASIS : **A.F. FLIGHT TEST**
ENGINES : (2) TF34-GE-100/-100A

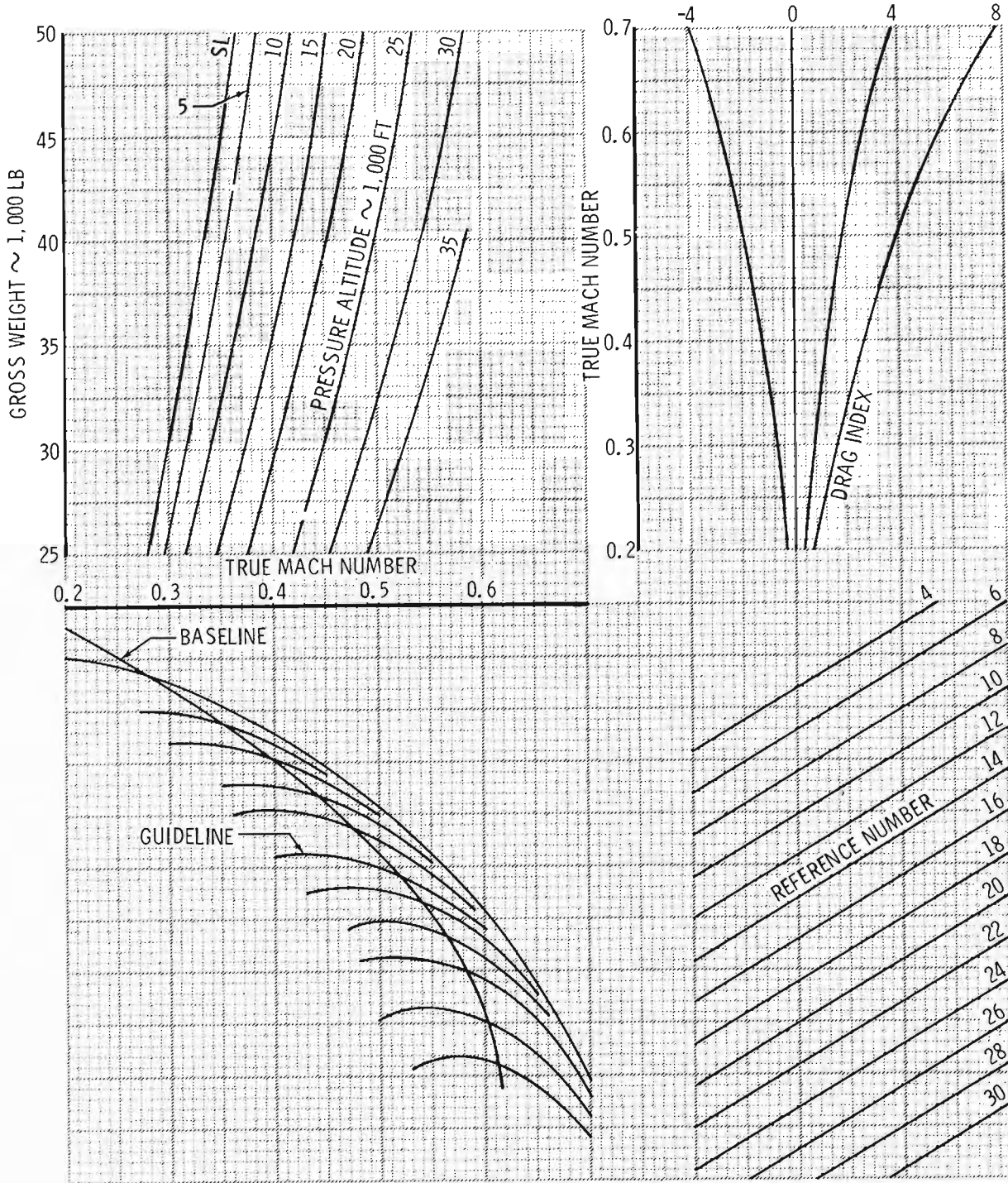

A1-1-10A-4-4

Figure A4-4 (Sheet 1 of 3)

MODEL : A-10A
DATE : 30 NOVEMBER 1982
DATA BASIS : A . F . FLIGHT TEST
ENGINES : (2) TF34-GE-100/-100A

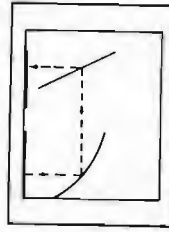

**FUEL FLOW And
SPECIFIC RANGE
Nautical Miles Per
Pound of Fuel**

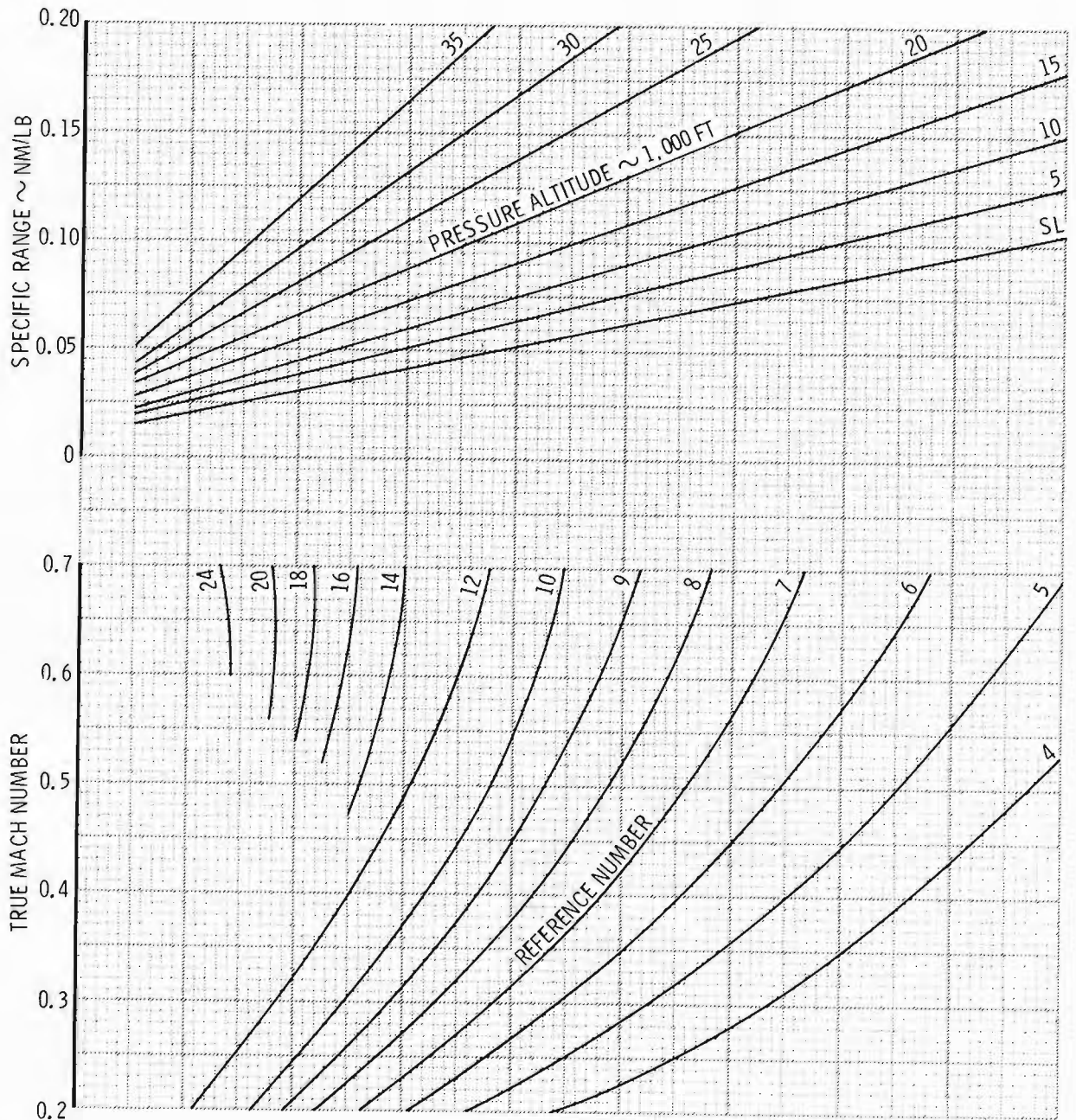

A1-1-10A-4-5

Figure A4-4 (Sheet 2 of 3)

**FUEL FLOW And
SPECIFIC RANGE
True Airspeed And
Fuel Flow**

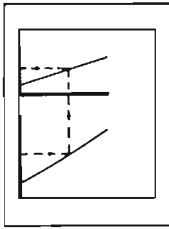

MODEL : A-10A
DATE : 30 NOVEMBER 1982
DATA BASIS : **A . F. FLIGHT TEST**
ENGINES : (2) TF34-GE-100i-100A

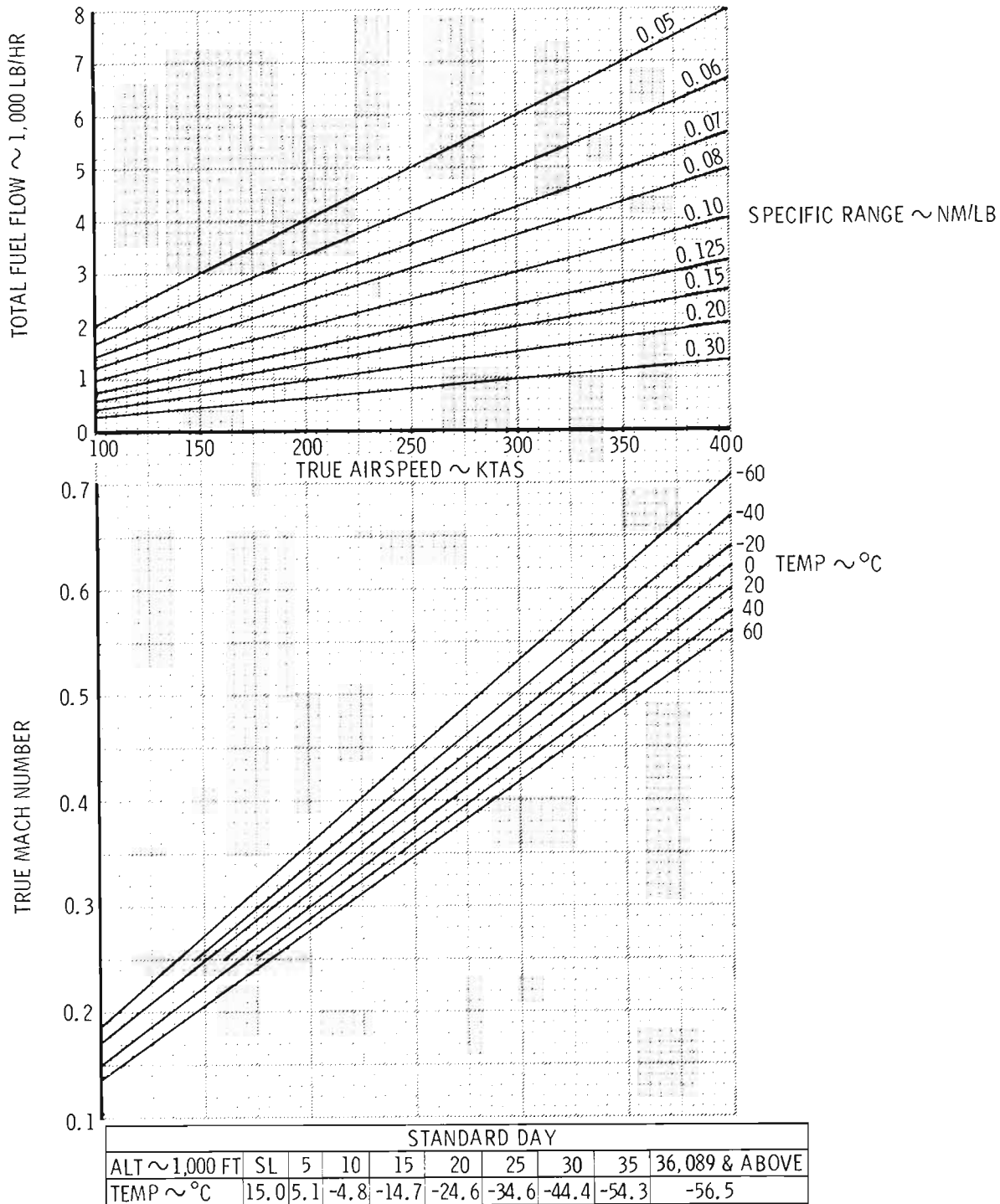

A1-1-10A-4-6

Figure A4-4 (Sheet 3 of 3)

MODEL : A-10A
DATE : 30 NOVEMBER 1982
DATA BASIS : **A . F . FLIGHT TEST**
ENGINES : (2) TF34-GE-100/-100A

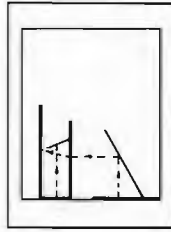

**OPTIMUM CRUISE
ALTITUDE
SINGLE-ENGINE
Failed Engine Windmilling**

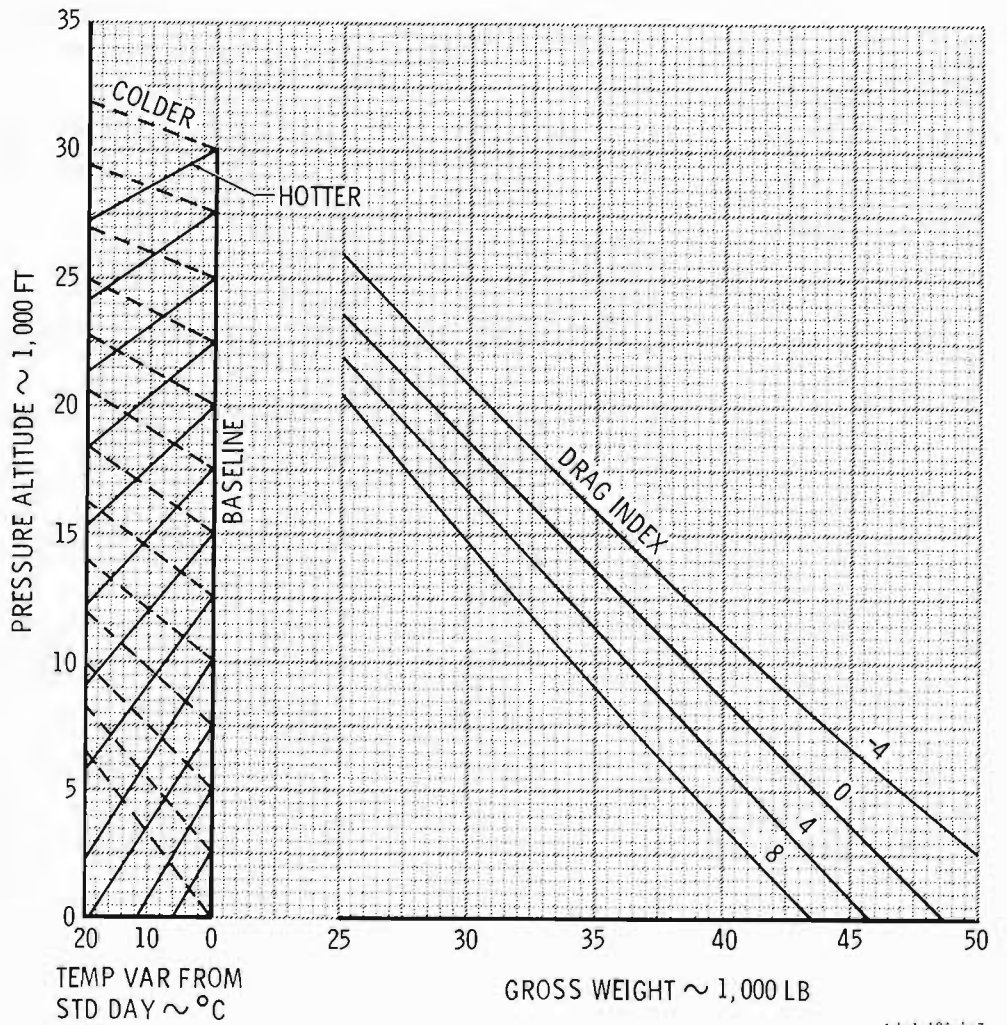

A 1-1-10A-4-7

Figure A4-5

CONSTANT ALTITUDE CRUISE
Long Range Speed, True Airspeed,
Ground Speed, and Time
SINGLE-ENGINE
Failed Engine Windmilling

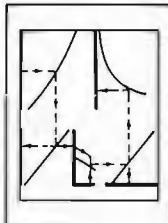

MODEL : A-10A
 DATE : 30 NOVEMBER 1982
 DATA BASIS : A.F. FLIGHT TEST
 ENGINES : (2) TF34-GE-100/-100A

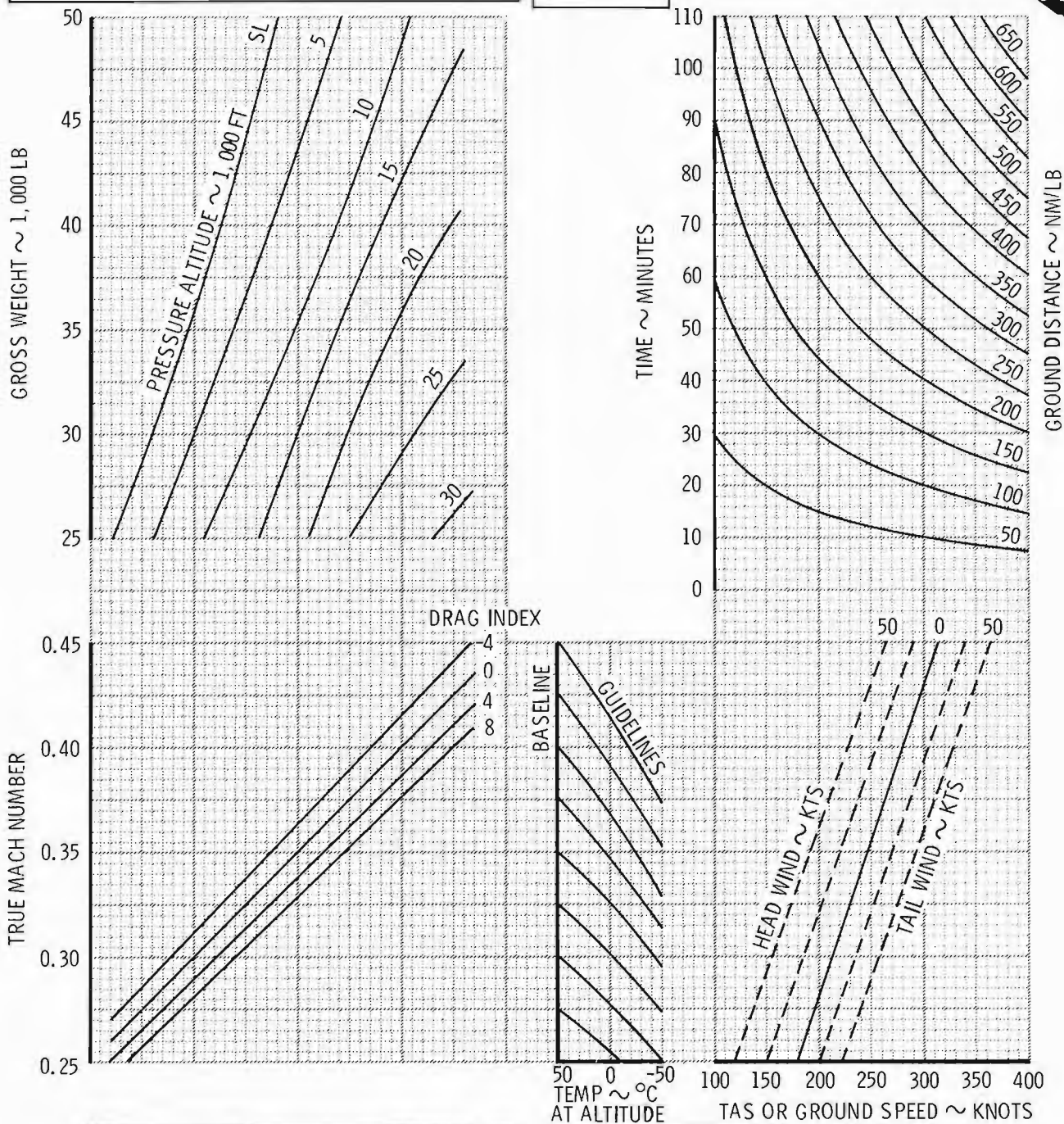

STANDARD DAY									
ALT ~ 1,000 FT	SL	5	10	15	20	25	30	35	36,089 & ABOVE
TEMP ~ °C	15.0	5.1	-4.8	-14.7	-24.6	-34.6	-44.4	-54.3	-56.5

A1-1-10A-4-8

Figure A4-6 (Sheet 1 of 2)

MODEL : A-10A
 DATE : 30 NOVEMBER 1982
 DATA BASIS : A . F . FLIGHT TEST
 ENGINES : (2) TF34-GE-100/-100A

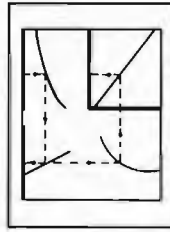

CONSTANT ALTITUDE CRUISE
Long Range Speed
Specific Range, Fuel Flow,
and Fuel Required
SINGLE-ENGINE
Failed Engine Windmilling

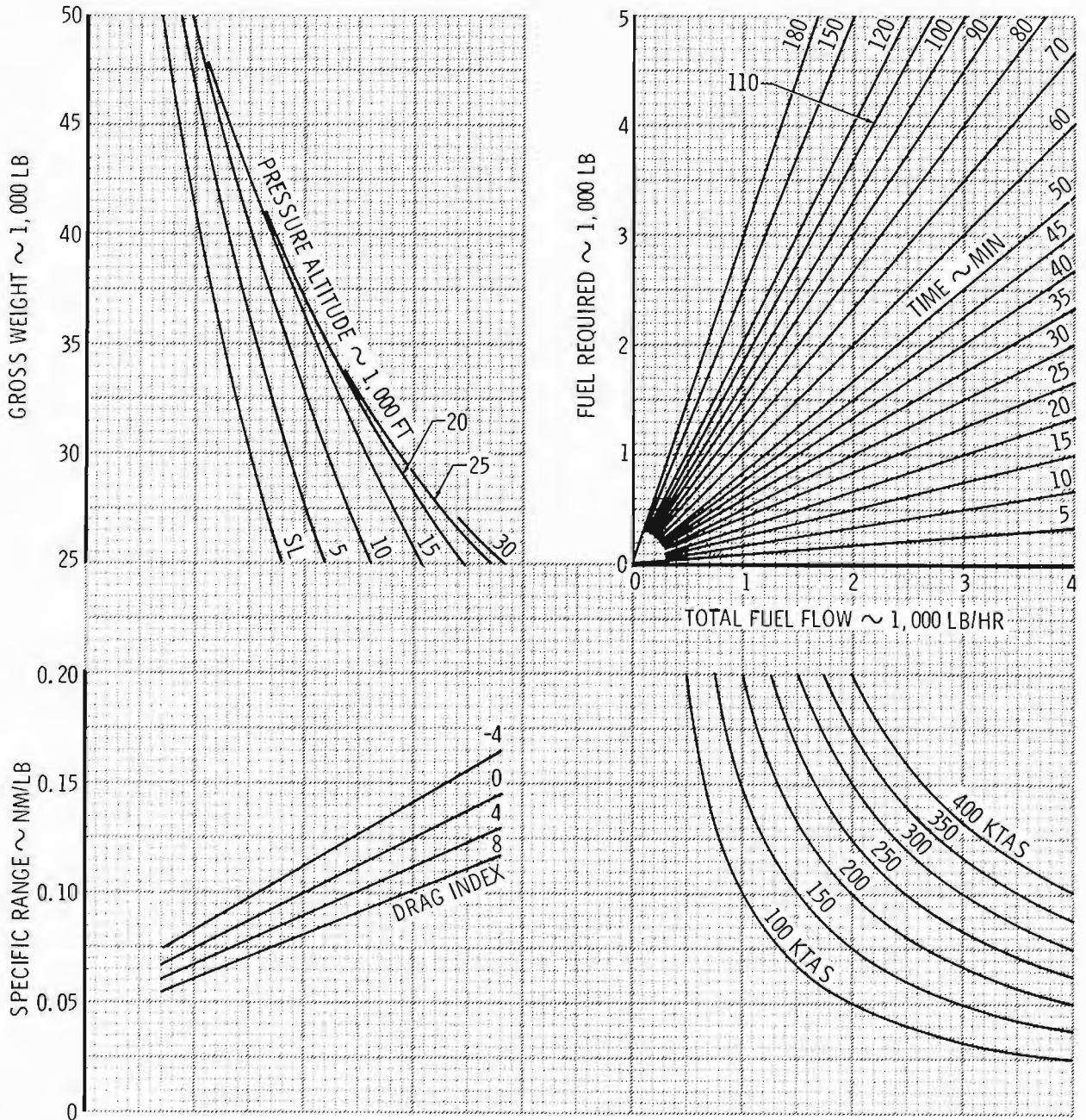

A 1-1-10A-4-9

Figure A4-6 (Sheet 2 of 2)

**FUEL FLOW And
SPECIFIC RANGE
True Mach Number and
Reference Number
SINGLE-ENGINE
Failed Engine Windmilling**

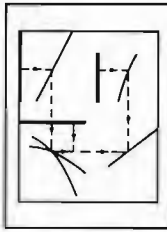

MODEL : A-10A
DATE : 30 NOVEMBER 1982
DATA BASIS : A . F . FLIGHT TEST
ENGINES : (2) TF34-GE-100/-100A

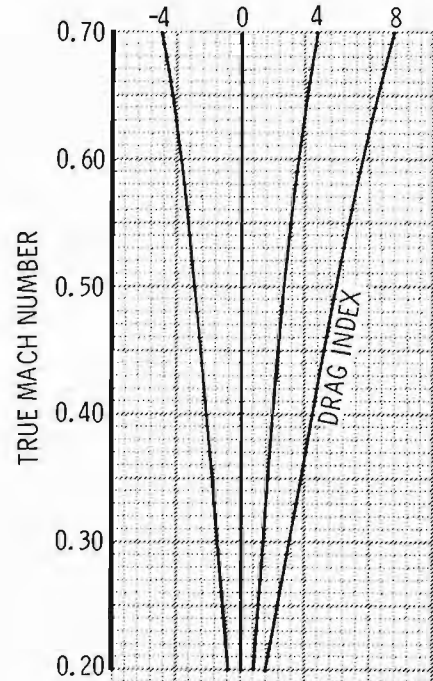
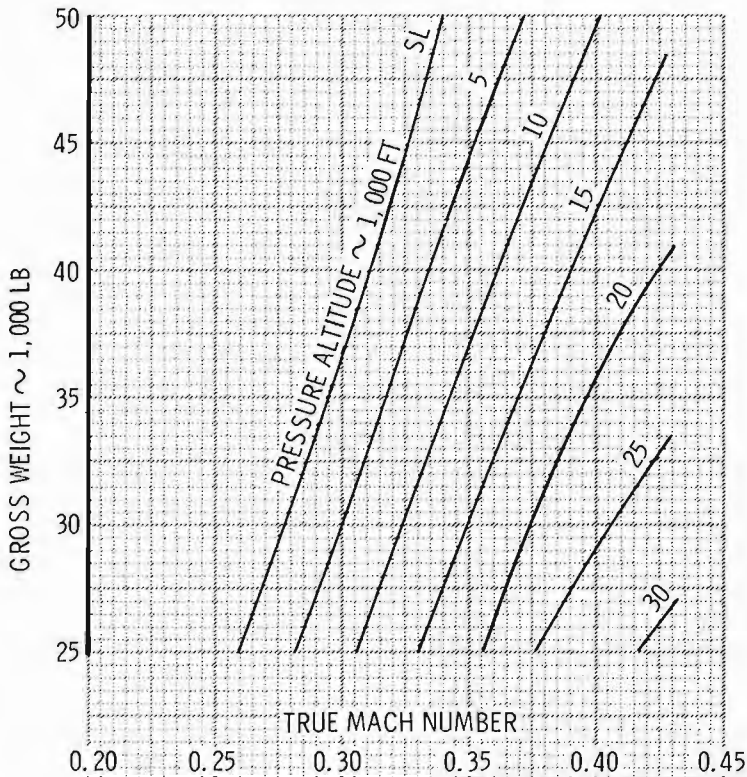

A1-1-10A-4-10

Figure A4-7 (Sheet 1 of 3)

MODEL : A-10A
DATE : 30 NOVEMBER 1982
DATA BASIS : A . F . FLIGHT TEST
ENGINES : (2) TF34-GE-100/-100A

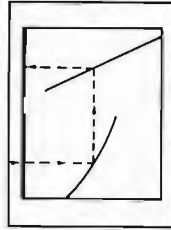

**FUEL FLOW And
SPECIFIC RANGE
Nautical Miles Per
Pound of Fuel
SINGLE-ENGINE
Failed Engine Windmilling**

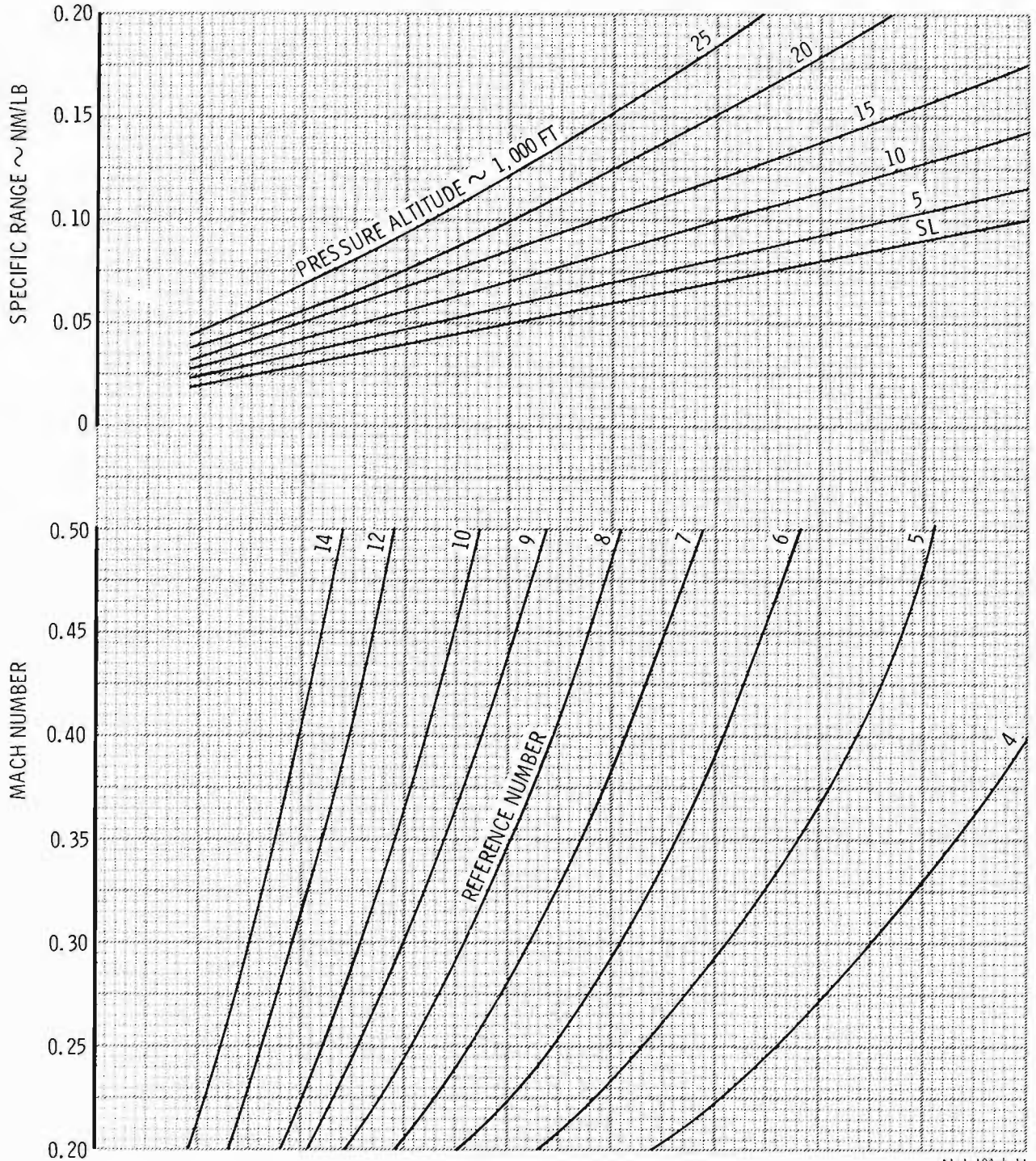

A1-1-10A-4-11

Figure A4-7 (Sheet 2 of 3)

MODEL : A-10A
 DATE : 30 NOVEMBER 1982
 DATA BASIS : A . F. FLIGHT TEST
 ENGINES : (2) TF34-GE-100/-100A



**FUEL FLOW And
 SPECIFIC RANGE
 True Airspeed And Fuel Flow
 SINGLE-ENGINE
 Failed Engine Windmilling**

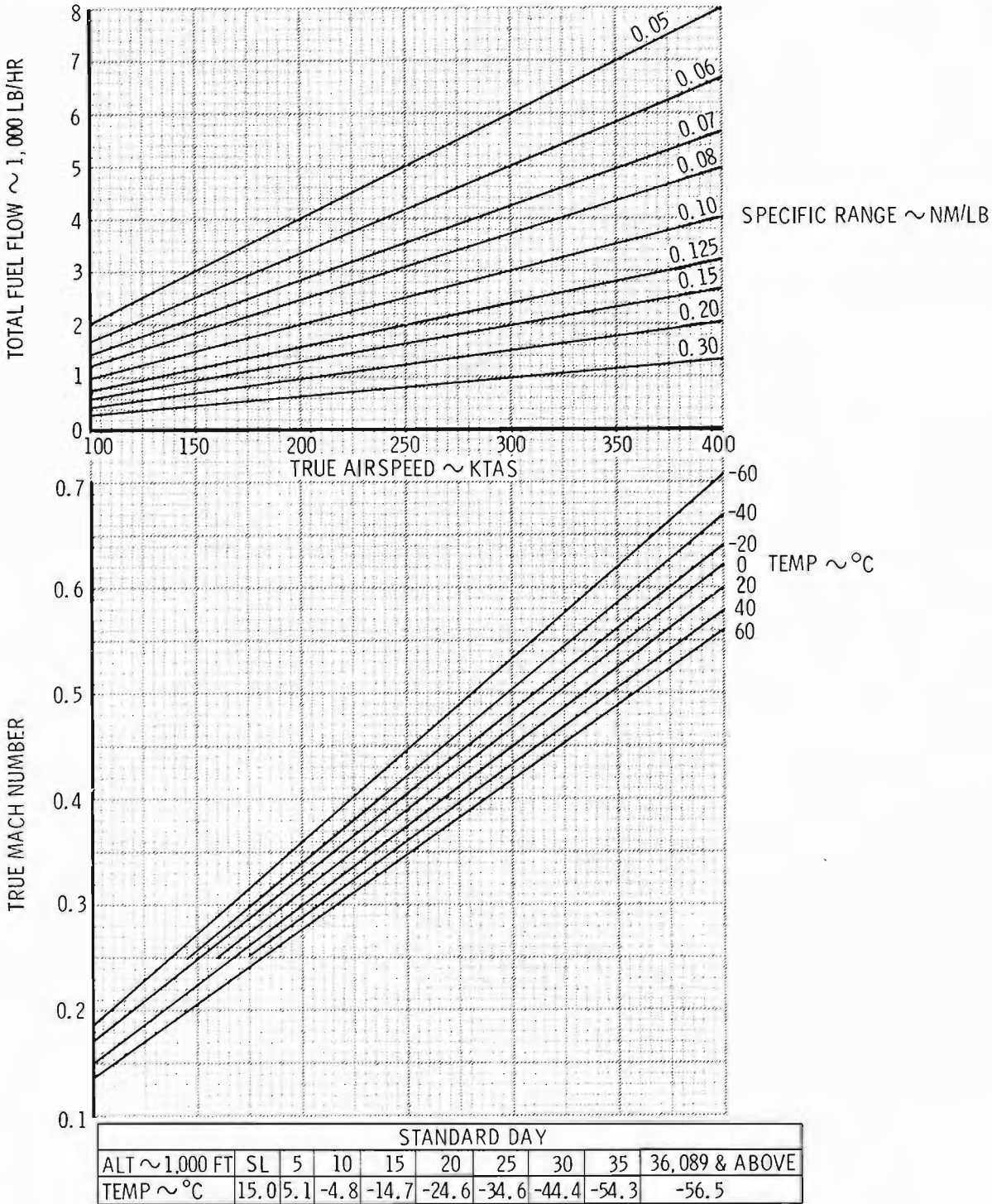
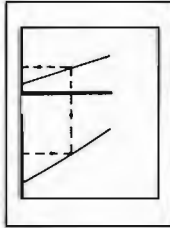

Figure A4-7 (Sheet 3 of 3)

DIVERSION RANGE SUMMARY
DRAG INDEX = 0
• STANDARD DAY
• NO WIND CONDITIONS

RANGE AND TIME WITH 1,200 LB FUEL REMAINING FOR APPROACH AND LANDING											
INITIAL ALTITUDE x 1,000		SL	5	10	15	20	25	30	35	OPTION	
FUEL REMAINING	1,500 LB	NM	24	33	42	50	60	68	77	86	CRUISE AT INITIAL ALTITUDE AND DESCEND ON COURSE
		MIN	8	12	15	17	20	22	24	26	
		FT x 1,000	10	15	15	20	20	25	30	35	OPTIMUM ALTITUDE
		NM	29	36	44	52	60	68	77	86	CLIMB TO OPTIMUM ALTITUDE AND DESCEND ON COURSE
		MIN	11	13	15	18	20	22	24	26	
	2,000 LB	NM	63	78	92	105	122	135	151	164	CRUISE AT INITIAL ALTITUDE AND DESCEND ON COURSE
		MIN	21	27	30	31	36	38	41	43	
		FT x 1,000	25	30	30	30	35	35	35	35	OPTIMUM ALTITUDE
		NM	89	99	110	121	131	142	153	164	CLIMB TO OPTIMUM ALTITUDE AND DESCEND ON COURSE
		MIN	28	31	33	35	37	39	41	43	
	2,500 LB	NM	102	123	142	160	183	202	224	241	CRUISE AT INITIAL ALTITUDE AND DESCEND ON COURSE
		MIN	34	41	46	46	52	54	58	60	
		FT x 1,000	35	35	35	35	35	35	35	35	OPTIMUM ALTITUDE
		NM	160	173	185	197	207	219	230	241	CLIMB TO OPTIMUM ALTITUDE AND DESCEND ON COURSE
		MIN	45	48	50	52	54	56	58	60	
	3,000 LB	NM	140	168	191	214	244	268	296	317	CRUISE AT INITIAL ALTITUDE AND DESCEND ON COURSE
		MIN	46	56	60	60	68	69	74	76	
		FT x 1,000	35	35	35	35	35	35	35	35	OPTIMUM ALTITUDE
		NM	236	249	261	273	284	295	306	317	CLIMB TO OPTIMUM ALTITUDE AND DESCEND ON COURSE
		MIN	62	64	66	68	70	72	74	76	
CRUISE ALT FT x 1,000		SL	5	10	15	20	25	30	35	CRUISE AT MAX RANGE AOA ~15.6 UNITS	
CRUISE SPEED - KIAS		185	178	176	174	172	170	168	164		
CRUISE FF ~100 LB/HR		23.6	21.1	20.3	19.8	18.9	18.8	18.4	18.6		
DESCENT DIST - NM		-	9	18	27	37	47	58	69	DESCEND AT 144 KIAS SPEED BRAKES CLOSED, IDLE THRUST	
DESCENT FUEL - LB		-	31	60	89	116	142	167	191		

- FUEL, TIME, AND DISTANCE INCLUDED FOR CLIMB TO OPTIMUM ALTITUDE, CRUISE, AND ON-COURSE MAXIMUM RANGE DESCENT TO SEA LEVEL DESTINATION.

Figure A4-8 (Sheet 1 of 3)

DIVERSION RANGE SUMMARY
DRAG INDEX = 2
 • **STANDARD DAY**
 • **NO WIND CONDITIONS**

RANGE AND TIME WITH 1,200 LB FUEL REMAINING FOR APPROACH AND LANDING											
INITIAL ALTITUDE x 1,000		SL	5	10	15	20	25	30	35	OPTION	
FUEL REMAINING	1,500 LB	NM	22	32	40	48	57	66	74	82	CRUISE AT INITIAL ALTITUDE AND DESCEND ON COURSE
		MIN	8	11	14	16	19	21	23	25	
		FT x 1,000	10	15	15	20	20	25	30	35	OPTIMUM ALTITUDE x 1,000 FT
		NM	27	35	42	50	57	66	74	82	CLIMB TO OPTIMUM ALTITUDE AND DESCEND ON COURSE
		MIN	10	13	15	17	19	21	23	25	
	2,000 LB	NM	60	74	88	101	116	129	143	154	CRUISE AT INITIAL ALTITUDE AND DESCEND ON COURSE
		MIN	20	25	28	31	34	36	39	40	
		FT x 1,000	25	25	30	30	30	30	30	35	OPTIMUM ALTITUDE
		NM	83	93	104	114	124	134	143	154	CLIMB TO OPTIMUM ALTITUDE AND DESCEND ON COURSE
		MIN	26	39	31	33	36	37	39	40	
	2,500 LB	NM	97	117	135	153	174	191	211	225	CRUISE AT INITIAL ALTITUDE AND DESCEND ON COURSE
		MIN	33	39	43	45	49	51	55	55	
		FT x 1,000	30	30	30	30	35	35	35	35	OPTIMUM ALTITUDE
		NM	149	160	172	182	192	203	213	225	CLIMB TO OPTIMUM ALTITUDE AND DESCEND ON COURSE
		MIN	43	45	47	49	50	52	54	55	
	3,000 LB	NM	133	159	182	205	231	253	279	294	CRUISE AT INITIAL ALTITUDE AND DESCEND ON COURSE
		MIN	46	52	57	60	64	65	70	70	
		FT x 1,000	35	35	35	35	35	35	35	35	OPTIMUM ALTITUDE
		NM	217	229	240	251	261	273	284	294	CLIMB TO OPTIMUM ALTITUDE AND DESCEND ON COURSE
		MIN	57	60	61	63	65	67	68	70	
CRUISE ALT FT x 1,000		SL	5	10	15	20	25	30	35	CRUISE AT MAX RANGE AOA ~15.6 UNITS	
CRUISE SPEED - KIAS		180	177	175	173	170	168	166	163		
CRUISE FF ~100 LB/HR		24.1	22.0	21.1	20.5	19.6	19.5	19.2	19.7		
DESCENT DIST - NM		0	8	17	26	35	44	54	65	DESCEND AT 146 KIAS SPEED BRAKES CLOSED, IDLE THRUST	
DESCENT FUEL - LB		0	29	56	83	108	133	156	178		

- FUEL, TIME, AND DISTANCE INCLUDED FOR CLIMB TO OPTIMUM ALTITUDE, CRUISE, AND ON-COURSE MAXIMUM RANGE DESCENT TO SEA LEVEL DESTINATION.

Figure A4-8 (Sheet 2 of 3)

DIVERSION RANGE SUMMARY
DRAG INDEX = 4
• STANDARD DAY
• NO WIND CONDITIONS

RANGE AND TIME WITH 1,200 LB FUEL REMAINING FOR APPROACH AND LANDING											
INITIAL ALTITUDE x 1,000		SL	5	10	15	20	25	30	35	OPTION	
FUEL REMAINING	1,500 LB	NM	21	30	38	46	55	63	71	78	CRUISE AT INITIAL ALTITUDE AND DESCEND ON COURSE
		MIN	7	10	13	15	18	19	22	23	
		FT x 1,000	10	10	15	20	20	25	30	30	OPTIMUM ALTITUDE
		NM	25	32	40	47	55	63	71	78	CLIMB TO OPTIMUM ALTITUDE AND DESCEND ON COURSE
		MIN	9	11	14	16	18	19	22	23	
	2,000 LB	NM	56	69	82	95	109	121	133	142	CRUISE AT INITIAL ALTITUDE AND DESCEND ON COURSE
		MIN	19	23	26	29	32	33	36	37	
		FT x 1,000	20	25	25	30	30	30	30	35	OPTIMUM ALTITUDE
		NM	75	85	95	104	114	124	133	142	CLIMB TO OPTIMUM ALTITUDE AND DESCEND ON COURSE
		MIN	24	26	28	31	32	34	36	37	
	2,500 LB	NM	90	109	126	143	163	178	195	204	CRUISE AT INITIAL ALTITUDE AND DESCEND ON COURSE
		MIN	31	35	39	42	46	46	50	50	
		FT x 1,000	30	30	30	30	30	30	30	35	OPTIMUM ALTITUDE
		NM	133	144	155	165	175	185	195	204	CLIMB TO OPTIMUM ALTITUDE AND DESCEND ON COURSE
		MIN	38	41	43	44	47	48	50	50	
	3,000 LB	NM	125	148	170	191	216	235	256	266	CRUISE AT INITIAL ALTITUDE AND DESCEND ON COURSE
		MIN	43	48	52	55	61	59	64	64	
		FT x 1,000	30	30	30	30	30	30	30	35	OPTIMUM ALTITUDE
		NM	194	205	216	225	236	246	256	266	CLIMB TO OPTIMUM ALTITUDE AND DESCEND ON COURSE
		MIN	52	54	56	58	61	62	64	64	
CRUISE ALT FT x 1,000		SL	5	10	15	20	25	30	35	CRUISE AT MAX RANGE AOA ~15.6 UNITS	
CRUISE SPEED - KIAS		178	176	174	172	169	167	165	162		
CRUISE FF ~100 LB/HR		24.6	22.8	21.8	21.1	20.2	20.1	20.0	20.8		
DESCENT DIST - NM		-	8	16	24	33	42	51	61	DESCEND AT 148 KIAS SPEED BRAKES CLOSED, IDLE THRUST	
DESCENT FUEL - LB		-	27	53	77	101	123	144	165		

- FUEL, TIME, AND DISTANCE INCLUDED FOR CLIMB TO OPTIMUM ALTITUDE, CRUISE, AND ON-COURSE MAXIMUM RANGE DESCENT TO SEA LEVEL DESTINATION.

Figure A4-8 (Sheet 3 of 3)

PART V
 ENDURANCE

TABLE OF CONTENTS

	<u>Page</u>
Endurance Charts	A5-1

LIST OF CHARTS

<u>Figure</u>		<u>Page</u>
A5-1	Equivalent Gross Weight with Bank Angle	A5-5
A5-2	Maximum Endurance	A5-6
A5-3	Maximum Endurance (Single-Engine).	A5-8

ENDURANCE CHARTS

The endurance charts presented in this section provide a means of determining the optimum airspeed and fuel required to loiter at a given altitude for a specific period of time. If the loiter period requires turning flight, the aircraft gross weight should be corrected for bank angle. This corrected gross weight is defined as equivalent gross weight with bank angle, and is presented on figure A5-1 as a function of bank angle. The maximum endurance charts for two-engine and single-engine operation are presented on figures A5-2 and A5-3, respectively. Single-engine charts include failed engine windmilling. Sheet 1 of each chart presents optimum loiter altitude and total fuel flow. A temperature correction grid (variation from standard day) to total fuel flow is included for optional use. Sheet 2 of each chart presents maximum endurance airspeed and fuel required to loiter (or loiter time available if fuel is known).

DIRECTIONS FOR USE OF CHARTS

Enter figure A5-1 with gross weight and contour the nearest guideline to the right while simultaneously entering the bank.

angle scale with the desired bank angle and projecting up. At the point of intersection of the two projections, proceed to the right and read the equivalent gross weight. Now, enter sheet 1 of figure A5-2 (two-engine) or A5-3 (single-engine) with pressure altitude and proceed across to the right to equivalent gross weight. (If maximum loiter time is desired, use the upper right grid to find optimum maximum endurance altitude. Enter with equivalent gross weight, proceed right to drag index, and then down to altitude scale.) From the point of intersection with equivalent gross weight, drop down to the appropriate drag index, and then proceed to the right to the baseline of the temperature correction grid (standard day). For nonstandard day temperatures, contour the guidelines to the temperature variation (if standard day conditions exist, proceed directly through the correction grid), and then proceed to the right and read the total fuel flow, in pounds per hour.

Sheet 2 of the two-engine or single-engine endurance charts provides optimum endurance airspeed and fuel required (or loiter time available). Enter the top portion of the appropriate chart with equivalent gross weight, proceed to the right to the drag index, and then project down to the

indicated airspeed. Enter the bottom portion of the chart with total fuel flow, proceed across to the right to the desired loiter time, and then drop vertically to read the fuel required for loiter.

If loiter fuel is already known, project up from the fuel required scale and simultaneously intersect the horizontally projected line from the fuel flow to obtain the loiter time available.

For loiter time of long duration (more than 20 minutes), greater accuracy requires use of average gross weight during loiter to calculate the fuel required. To obtain average loiter weight, the fuel required to loiter must first be determined based on gross weight at start or end of loiter and then is recalculated based on start or end gross weight, decreased or increased, respectively, by half the calculated loiter fuel.

Sample Problem

Given:

- A. End cruise gross weight = 28,191 lb
- B. Desired two-engine loiter time with bank angle of 20° = 20 min
- C. Loiter pressure altitude = 15,000 ft
- D. Drag index = 2
- E. Temperature variation from standard day = +10°C

Calculate:

- A. Fuel flow, indicated airspeed, and fuel required for 20-minute loiter
- B. Use equivalent gross weight with bank angle chart, figure A5-1
 - 1. Gross weight 28,191 lb
 - 2. Bank angle 20°
 - 3. Intersection

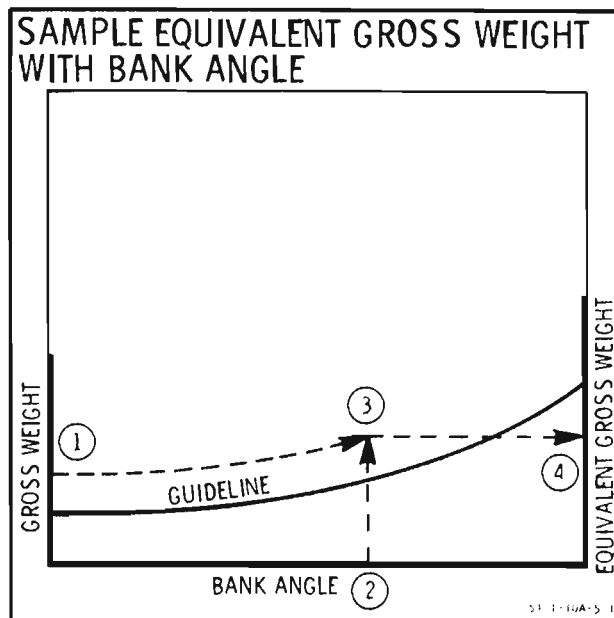

4. Equivalent gross weight 30,000 lb

C. Use maximum endurance - fuel flow and optimum altitude chart, figure A5-2, sheet 1

- 1. Loiter pressure altitude 15,000 ft
- 2. Equivalent gross weight 30,000 lb
- 3. Drag index 2
- 4. Go to temperature baseline (standard day temperature)
- 5. Temperature variation from standard day +10°C
- 6. Total fuel flow 1,860 lb/hr

If optimum maximum endurance altitude was desired, use upper right grid of sheet 1.

- 7. Equivalent gross weight 30,000 lb
- 8. Drag index 2
- 9. Optimum endurance altitude 24,500 ft

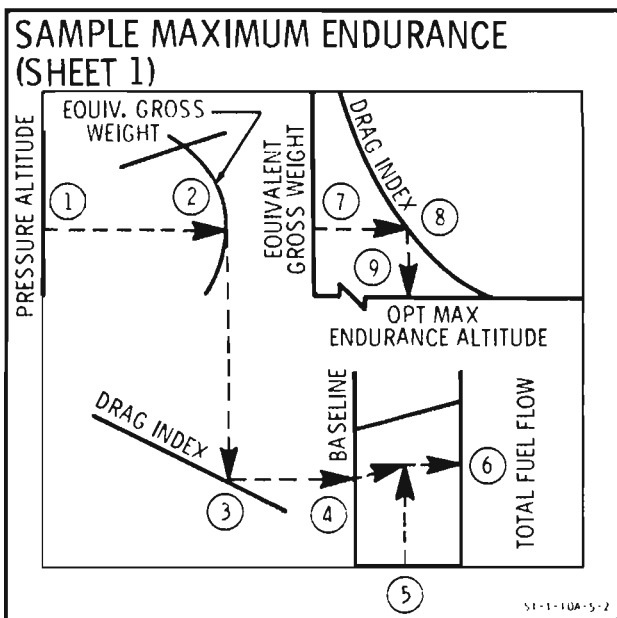

Substituting optimum endurance altitude for the pressure altitude, the resulting fuel flow is 1,800 lb/hr.

D. Use maximum endurance - indicated airspeed and fuel required chart, figure A5-2, sheet 2

1. Equivalent gross weight 30,000 lb

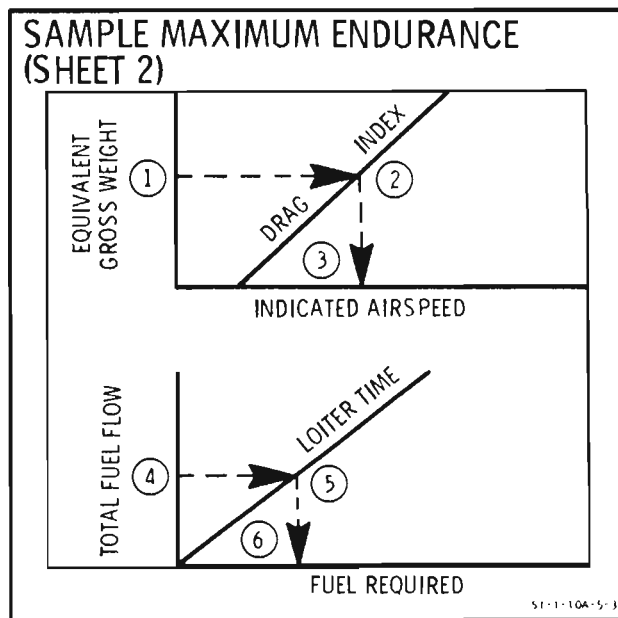

- | | |
|-----------------------|--------------------|
| 2. Drag index | 2 |
| 3. Indicated airspeed | 146 KIAS |
| 4. Total fuel flow | 1,860 lb/hr |
| 5. Loiter time | 20 min
(1/3 hr) |
| 6. Fuel required | 620 lb |

This page intentionally left blank.

MODEL : A-10A
DATE : 30 NOVEMBER 1982
DATA BASIS : **A . F . FLIGHT TEST**
ENGINES : (2) TF34-GE-100/-100A

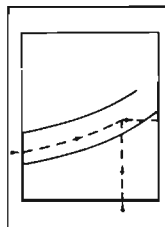

**EQUIVALENT
GROSS WEIGHT
WITH
BANK ANGLE**

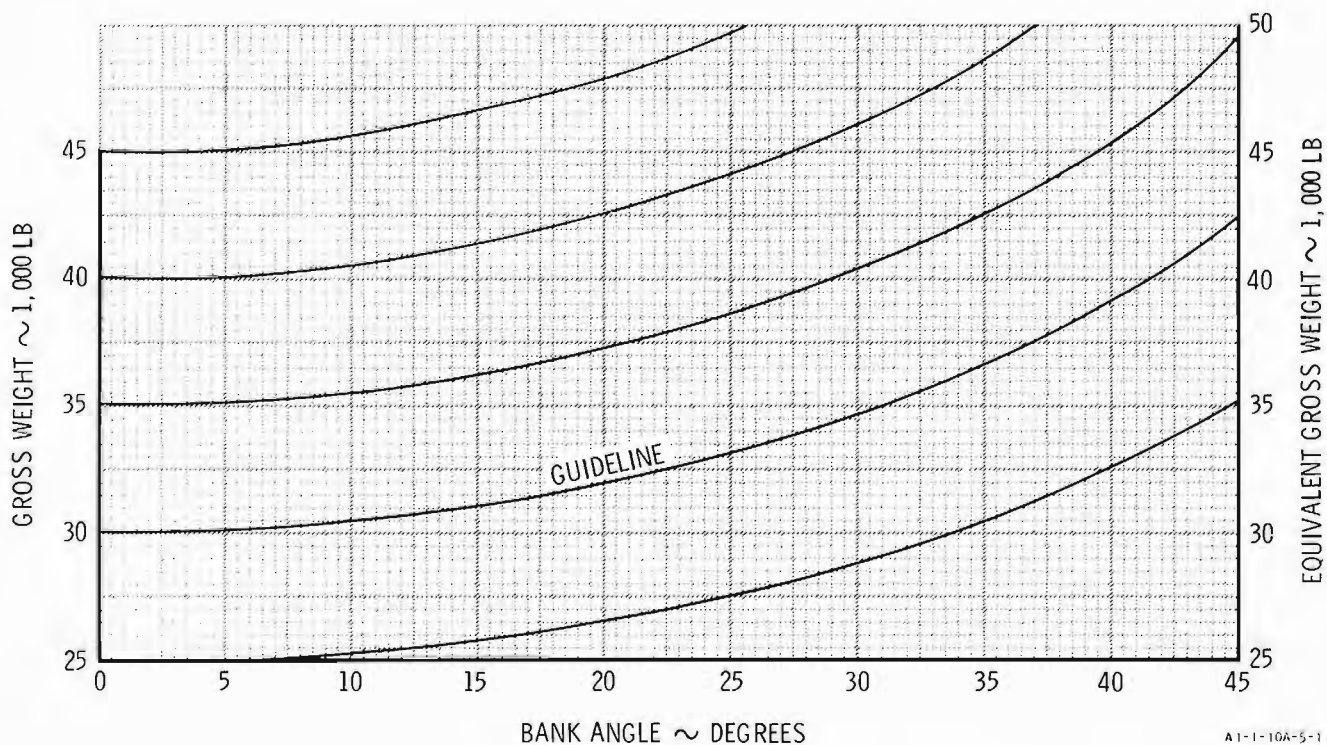

A 1-1-10A-5-1

Figure A5-1

**MAXIMUM ENDURANCE
Fuel Flow and Opt. Altitude**

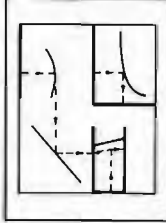

MODEL : A-10A
 DATE : 30 NOVEMBER 1982
 DATA BASIS : A . F . FLIGHT TEST
 ENGINES : (2) TF34-GE-100/-100A

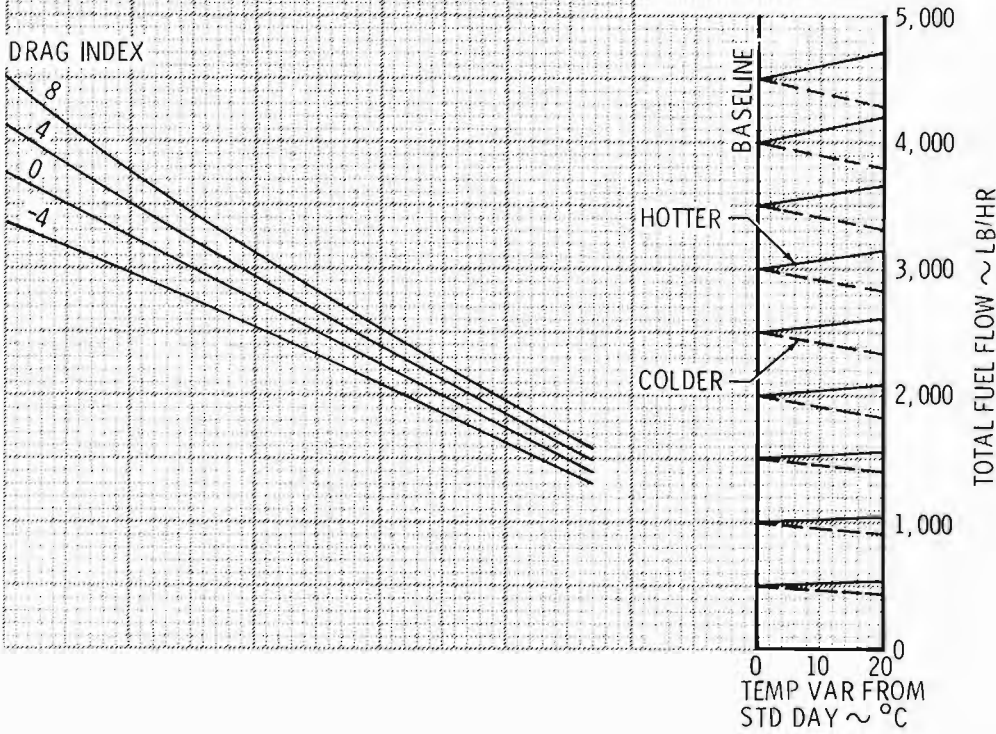
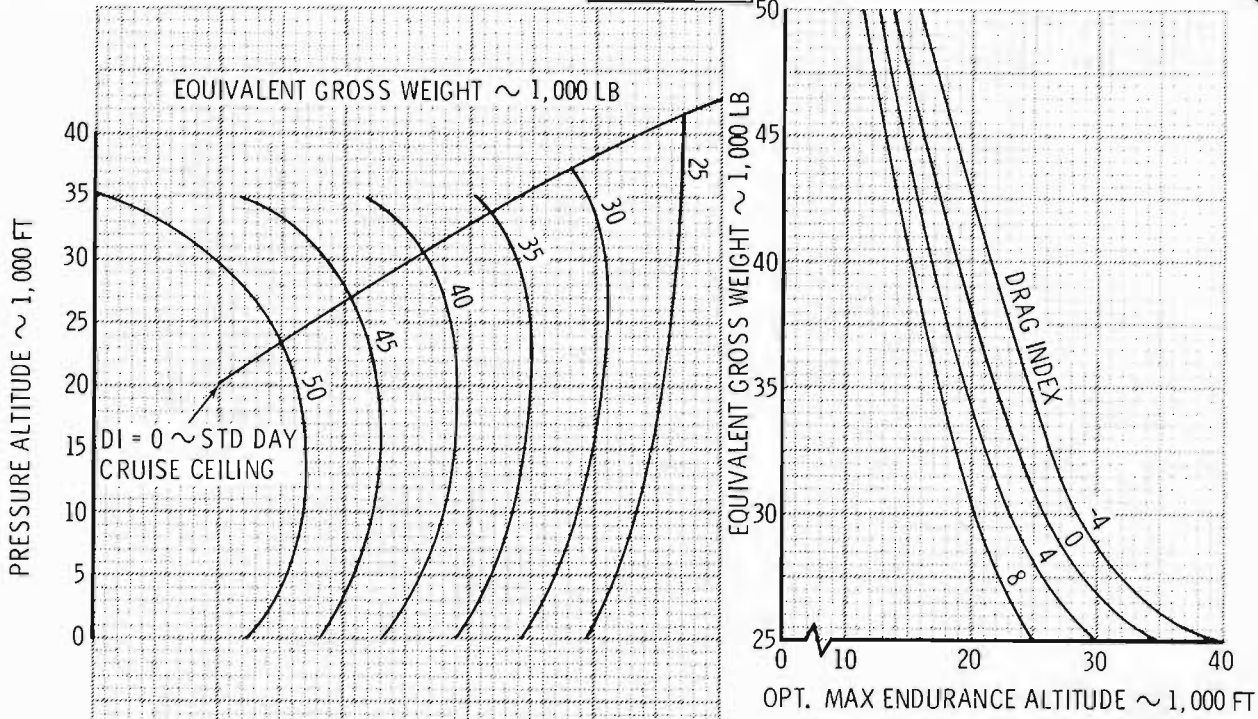
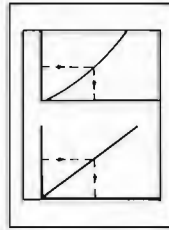

Figure A5-2 (Sheet 1 of 2)

MODEL : A-10A
DATE : 30 NOVEMBER 1982
DATA BASIS : A.F. FLIGHT TEST
ENGINES : (2) TF34-GE-100/-100A



MAXIMUM ENDURANCE
Speed, Fuel Required

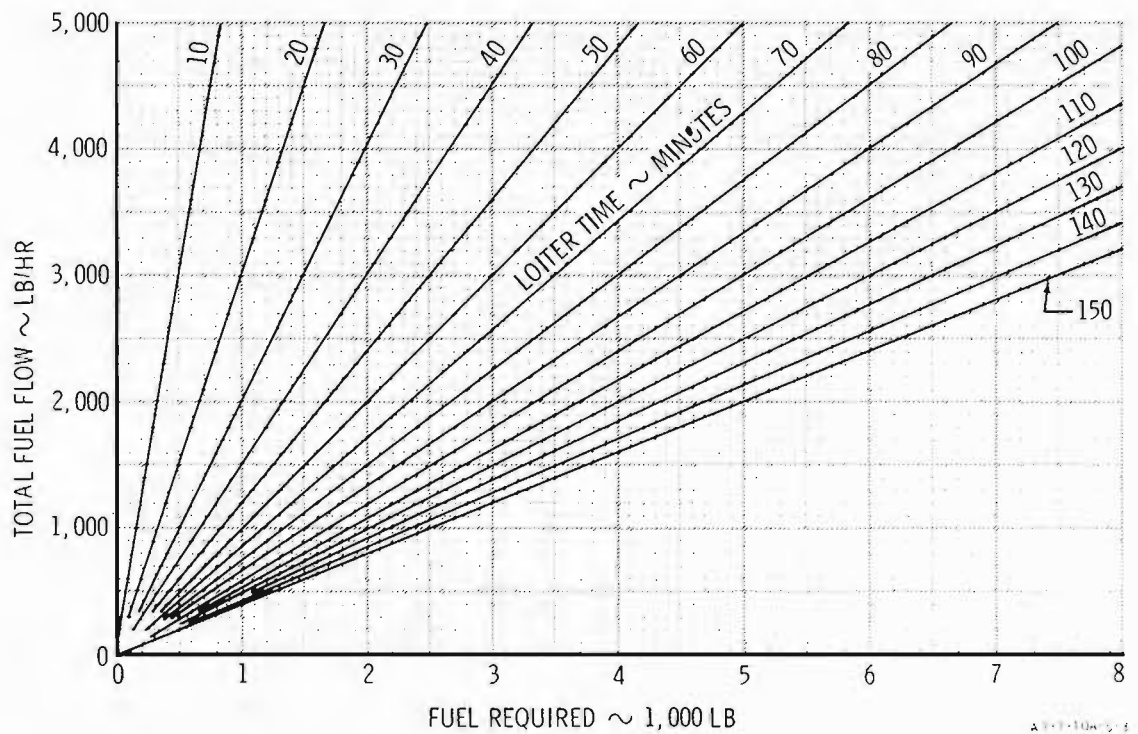
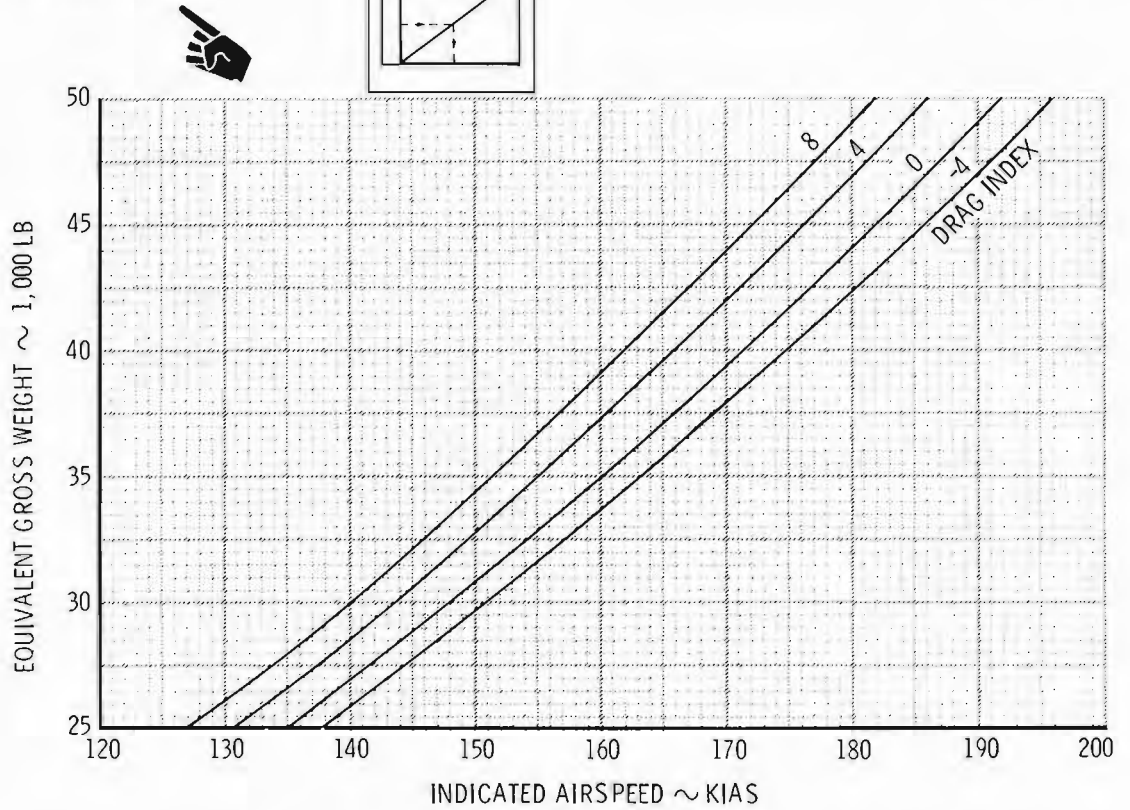
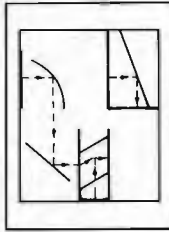

Figure A5-2 (Sheet 2 of 2)

MAXIMUM ENDURANCE
Fuel Flow and Opt. Altitude
SINGLE-ENGINE
Failed Engine Windmilling



MODEL : A-10A
 DATE : 30 NOVEMBER 1982
 DATA BASIS : **A.F. FLIGHT TEST**
 ENGINES : (2) TF34-GE-100/-100A

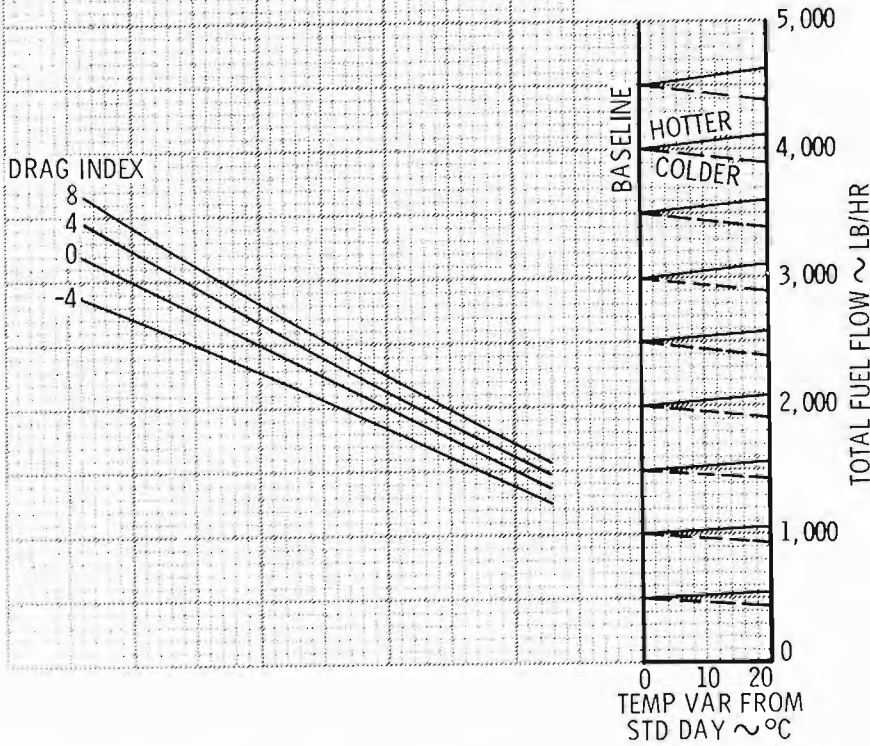
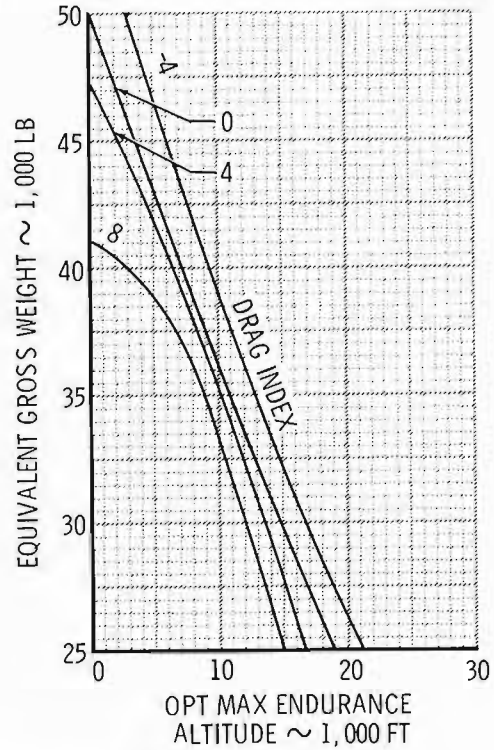
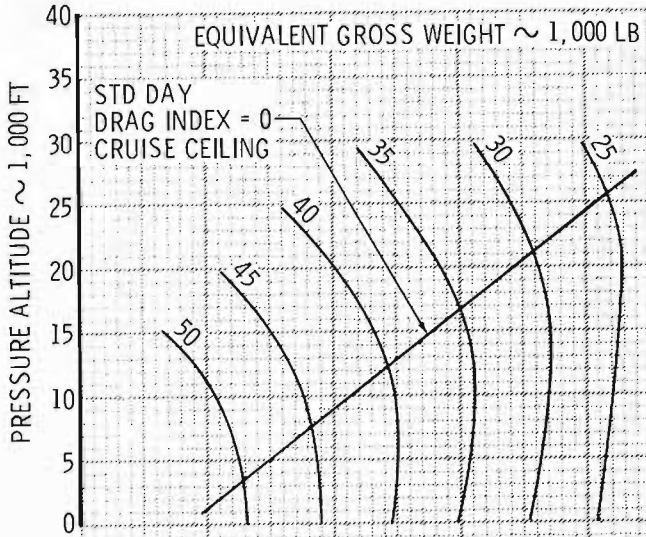
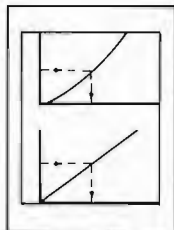

Figure A5-3 (Sheet 1 of 2)

A1-1-10A-5-4

MODEL : A-10A
 DATE : 30 NOVEMBER 1982
 DATA BASIS : A . F . FLIGHT TEST
 ENGINES : (2) TF34-GE-100/-100A



MAXIMUM ENDURANCE
Speed and Fuel Required
SINGLE-ENGINE
Failed Engine Windmilling

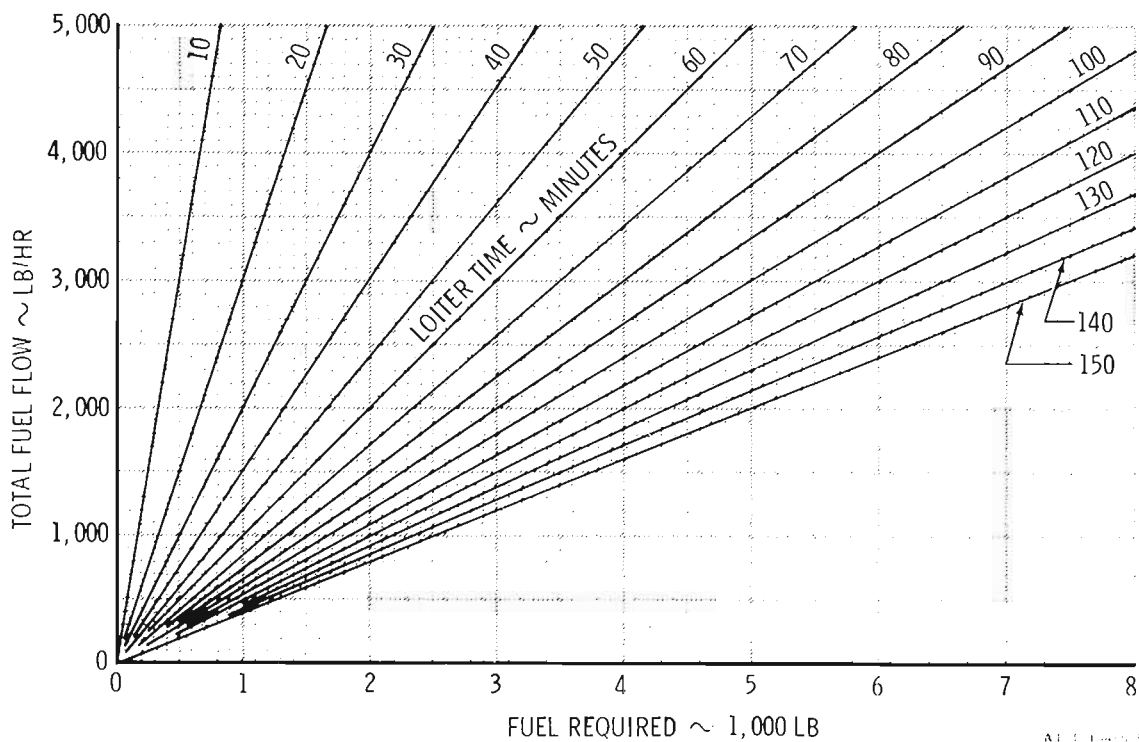
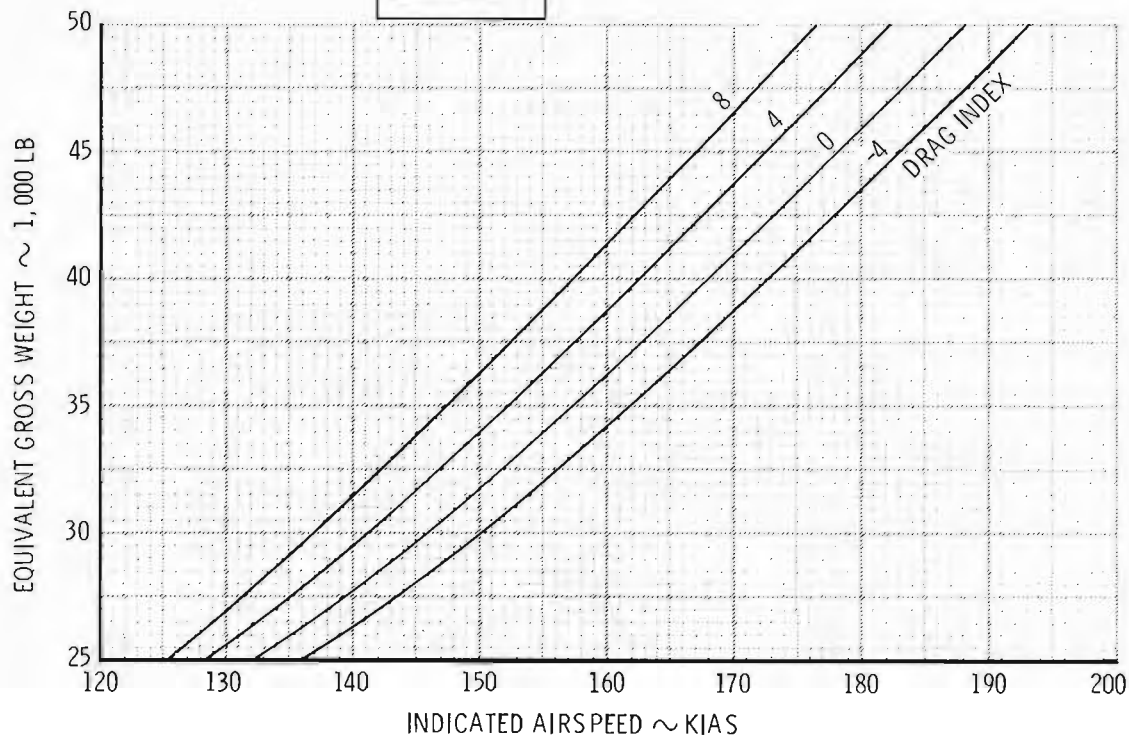

Figure A5-3 (Sheet 2 of 2)

PART VI

COMBAT

TABLE OF CONTENTS

	<u>Page</u>
Combat Performance Charts (General).....	A6-1
Level Flight Maximum Speed Chart	A6-1
Combat Fuel Flow Charts	A6-2
Combat Allowance - Fuel and Time Chart	A6-3
Sustained Turn Performance Charts	A6-4
Instantaneous Turn Performance Chart	A6-4
Turn Radius/Rate Chart	A6-5
Altitude Lost in Dive Recovery Chart	A6-6

LIST OF CHARTS

<u>Figure</u>		<u>Page</u>
A6-1	Level Flight Maximum Speed	A6-8
A6-2	Combat Fuel Flow Standard Day	A6-9
A6-3	Combat Fuel Flow Standard Day -20°C Maximum Thrust	A6-10
A6-4	Combat Fuel Flow Standard Day -20°C 3% Below PTFS	A6-11
A6-5	Combat Fuel Flow Standard Day +20°C Max and 3% Below PTFS	A6-12
A6-6	Combat Allowance	A6-13
A6-7	Sustained Turn Performance	A6-14
A6-8	Instantaneous Turn Performance	A6-16
A6-9	Turn Radius and Turn Rate	A6-17
A6-10	Altitude Lost in Dive Recovery	A6-18

COMBAT PERFORMANCE CHARTS (GENERAL)

The combat performance charts present maximum level flight speeds, total fuel flow of the aircraft, combat allowance, sustained and instantaneous maneuver load factor, turn rate, turn radius, and altitude lost in dive recovery. The maximum level flight speed and total fuel flow charts present data for standard day and standard $\pm 20^{\circ}\text{C}$ day conditions. The fuel flows are shown for both maximum and 775°C ITT thrust settings.

LEVEL FLIGHT MAXIMUM SPEED CHART

The level flight maximum speed chart, figure A6-1, presents the 1g maximum speed of the aircraft at maximum thrust as a function of gross weight, pressure altitude, drag index, and temperature. The temperature correction scale enables the user to correct for colder- or hotter-than-standard day conditions.

DIRECTIONS FOR USE OF CHART

Enter the chart with aircraft gross weight, proceed to the right to pressure altitude,

drop down to the desired drag index, and then proceed to the left to the baseline of the temperature scale. If the temperature is standard, proceed through; if not, contour the nearest guideline for hotter or colder temperature variation, and then proceed across to read the indicated airspeed.

Sample Problem

Given:

- A. Aircraft gross weight = 35,000 lb
- B. Pressure altitude = 5,000 ft
- C. Drag index = 0
- D. Temperature variation from standard day = +10°C

Calculate:

- A. Level flight maximum speed with maximum thrust
- B. Use level flight maximum speed maximum thrust chart, figure A6-1

- 1. Gross weight 35,000 lb

- 2. Pressure altitude 5,000 ft
- 3. Drag Index 0
- 4. Go to temperature baseline (standard day temperature)
- 5. Temperature variation +10°C
- 6. Indicated airspeed 318 KIAS

COMBAT FUEL FLOW CHARTS

The combat fuel flow charts are presented on figures A6-2 through A6-5 for two-engine operation at maximum and 3% below PTFS settings. These data are shown as a function of indicated airspeed and pressure altitude. Figures A6-2 and A6-5 present total fuel flow data for standard and standard +20°C days, respectively. Standard -20°C day fuel flow data at maximum and 3% below PTFS are shown on figures A6-3 and A6-4, respectively. The fuel flow determined from these charts represents the fuel consumption rate when operating the engines at a specified thrust setting at a single airspeed and altitude flight condition; for example, at 260 KIAS, sea level, under standard day conditions, the engines will consume 7,100 pounds of fuel per hour for maximum thrust (see figure A6-2). Therefore, the charts could be used to determine fuel flow at maximum speed for a given aircraft configuration, pressure altitude, and temperature.

Note

For temperature variations between +20°C and -20°C, interpolate linearly.

DIRECTIONS FOR USE OF CHARTS

Enter the appropriate chart with indicated airspeed, move vertically up to the desired pressure altitude, and then proceed horizontally to proper total fuel flow scale.

Sample Problem

Given:

- A. Maximum thrust

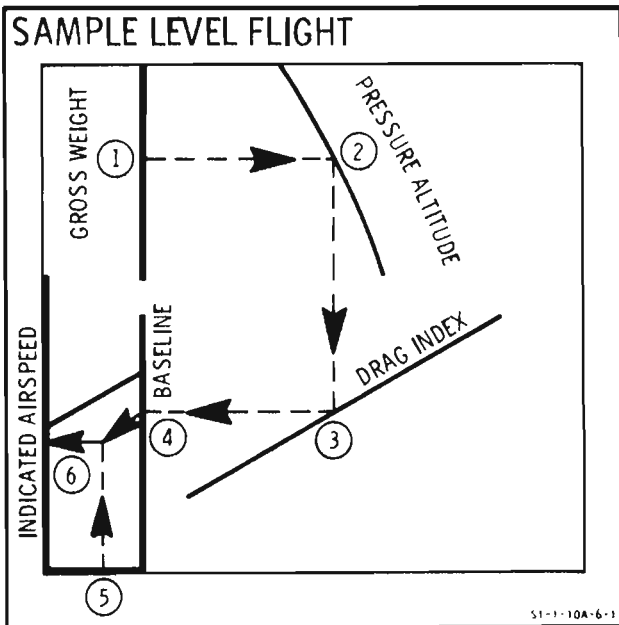

- B. Standard day temperature
- C. Indicated airspeed = 260 KIAS
- D. Pressure altitude = 5,000 ft

Calculate:

A. Total fuel flow for maximum thrust at standard day temperature

B. Use combat fuel flow, standard day chart, figure A6-2, upper portion

- 1. Indicated airspeed 260 KIAS
- 2. Pressure altitude 5,000 ft
- 3. Total fuel flow 6,300 lb/hr

COMBAT ALLOWANCE—FUEL AND TIME CHART

The combat allowance - fuel and time chart is presented on figure A6-6. This chart is included in this section to provide the fuel required for a specified time or the time available for a given quantity of fuel as a function of total fuel flow.

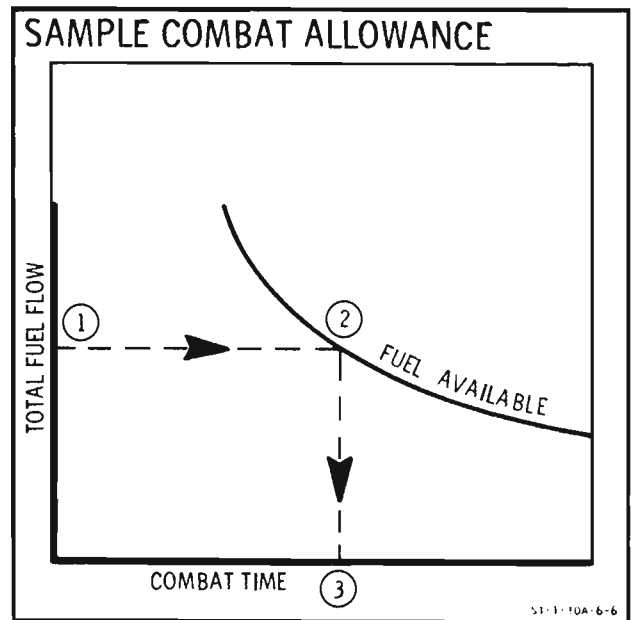

DIRECTIONS FOR USE OF CHART

Enter the chart with total fuel flow, proceed to the right to the desired quantity of fuel, and then drop down to the combat time scale to read the time available.

DIRECTIONS FOR ALTERNATE USE OF CHART

Enter the chart with total fuel flow and proceed to the right. Enter the chart with combat time and proceed vertically up. At the point of intersection of these two lines, the fuel required can be interpolated.

Sample Problem

Given:

- A. Total fuel flow = 5,000 lb/hr
- B. Fuel available = 2,000 lb

Calculate:

- A. Combat time available
- B. Use combat allowance - fuel and time chart, figure A6-6

- 1. Total fuel flow 5,000 lb/hr

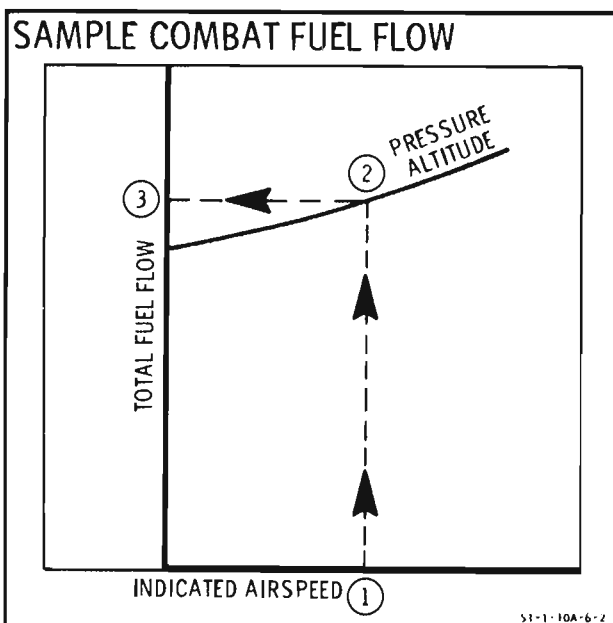

- 2. Fuel available 2,000 lb
- 3. Combat time available 24 min

SUSTAINED TURN PERFORMANCE CHARTS

The sustained turn performance charts are presented on figure A6-7, sheets 1 and 2, for maximum thrust at standard day temperatures. The sustained normal load factor data are shown as a function of indicated airspeed, pressure altitude, aircraft gross weight, and drag index. Sheet 1 presents data for drag index values of -4 and 0; sheet 2 presents data for drag index values of 4 and 8. These charts provide a means of determining the sustained load factor available at any airspeed up to V_{max} for a full range of pressure altitudes, gross weights, and drag indexes at maximum thrust. For drag index values other than -4, 0, 4, and 8, interpolate linearly between adjacent values.

DIRECTIONS FOR USE OF CHARTS

Enter the appropriate portion of the chart with indicated airspeed, proceed up to pressure altitude, move horizontally to the right to the aircraft gross weight, and then drop down to read the sustained load factor.

Sample Problem

Given:

- A. Drag index = 0
- B. Indicated airspeed = 275 KIAS
- C. Pressure altitude = sea level
- D. Gross weight = 35,000 lb
- E. Standard day, maximum thrust

Calculate:

- A. Sustained normal load factor for maximum thrust at standard day conditions
- B. Use sustained turn performance chart, figure A6-7, sheet 1, bottom portion of the chart

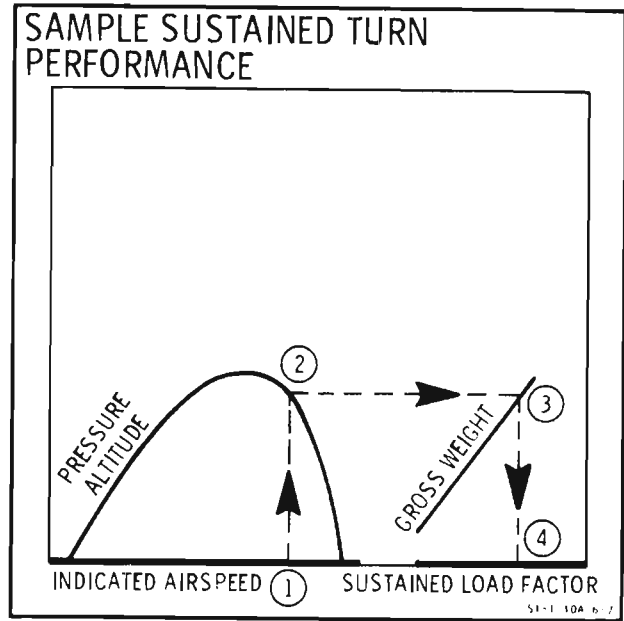

- 1. Indicated airspeed 275 KIAS
- 2. Pressure altitude sea level
- 3. Gross weight 35,000 lb
- 4. Sustained normal load factor 3.28

INSTANTANEOUS TURN PERFORMANCE CHART

The instantaneous turn performance chart is presented on figure A6-8 as a function of indicated airspeed, pressure altitude, and aircraft gross weight. The chart provides a means of determining the maximum instantaneous load factor available at any airspeed up to the structural limit airspeed (450 KCAS/0.75 Mach) for a full range of altitudes and gross weights. Note that instantaneous load factor is not a function of drag index.

DIRECTIONS FOR USE OF CHART

Enter the chart with indicated airspeed, proceed to the right to the desired pressure altitude, project up to the gross weight, and then proceed to the left to read the instantaneous load factor.

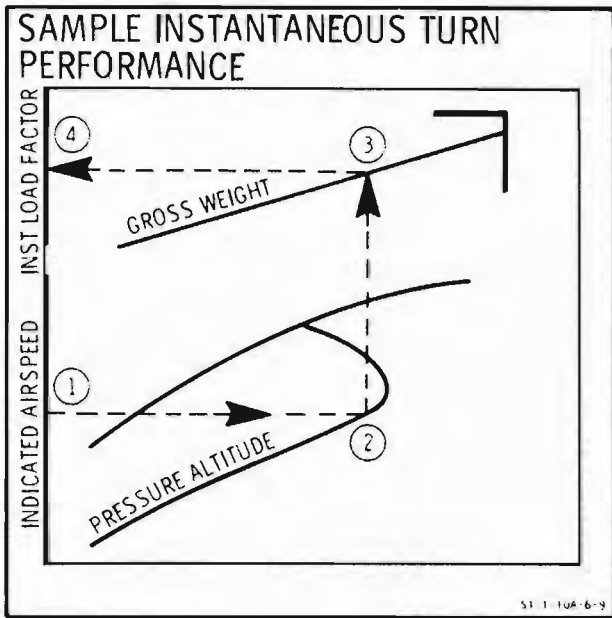

Sample Problem

Given:

- A. Indicated airspeed = 275 KIAS
- B. Pressure altitude = sea level
- C. Gross weight = 35,000 lb

Calculate:

- A. Instantaneous load factor available
- B. Use instantaneous turn performance chart, figure A6-8

- | | |
|-----------------------|-----------|
| 1. Indicated airspeed | 275 KIAS |
| 2. Pressure altitude | sea level |
| 3. Gross weight | 35,000 lb |
| 4. Load factor | 5.25 |

TURN RADIUS/RATE CHART

The turn radius/rate chart is presented on figure A6-9 as a function of load factor, indicated airspeed, and pressure altitude. The chart provides the ability to determine turn capability obtainable under sustained (level flight, constant speed) conditions and/or at the transient maximum lift

condition, depending upon the load factor used to enter the chart.

DIRECTIONS FOR USE OF CHART

To obtain turn radius, enter the upper portion of the chart with load factor (sustained or instantaneous), project up to the indicated airspeed, across to the right to the pressure altitude, and finally, drop down to the turn radius scale. To obtain turn rate, use the bottom portion of the chart and proceed in a similar manner as was used to determine turn radius.

Sample Problem

Given:

- A. Load factor (sustained from figure A6-7) = 3.28
- B. Indicated airspeed = 275 KIAS
- C. Pressure altitude = sea level

Calculate:

- A. Turn radius and turn rate
- B. Use turn radius/rate chart, figure A6-9, upper portion

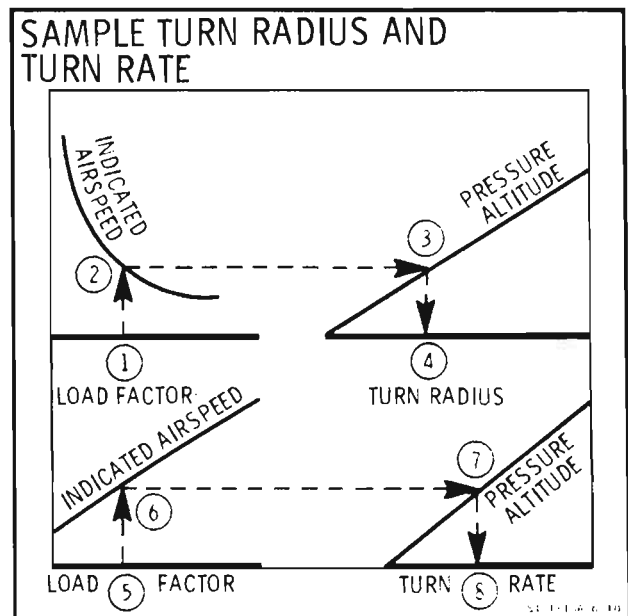

T.O. 1A-10A-1-1

- | | |
|-----------------------|-----------|
| 1. Load factor | 3.28 |
| 2. Indicated airspeed | 275 KIAS |
| 3. Pressure altitude | sea level |
| 4. Turn radius | 2,200 ft |
- C. Use turn radius/rate chart, figure A6-9, bottom portion
- | | |
|-----------------------|-----------|
| 5. Load factor | 3.28 |
| 6. Indicated airspeed | 275 KIAS |
| 7. Pressure altitude | sea level |
| 8. Turn rate | 12.5°/sec |

ALTITUDE LOST IN DIVE RECOVERY CHART

The altitude lost in a dive recovery chart is presented on figure A6-10. The altitude lost during pullout is shown as a function of pullout load factor, dive angle, pressure altitude (initial), and initial indicated airspeed. Dive recovery capability at constant load factor is insensitive to aircraft gross weight and drag index. The data presented in the chart are based on maximum thrust and a 2-second delay to allow for a buildup to the desired load factor.

Note

Consult figure A6-8 to obtain the maximum available load factor for a given airspeed, altitude, and gross weight condition.

DIRECTIONS FOR USE OF CHART

Enter the chart with initial indicated airspeed, project up to the initial pressure altitude, and across to the right to the dive angle. From this point of intersection, drop down to the pullout load factor, and project to the left to read altitude lost.

Sample Problem

Given:

- A. Initial indicated airspeed = 300 KIAS
- B. Initial pressure altitude = 15,000 ft
- C. Dive angle = 45°
- D. Pullout load factor = 5g

Calculate:

- A. Altitude lost in a 5g pullout from a 45° dive
- B. Use altitude lost in dive recovery chart, figure A6-10

- | | |
|------------------------|-----------|
| 1. Indicated airspeed | 300 KIAS |
| 2. Pressure altitude | 15,000 ft |
| 3. Dive angle | 45° |
| 4. Pullout load factor | 5g |
| 5. Altitude lost | 1,400 ft |

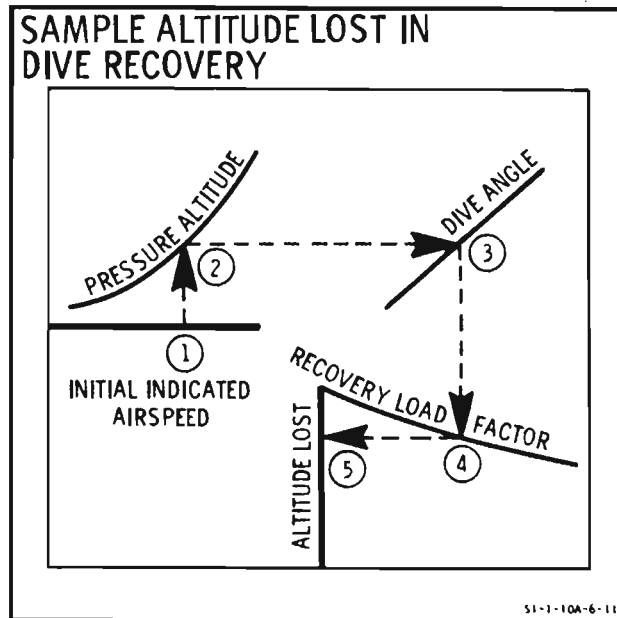

This page intentionally left blank

**LEVEL FLIGHT
MAXIMUM SPEED
Maximum Thrust**

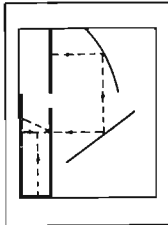

MODEL : A-10A
DATE : 30 NOVEMBER 1982
DATA BASIS : **A . F . FLIGHT TEST**
ENGINES : (2) TF34-GE-100/-100A

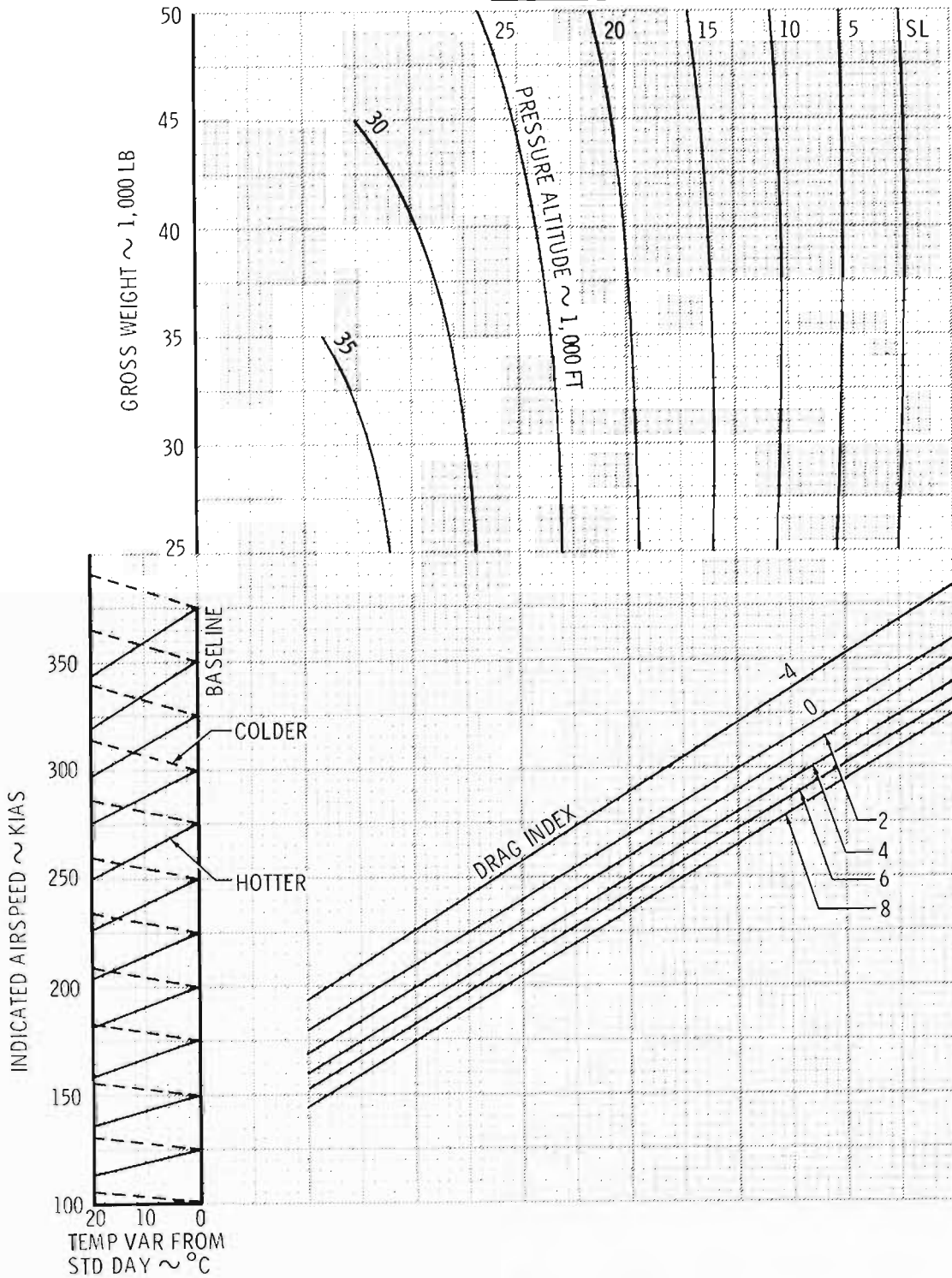

A1-1-10A-6-1

Figure A6-1

MODEL : A-10A
 DATE : 30 NOVEMBER 1982
 DATA BASIS : A.F. FLIGHT TEST
 ENGINES : (2) TF34-GE-100/-100A

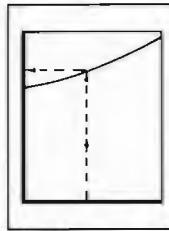

COMBAT FUEL FLOW
 Standard Day

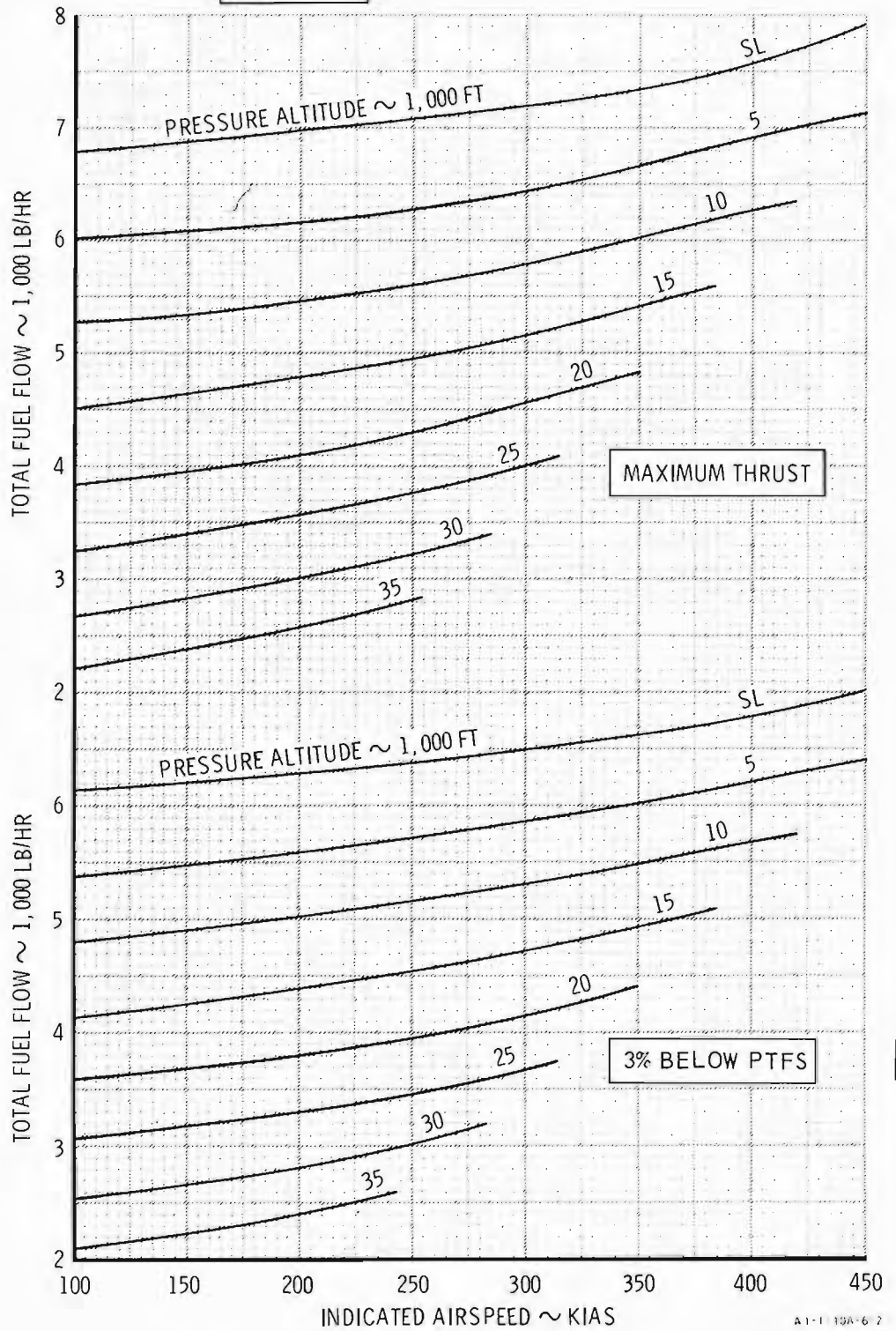
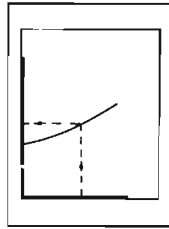
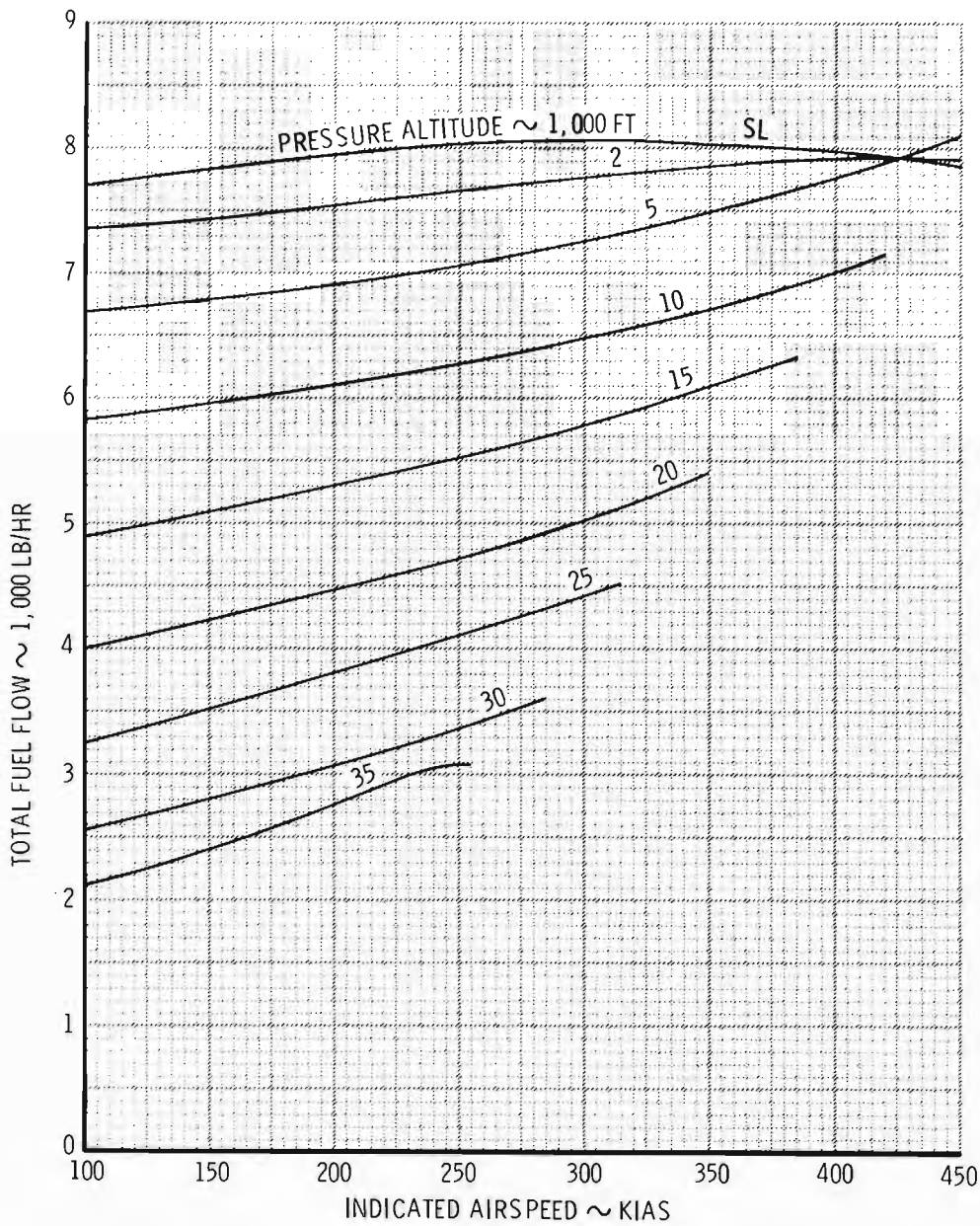

Figure A6-2

COMBAT FUEL FLOW
Standard Day - 20°C
Maximum Thrust



MODEL : A-10A
DATE : 30 NOVEMBER 1982
DATA BASIS : A . F . FLIGHT TEST
ENGINES : (2) TF34-GE-100/-100A



A 1-1-10A-6-3

Figure A6-3

MODEL : A-10A
DATE : 30 NOVEMBER 1982
DATA BASIS : **A . F . FLIGHT TEST**
ENGINES : (2) TF34-GE-100/-100A

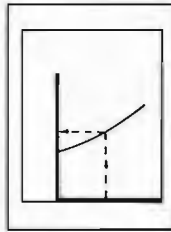

COMBAT FUEL FLOW
Standard Day - 20°C
3% Below Predicted Fan Speed

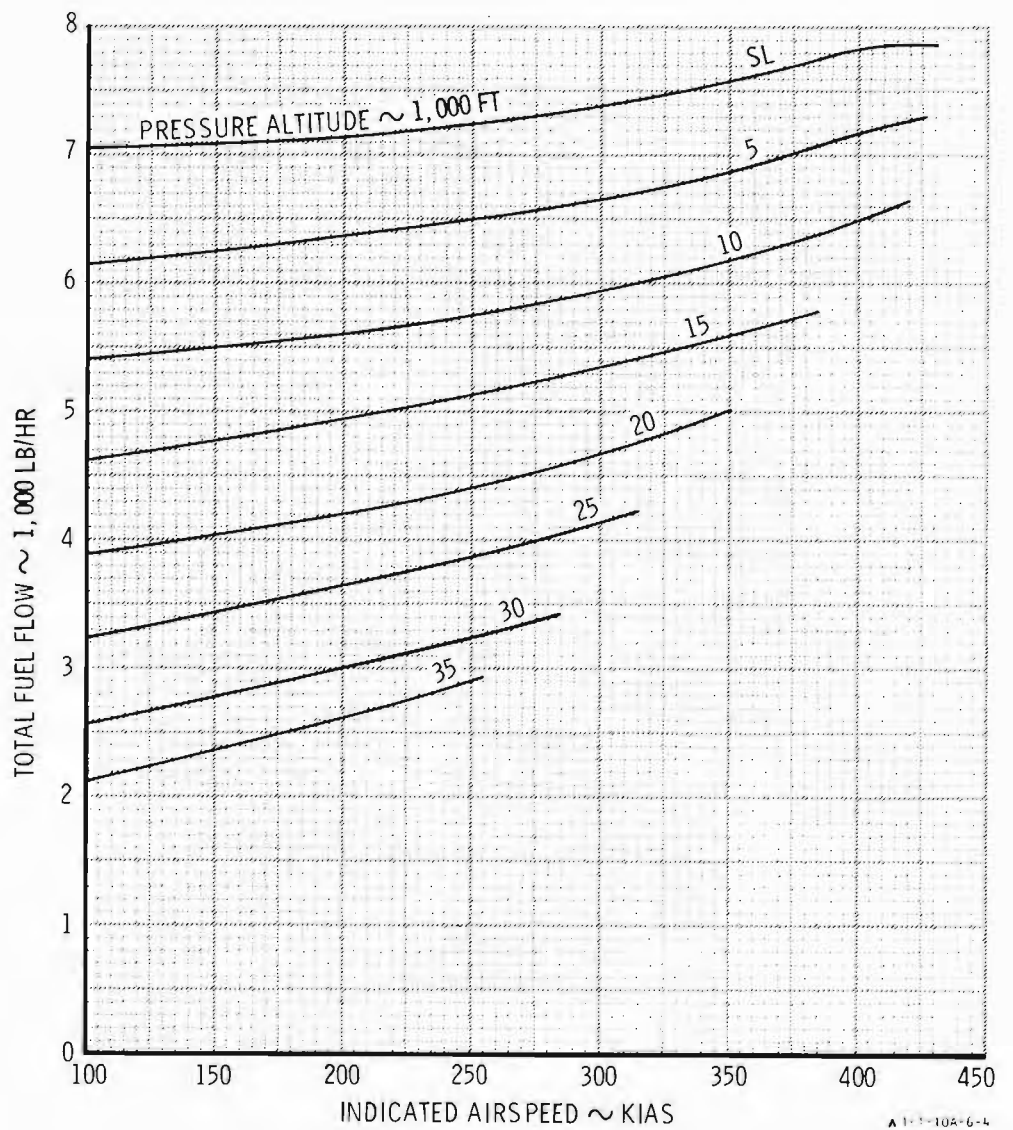
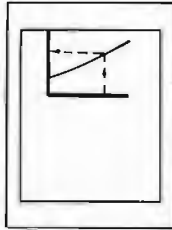
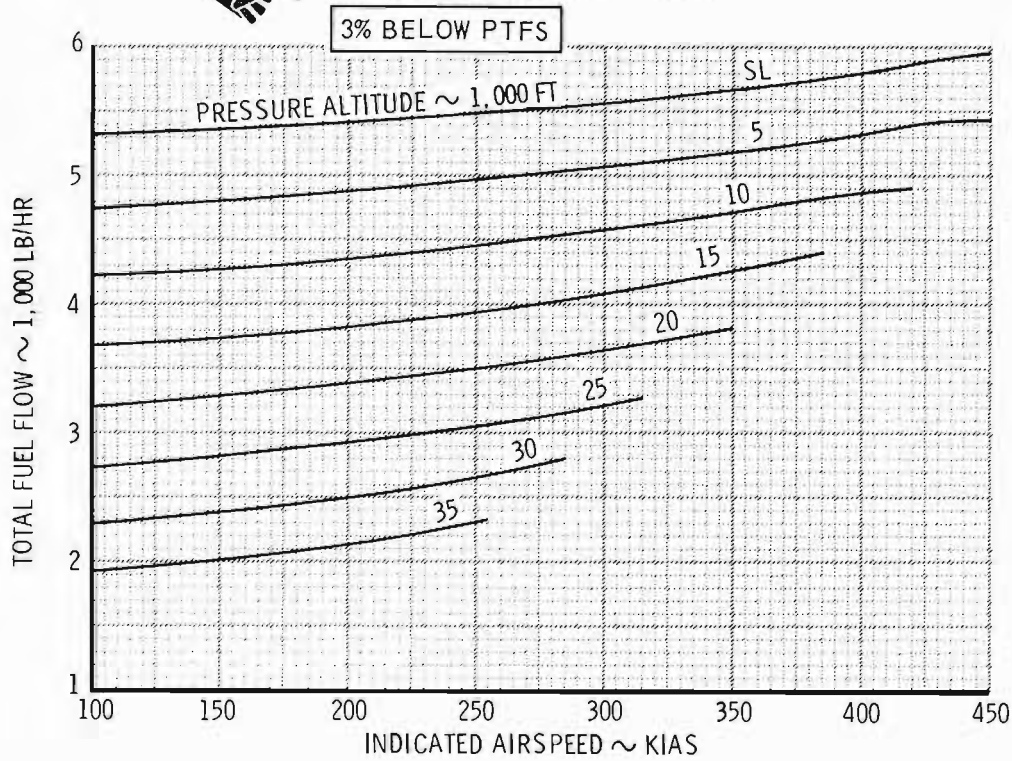
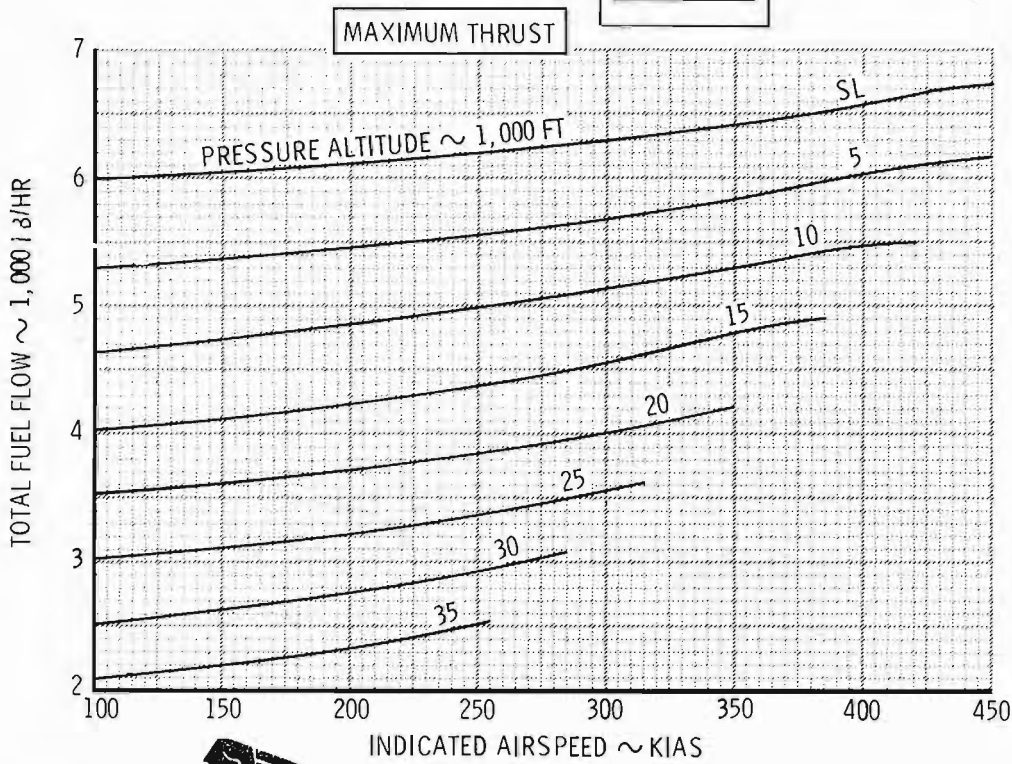

Figure A6-4

COMBAT FUEL FLOW
Standard Day+20°C



MODEL : A-10A
DATE : 30 NOVEMBER 1982
DATA BASIS : A . F . FLIGHT TEST
ENGINES : (2) TF34-GE-100/-100A



A1-1-10A-6-5

Figure A6-5

MODEL : A-10A
DATE : 30 NOVEMBER 1982
DATA BASIS : A . F. FLIGHT TEST
ENGINES : (2) TF34-GE-100/-100A

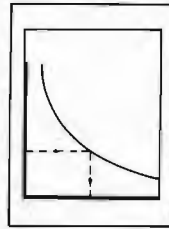

COMBAT ALLOWANCE
Fuel and Time

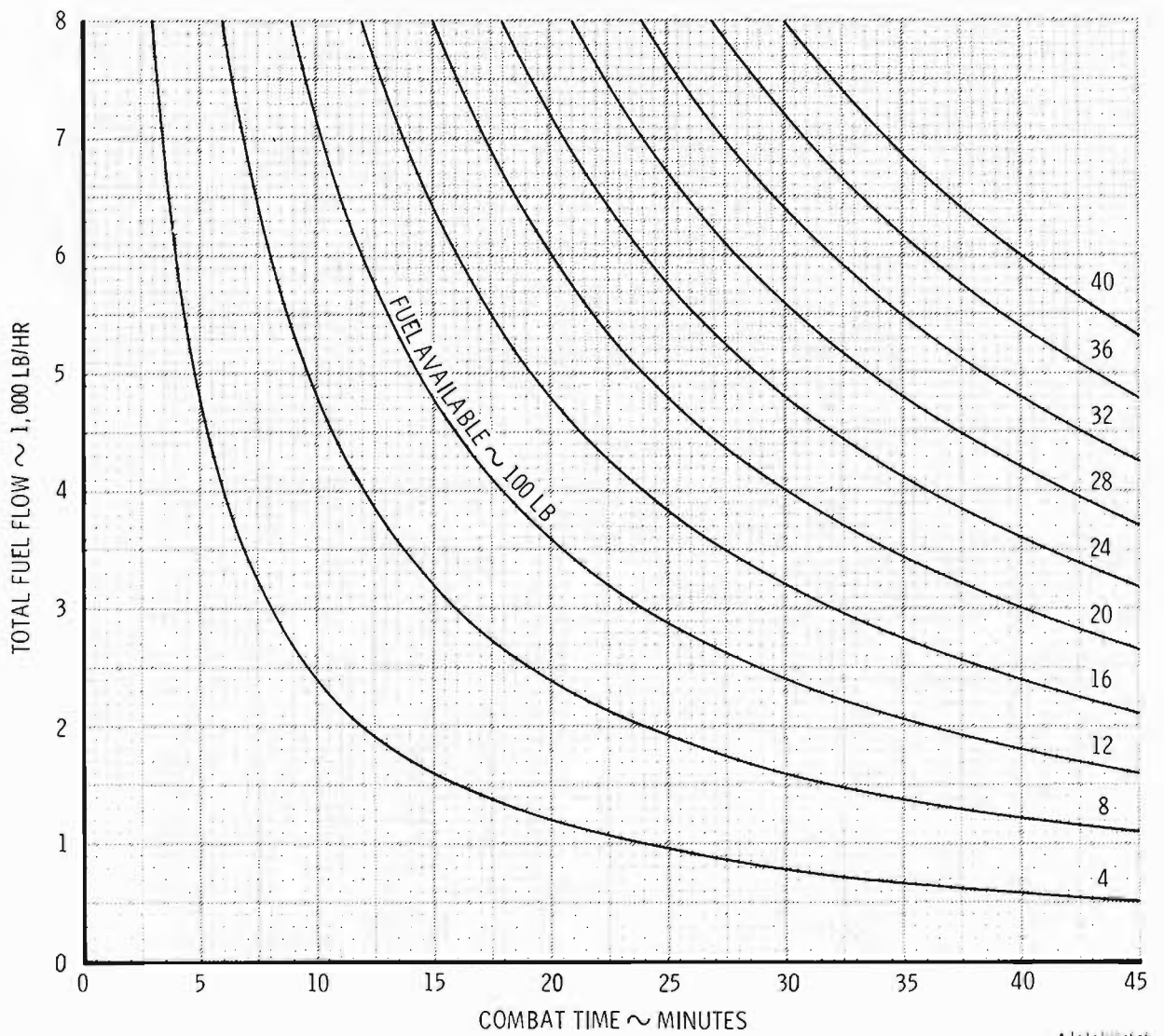

A 1-1-10A-6-6

Figure A6-6

SUSTAINED TURN PERFORMANCE
Standard Day
Maximum Thrust

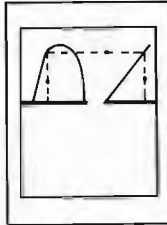

MODEL : A-10A
DATE : 30 NOVEMBER 1982
DATA BASIS : **A . F . FLIGHT TEST**
ENGINES : (2) TF34-GE-100/-100A

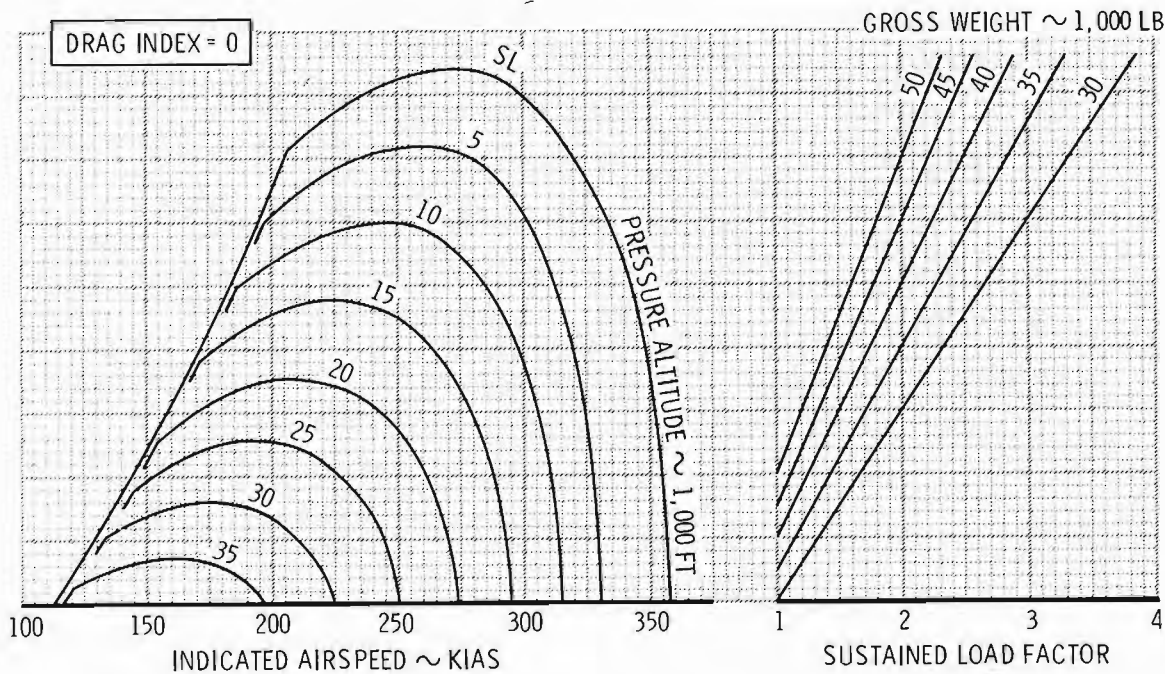
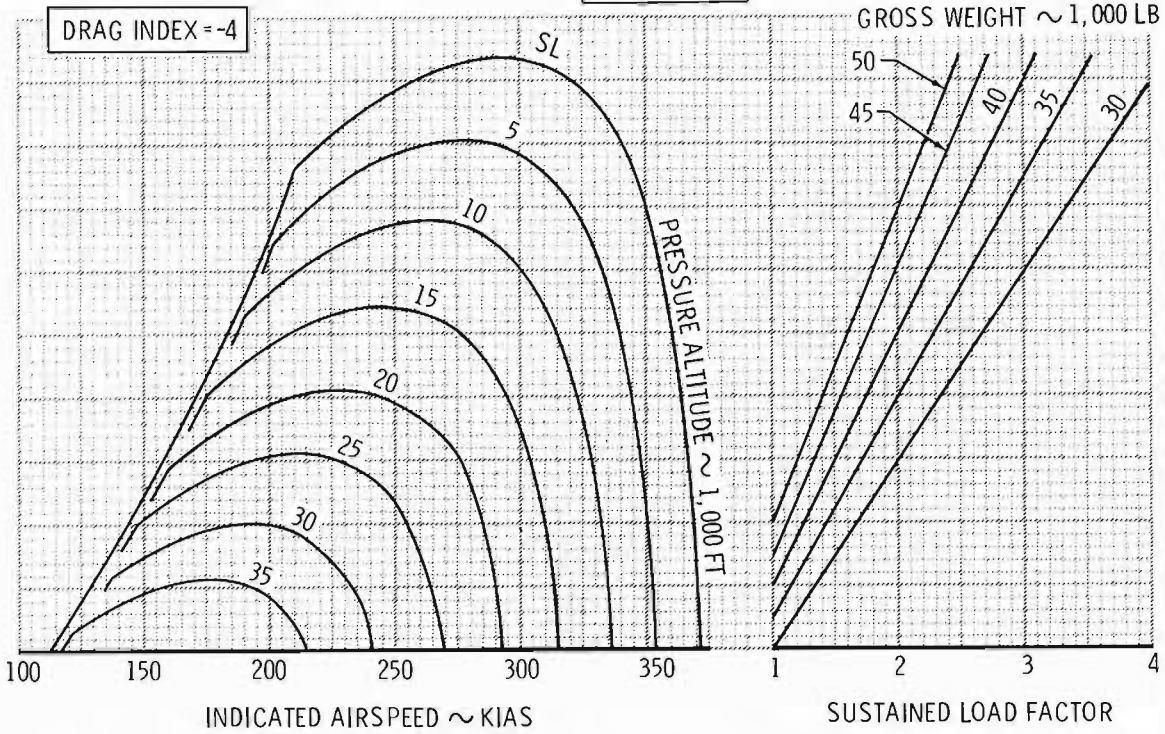

A1-1-10A-6-7

Figure A6-7 (Sheet 1 of 2)

MODEL : A-10A
DATE : 30 NOVEMBER 1982
DATA BASIS : A.F. FLIGHT TEST
ENGINES : (2) TF34-GE-100/-100A

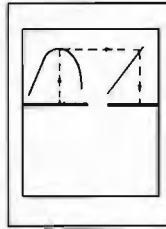

**SUSTAINED TURN
PERFORMANCE
Standard Day
Maximum Thrust**

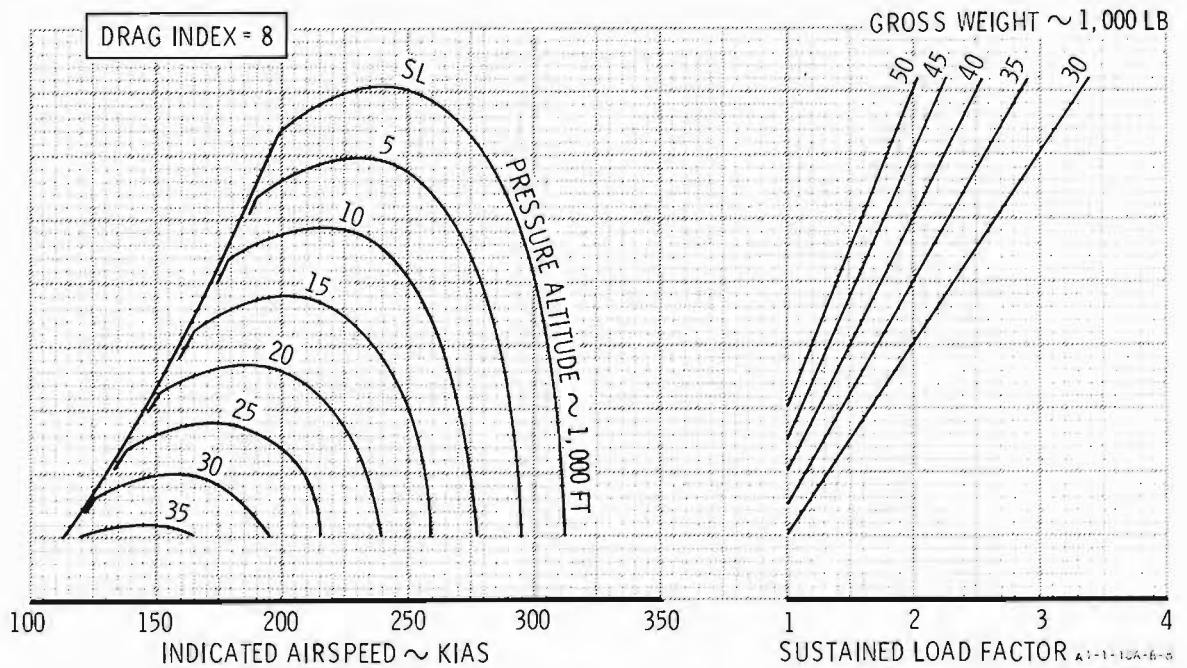
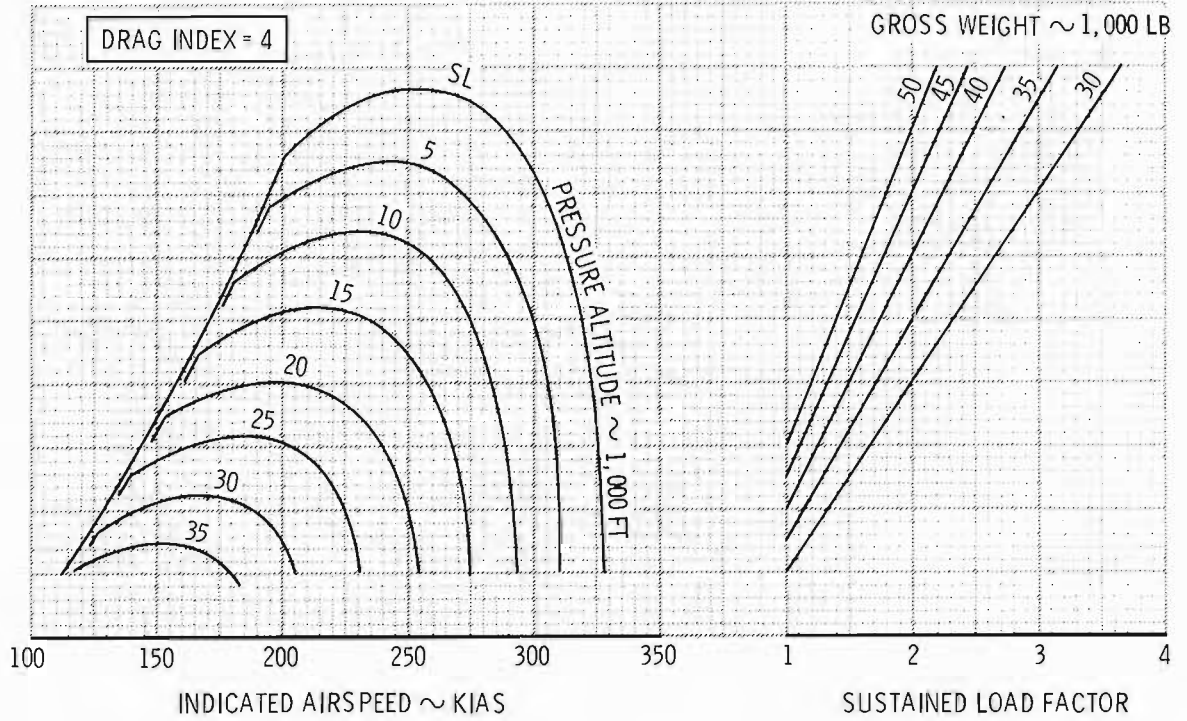
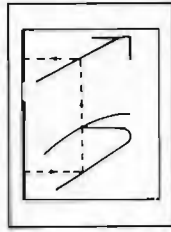
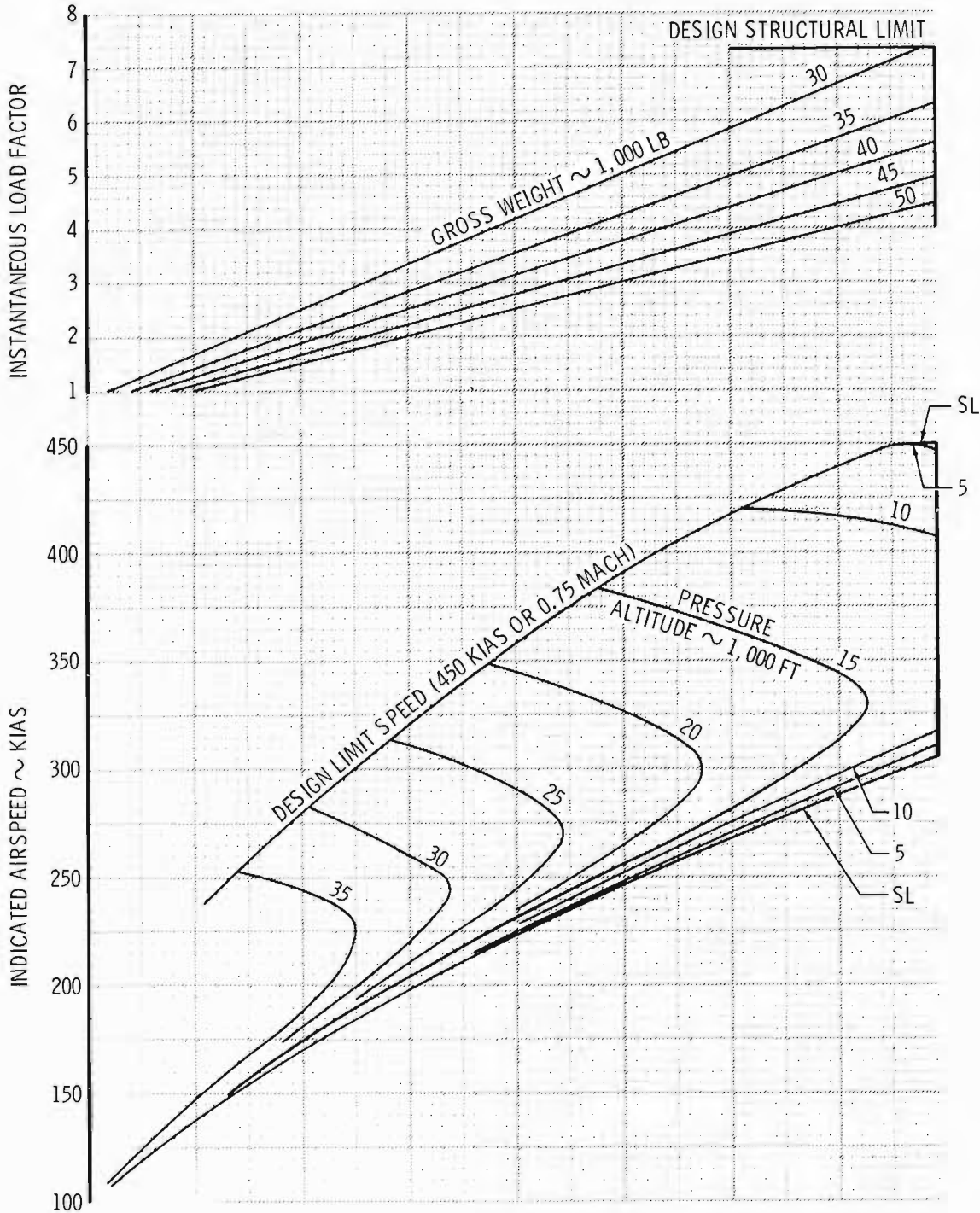

Figure A6-7 (Sheet 2 of 2)

**INSTANTANEOUS
TURN PERFORMANCE**



MODEL : A-10A
DATE : 30 NOVEMBER 1982
DATA BASIS : A . F. FLIGHT TEST
ENGINES : (2) TF34-GE-100/-100A



A1-1-10A-6-9

Figure A6-8

MODEL : A-10A
 DATE : 30 NOVEMBER 1982
 DATA BASIS : A . F . FLIGHT TEST
 ENGINES : (2) TF34-GE-100-100A

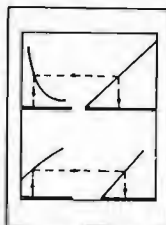

**TURN RADIUS
 and
 TURN RATE**

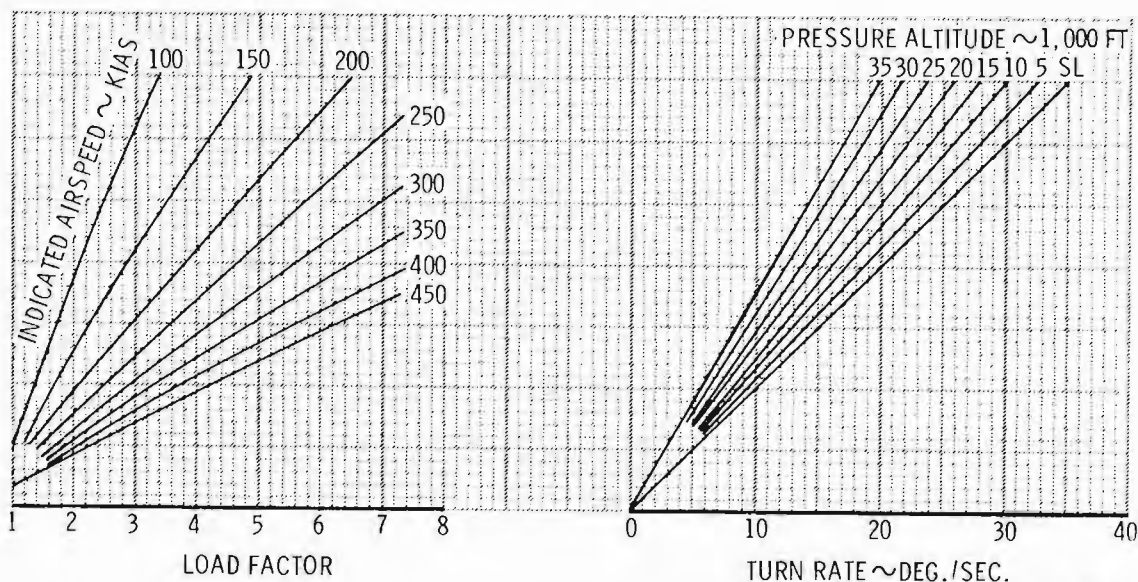
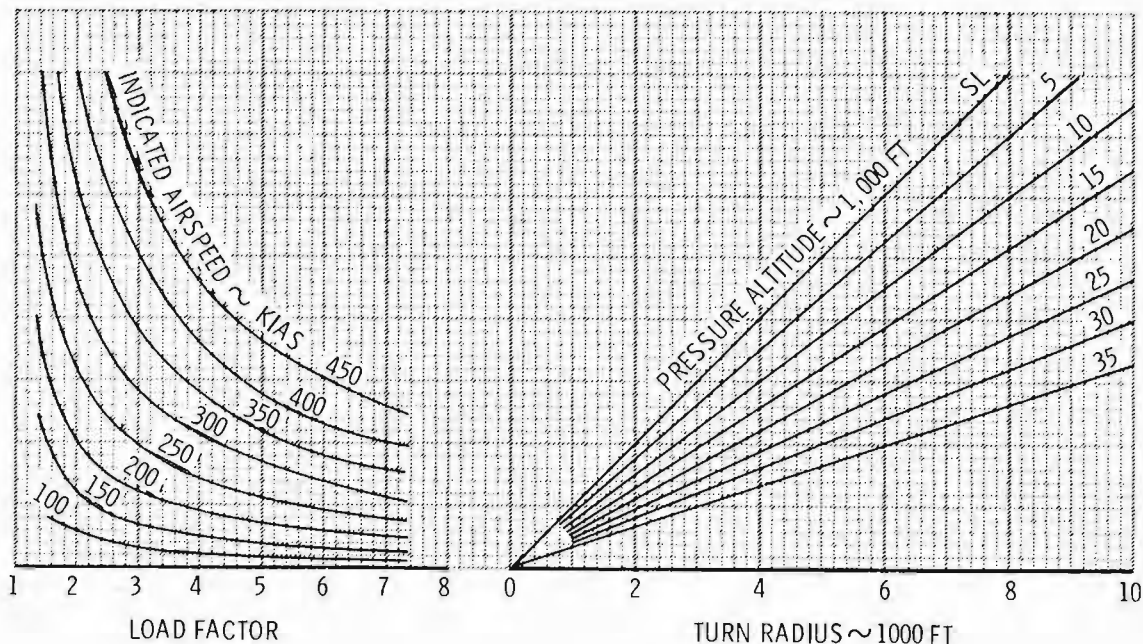

B 1-1-10A-6-10

Figure A6-9

**ALTITUDE LOST
IN
DIVE RECOVERY**

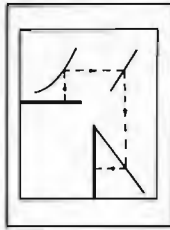

MODEL : A-10A
 DATE : 30 NOVEMBER 1982
 DATA BASIS : A.F. FLIGHT TEST
 ENGINES : (2) TF34-GE-100/-100A

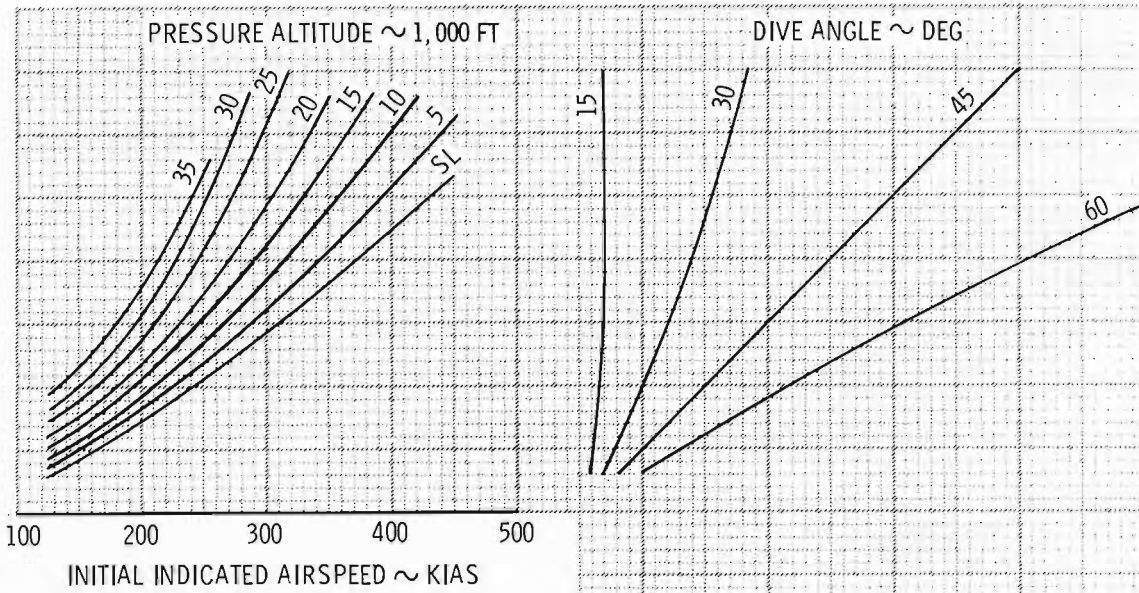

- NOTES
- A 2-second delay is included to allow for buildup to recovery load factor.
 - Consult figure A6-8 to obtain the maximum recovery load factor for a given airspeed, altitude, and gross weight.

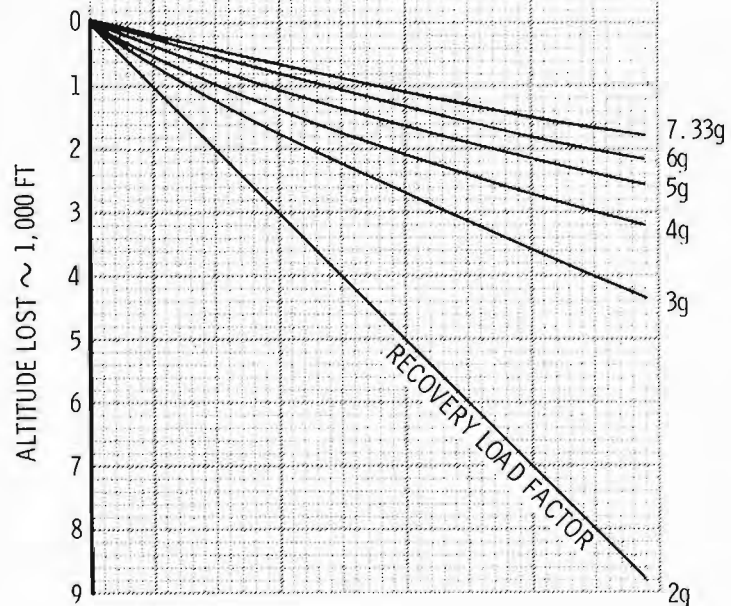

A 1-1-10A-6-11

Figure A6-10

PART VII

DESCENT

TABLE OF CONTENTS

	<u>Page</u>
Maximum Range Descent Charts	A7-1
Penetration Descent Charts	A7-3

LIST OF CHARTS

<u>Figure</u>		<u>Page</u>
A7-1	Maximum Range Descent	A7-5
A7-2	Penetration Descent	A7-8

MAXIMUM RANGE DESCENT CHARTS

Maximum range descent performance data are presented on figure A7-1, sheets 1, 2, and 3. These charts provide a means of determining fuel used, time elapsed, and distance traveled during a descent to sea level or between any two altitudes for any conditions of aircraft gross weight and configuration indicated. The data are based on a descent speed that results in maximum distance (range) being covered during descent. Effects of gross weight, drag index, and temperature variation from standard day are shown in the charts. The descent is performed at idle thrust setting, with speed brakes closed, and at the speed schedule shown on figure A7-1, sheet 1.

DIRECTIONS FOR USE OF CHARTS

Enter sheet 1 at initial gross weight, proceed horizontally to the right to the pressure altitude, drop down to the required drag index, and then project to the left to read fuel used in the descent (standard day). For descent speed, enter the lower grid with initial gross weight, proceed horizontally to the right to drag index, and then project down to read the descent speed.

For elapsed time during standard day descent, enter sheet 2 with gross weight, proceed to the right to pressure altitude, and then drop down to the drag index. From this point, proceed to the left to read the elapsed time. Enter sheet 3 at initial gross weight and proceed horizontally to the right to the pressure altitude, and then drop vertically to the required drag index. Proceed to the left to read the distance traveled during a standard day descent.

To determine fuel, time, and distance for non-standard day descents, contour guide-lines to the desired temperature variations from standard day, and read fuel, time, and distance. To determine fuel, time, and distance required to descend from a higher altitude to a lower altitude (other than sea level) take the difference between the values read at the two altitudes.

Sample Problem

Given:

- A. Aircraft gross weight = 35,000 lb
- B. Drag index = 4

C. Initial altitude = 25,000 ft

D. Temperature variation from standard day = +10°C

Calculate:

A. Fuel, time, distance, and speed for a standard day maximum range descent from initial altitude to sea level

B. Use maximum range descent, fuel used and speed, figure A7-1, sheet 1

1. Gross weight 35,000 lb
2. Pressure altitude 25,000 ft
3. Drag index 4
4. Go to temperature baseline
5. Temperature variation from standard day +10°C
6. Fuel used 115 lb
7. Gross weight 35,000 lb
8. Drag index 4
9. Speed 155 KIAS

C. Use maximum range descent, time, figure A7-1, sheet 2

1. Gross weight 35,000 lb
2. Pressure altitude 25,000 ft
3. Drag index 4
4. Go to temperature baseline
5. Temperature variation from standard day +10°C
6. Time 14 min

D. Use maximum range descent, distance, figure A7-1, sheet 3

1. Gross weight 35,000 lb
2. Pressure altitude 25,000 ft
3. Drag index 4
4. Go to temperature baseline
5. Temperature variation from standard day +10°C
6. Distance 41 NM

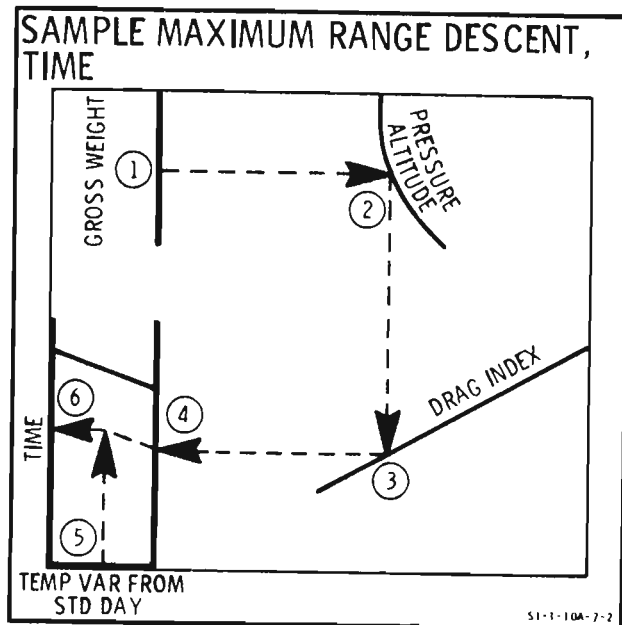
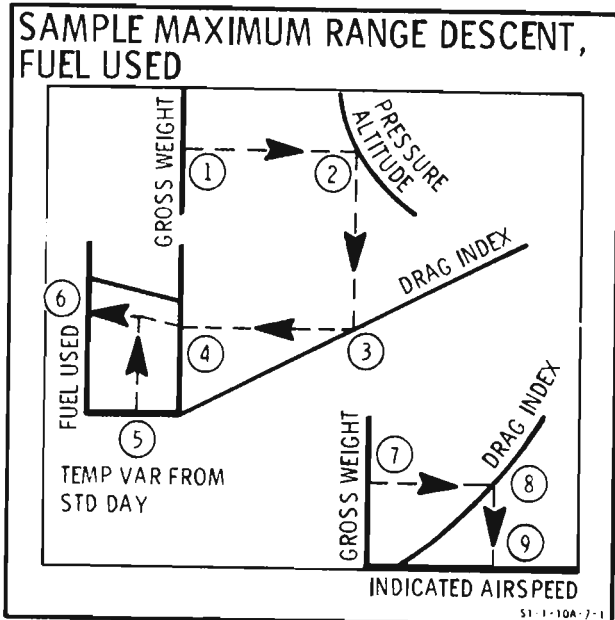

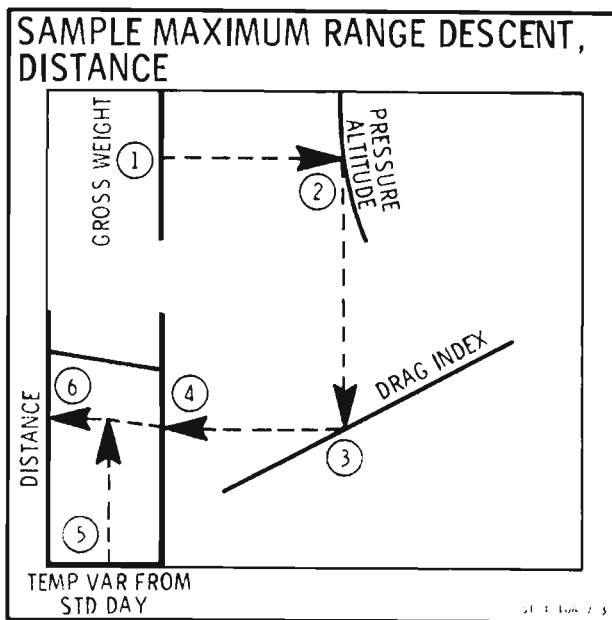

PENETRATION DESCENT CHARTS

Penetration descent performance data are presented on figure A7-2, sheets 1 and 2. These charts provide a means of determining the fuel used, time elapsed, and distance traveled during a penetration descent to sea level or between any two altitudes, for any conditions of aircraft weight and configuration indicated. Effects of gross weight, drag index, and temperature variation from standard day are shown on the charts. The data are based on a descent speed of 200 KIAS, speed brakes open 40%, and a power setting of 80% core rpm.

DIRECTIONS FOR USE OF CHARTS

Enter sheet 1 with initial aircraft weight, proceed horizontally to the right to the pressure altitude, and then drop vertically to the required drag index. At this point, proceed horizontally to the left to read the fuel used in a standard day descent. Enter sheet 2 with initial aircraft weight, proceed to the right to the pressure altitude, and then drop vertically to the required drag index. Read time elapsed and distance traveled in a standard day descent to the left of each plotted drag index. To determine fuel, time, and distance for a non-standard day descent, contour guidelines to the desired temperature variation from

standard day, and read fuel, time, and distance. To determine fuel, time, and distance required for a penetration descent from a higher altitude to a lower altitude (other than sea level), take the difference between the values read at the two altitudes.

Sample Problem

Given:

- A. Aircraft gross weight = 35,000 lb
- B. Drag index = 4
- C. Pressure altitude = 25,000 ft
- D. Temperature variation from standard day = +10°C

Calculate:

- A. Fuel, time, and distance for a standard day +10°C penetration descent at 200 KIAS, speed brakes open 40%, 80% core rpm, from 25,000 feet to sea level.
- B. Use penetration descent, fuel used, figure A7-2, sheet 1

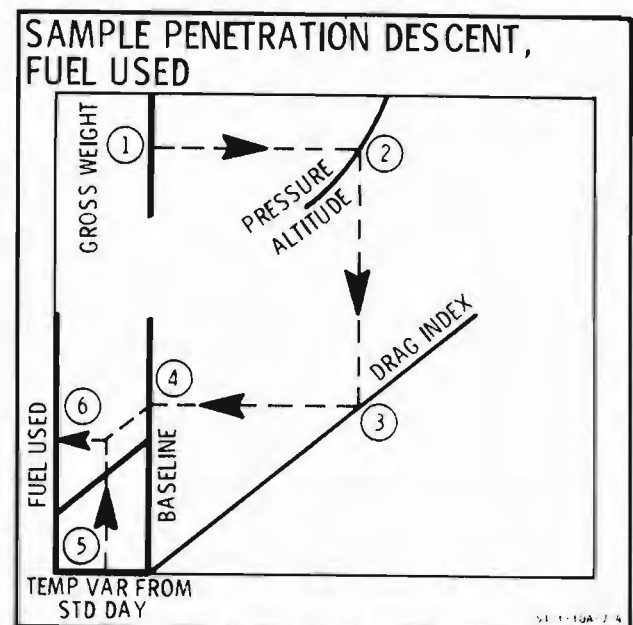

T.O. 1A-10A-1-1

- | | | | |
|--|-----------|--|-------|
| 1. Gross weight | 35,000 lb | 8. Go to temperature baseline | |
| 2. Pressure altitude | 25,000 ft | 9. Temperature variation from standard day | +10°C |
| 3. Drag index | 4 | 10. Distance | 29 NM |
| 4. Go to temperature baseline | | | |
| 5. Temperature variation from standard day | +10°C | | |
| 6. Fuel used | 210 lb | | |

C. Use penetration descent, time and distance, figure A7-2, sheet 2

- | | |
|--|-----------|
| 1. Gross weight | 35,000 lb |
| 2. Pressure altitude | 25,000 ft |
| 3. Drag index | 4 |
| 4. Go to temperature baseline | |
| 5. Temperature variation from standard day | +10°C |
| 6. Time | 7 min |
| 7. Drag index | 4 |

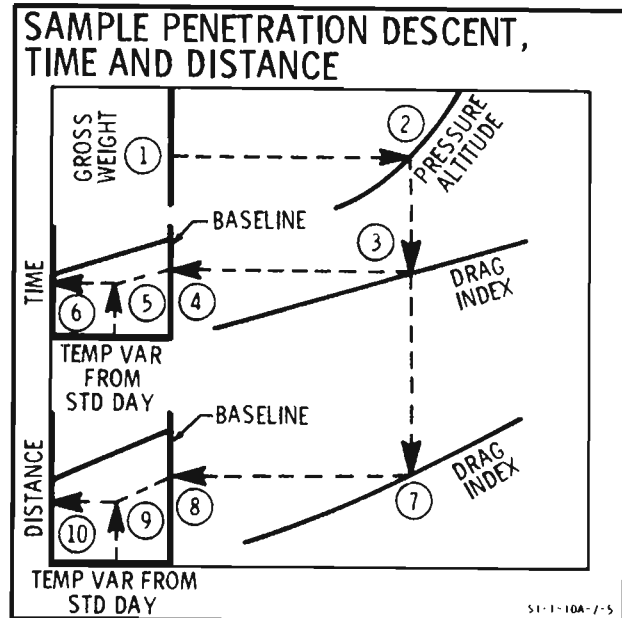

MODEL : A-10A
 DATE : 30 NOVEMBER 1982
 DATA BASIS : A.F. FLIGHT TEST
 ENGINES : (2) TF34-GE-100/-100A

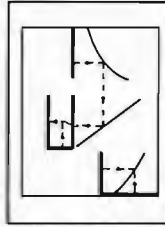

MAXIMUM RANGE DESCENT
 -Fuel Used, Speed Schedule-
 Idle Thrust,
 Speed Brakes Closed

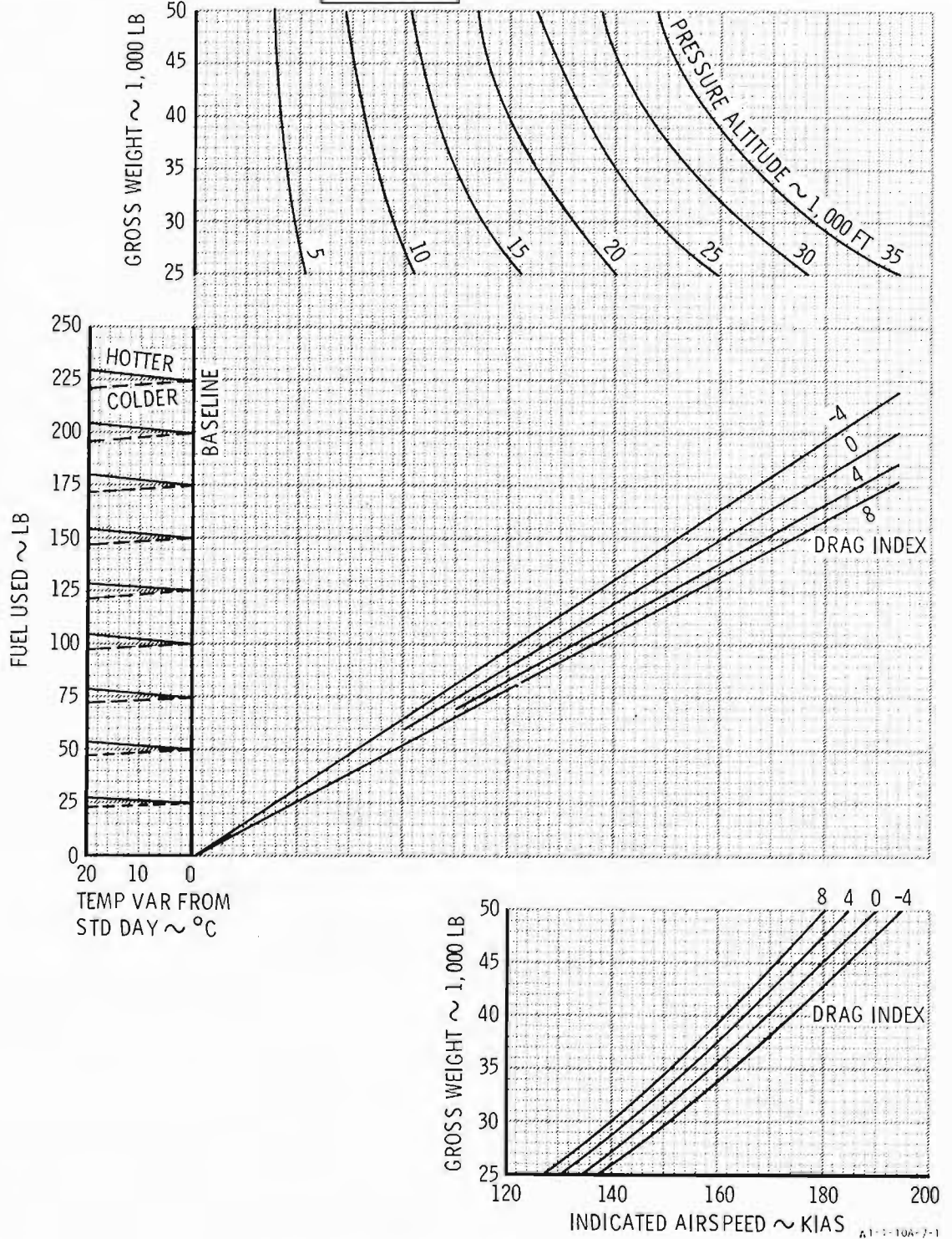
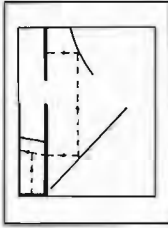
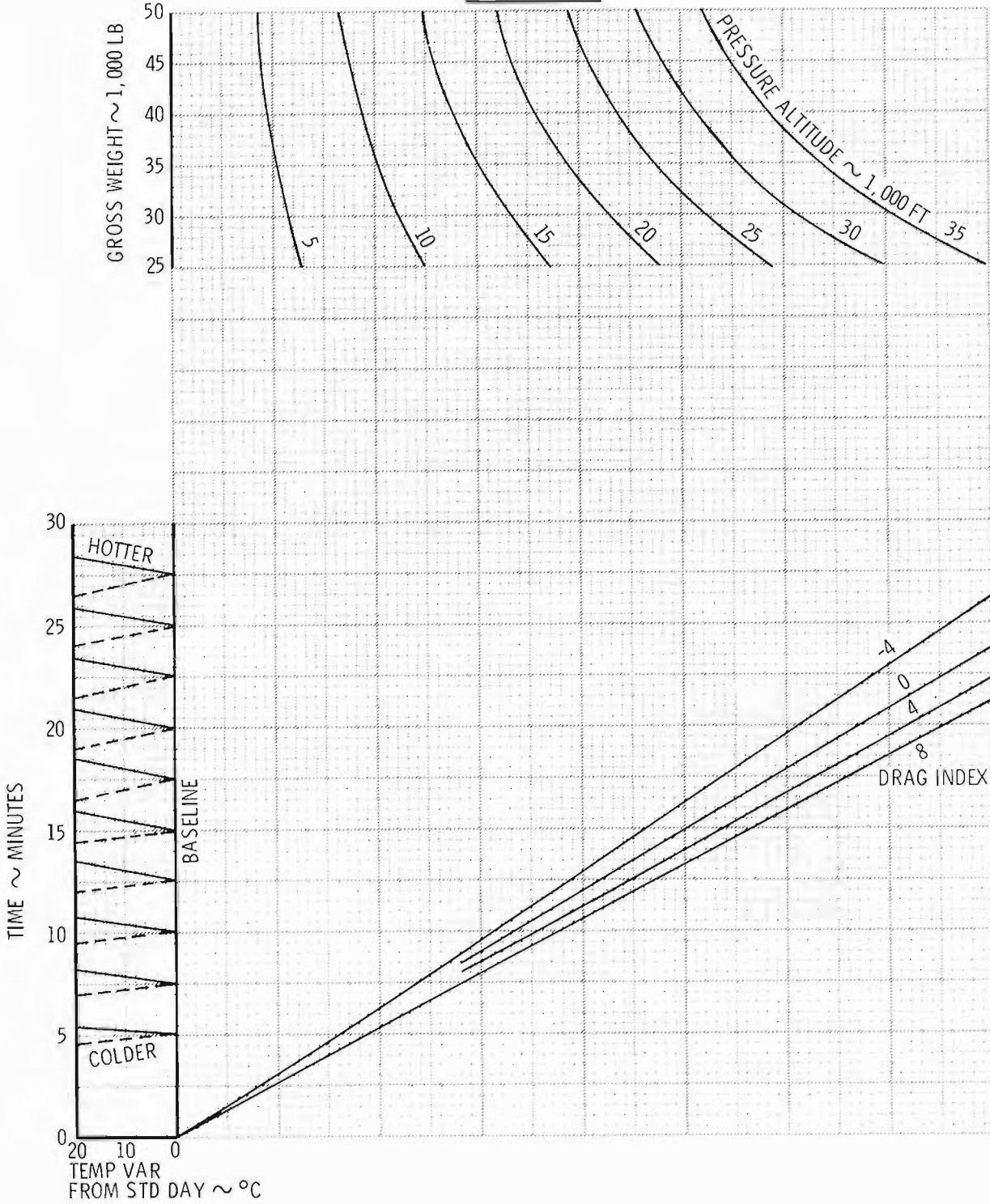

Figure A7-1 (Sheet 1 of 3)

MAXIMUM RANGE DESCENT
-Time-
Idle Thrust,
Speed Brakes Closed



MODEL : A-10A
DATE : 30 NOVEMBER 1982
DATA BASIS : **A.F. FLIGHT TEST**
ENGINES : (2) TF34-GE-100/-100A



A1-1-10A-1-2

Figure A7-1 (Sheet 2 of 3)

MODEL : A-10A
 DATE : 30 NOVEMBER 1982
 DATA BASIS : **A . F . FLIGHT TEST**
 ENGINES : (2) TF34-GE-100/-100A

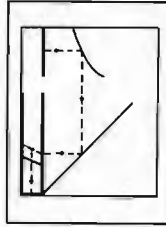

MAXIMUM RANGE DESCENT
 -Distance-
 Idle Thrust,
 Speed Brakes Closed

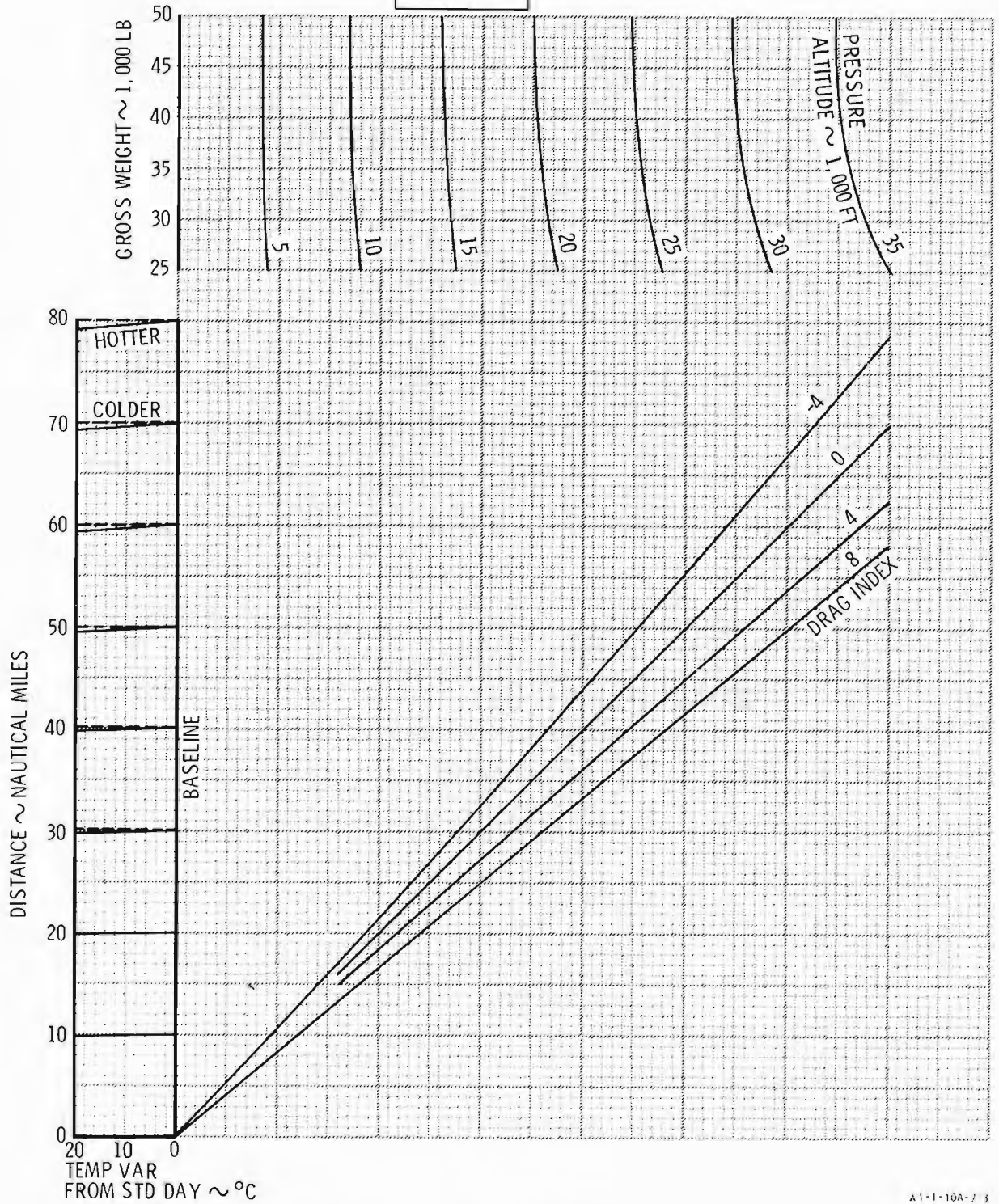

A1-1-10A-7 3

Figure A7-1 (Sheet 3 of 3)

PENETRATION DESCENT
-Fuel Used-
80% Core RPM
Speed Brakes Open 40%
200 KIAS

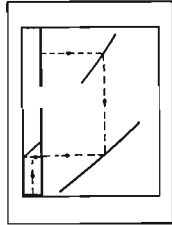

MODEL : A-10A
DATE : 30 NOVEMBER 1982
DATA BASIS : **A . F . FLIGHT TEST**
ENGINES : (2) TF34-GE-100/-100A

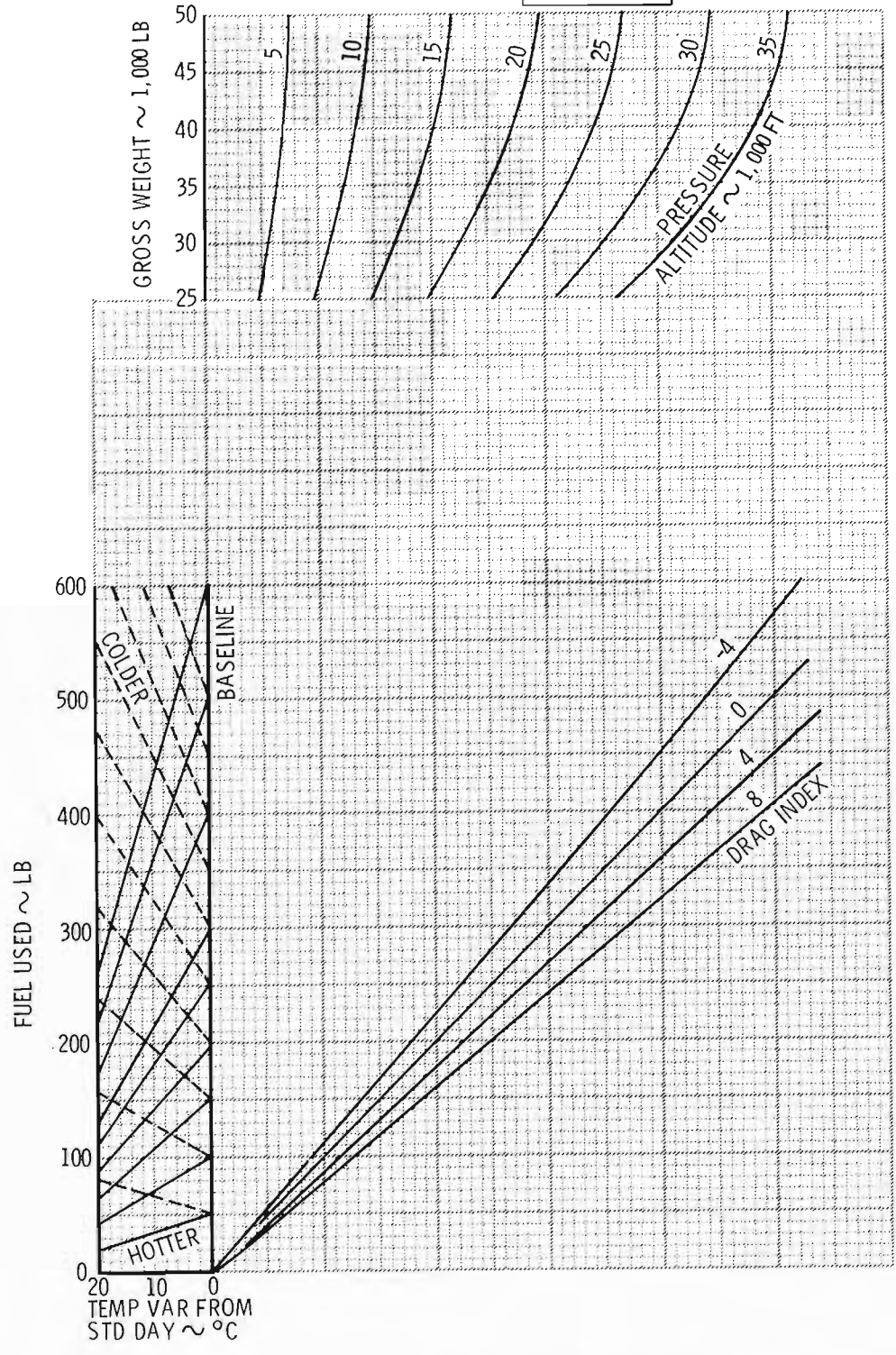

A1-1-10A-7-4

Figure A7-2 (Sheet 1 of 2)

MODEL : A-10A
 DATE : 30 NOVEMBER 1982
 DATA BASIS : A . F . FLIGHT TEST
 ENGINES : (2) TF34-GE-100/-100A

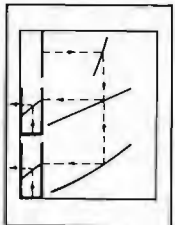

PENETRATION DESCENT
 - Time And Distance -
 80% Core RPM
 Speed Brakes Open 40%
 200 KIAS

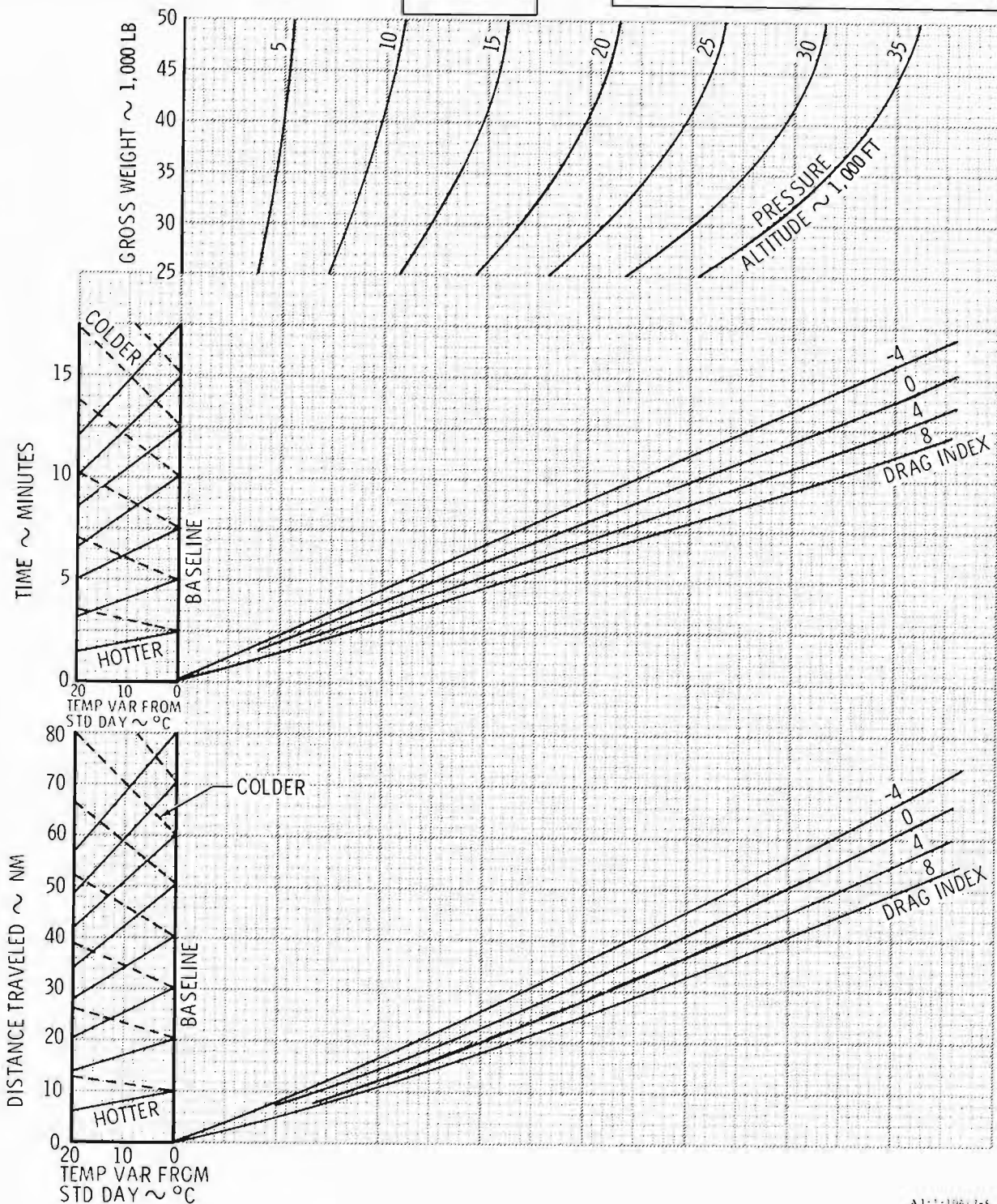

A1-10A-7-5

Figure A7-2 (Sheet 2 of 2)

PART VIII

LANDING

TABLE OF CONTENTS

	<u>Page</u>
Landing Charts (General)	A8-1
Approach Speed Chart	A8-1
Landing Index and Air Distance Chart	A8-2
Landing Ground Roll Distance Charts	A8-3

LIST OF CHART

<u>Figure</u>		<u>Page</u>
A8-1	Final Approach Speed	A8-5
A8-2	Landing Index and Air Distance	A8-6
A8-3	Landing Ground Roll Distance, Flaps 20°, Speed Brakes Open 100%	A8-7
A8-4	Landing Ground Roll Distance, Flaps 0°, Speed Brakes Closed	A8-8
A8-5	Landing Ground Roll Distance, Flaps 20°, Speed Brakes Closed	A8-9

LANDING CHARTS (GENERAL)

The landing charts provide a means of determining requirements for approach speed, air distance from 50-foot obstacle clearance to touchdown, touchdown speed, and ground roll distance using optimum braking. The landing ground roll distance charts are divided into two groups: those that include the effect of speed brakes opened 100%, and those that include the effect of speed brakes closed. All landing data is shown for flaps 0° and 20° at recommended operational landing speeds and also for minimum run landing with flaps 20°. Drag for externally loaded configurations has been accounted for at various aircraft gross weights.

Note

Refer to runway wind components chart, figure A2-15.

APPROACH SPEED CHART

The approach speed chart, figure A8-1, presents the recommended approach speeds as a function of aircraft gross weight and flap deflection. In addition, the approach speeds for minimum run landing are shown with flaps deflected 20°. To obtain touchdown speed, decrease dual-engine approach speed by 10 knots. Single-engine approach speeds are also presented on the chart.

DIRECTIONS FOR USE OF CHART

To obtain dual-engine approach speed, enter the chart with landing gross weight, proceed vertically up to the desired flap deflection, and then horizontally to the left and read approach speed. To obtain touchdown speed, decrease the dual-engine approach speed by 10 knots.

Sample Problem

Given:

- A. Landing gross weight = 30,000 lb
- B. Flap deflection = 20°

Calculate:

- A. Approach and touchdown speeds for normal operation
- B. Use approach speed chart, figure A8-1

- | | |
|---|-----------|
| 1. Gross weight | 30,000 lb |
| 2. Flap deflection | 20° |
| 3. Approach speed | 120 KIAS |
| 4. Touchdown speed (120 KIAS - 10 KIAS) | 110 KIAS |

LANDING INDEX AND AIR DISTANCE CHART

The landing index and air distance chart is presented on figure A8-2 for flaps 20° at

recommended speeds. The effects of runway temperature and pressure altitude on landing distances are combined into one quantity, called the landing index. The landing index is determined for the particular conditions of the problem and then used to define the air distance from 50-foot obstacle clearance to touchdown. Corrections for flaps 0°, speeds at minimum run landing with flaps 20°, and wind components are contained on the chart. The landing index is also used to enter the landing ground roll distance charts that follow.

DIRECTIONS FOR USE OF CHART

Enter the chart with the runway temperature, proceed horizontally to the right to pressure altitude, and then move down to read the landing index. At this value of landing index, continue down to aircraft gross weight, and then proceed horizontally to the left to read the zero wind air distance (from 50-foot obstacle to touchdown). To this value read from the chart, the corrections for wind components or flap deflection must be added, if applicable.

Sample Problem

Given:

- A. Landing gross weight = 30,000 lb
- B. Flap deflection = 20°
- C. Runway temperature = 10°C
- D. Pressure altitude = 2,000 ft
- E. Headwind = 10 kt

Calculate:

- A. Landing index and air distance from 50-foot obstacle to touchdown for flaps 20° at minimum recommended speeds.

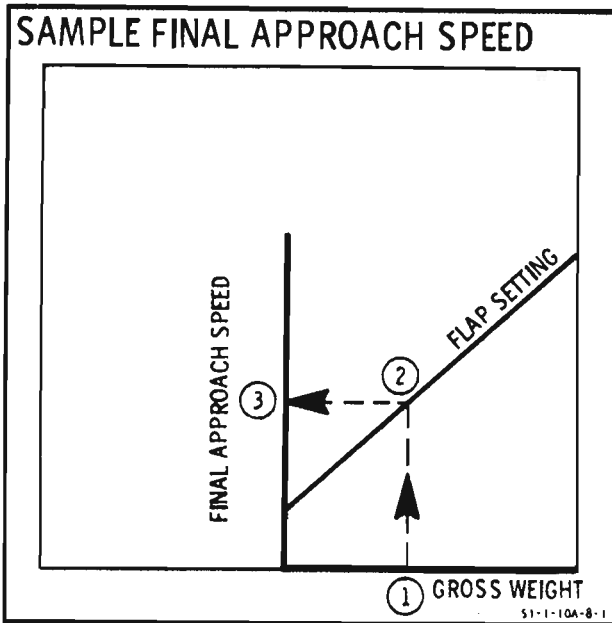

B. Use landing index and air distance chart, figure A8-2

- | | |
|--|-----------|
| 1. Runway temperature | 10°C |
| 2. Pressure altitude | 2,000 ft |
| 3. Landing index | 94.8 |
| 4. Gross weight | 30,000 lb |
| 5. Air distance (from 50-foot obstacle to touchdown) - Zero wind | 1,205 ft |
| Air distance (from 50-foot obstacle to touchdown) - 10 kt headwind | |
| 1,205 ft - (10 kt x 10 ft/kt) | 1,105 ft |

brakes open 100% and closed, respectively. Figure A8-4 presents landing ground roll distance data for flaps 0° and speed brakes closed. These charts are shown as a function of landing index, landing gross weight, runway wind component, runway slope, and RCR. The landing ground roll distance is based on optimum braking throughout the ground roll on a hard-surfaced runway following a 3-second "free roll" period. The "free roll" period is necessary to establish the optimum braking condition. Ground roll distance, with speed brakes open 100%, is based on the "free roll" with speed brakes open 40%, and the remaining ground roll with speed brakes open 100% and full braking. Ground roll distance with speed brakes closed is based on the entire distance from touchdown to full stop with speed brakes closed.

Note

Landing ground roll distances may be used for single-engine planning, provided dual-engine touchdown speeds are achieved.

LANDING GROUND ROLL DISTANCE CHARTS

The landing ground roll distance charts with flaps 20° at recommended speeds are presented on figures A8-3 and A8-5, for speed

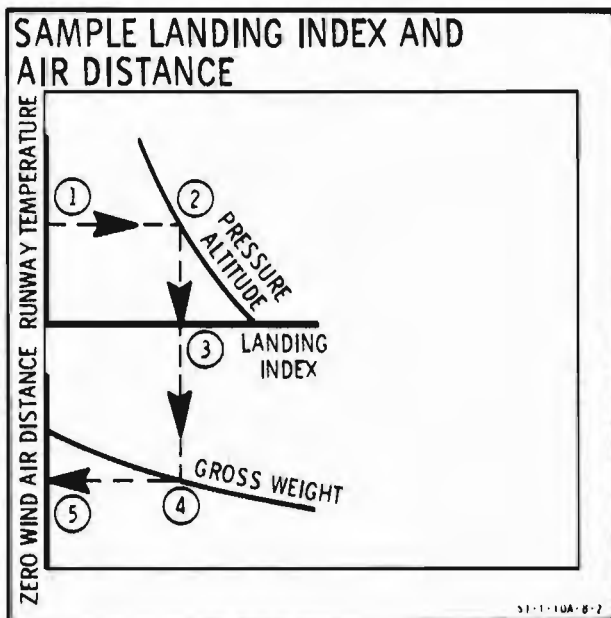

DIRECTIONS FOR USE OF CHARTS

Enter the appropriate chart with landing index, proceed horizontally to the right to gross weight, and then drop down to the wind baseline. Move down, contouring the appropriate guidelines (headwind or tailwind) to the wind velocity, and then drop down to the runway slope baseline. Contour the appropriate guidelines (uphill or downhill) to the runway slope, and then move down to the RCR baseline. Contour the nearest guidelines to the RCR and then continue down to read the landing ground roll distance. If operating on a dry, hard-surfaced runway with anti-skid system operational, proceed directly through the RCR portion of the chart. The corrections noted on the charts can now be applied to this chart value.

Sample Problem

Given:

- A. Runway temperature = 10°C
- B. Pressure altitude = 2,000 ft
- C. Landing gross weight = 30,000 lb
- D. Runway headwind = 10 kt
- E. Runway slope = 1% uphill
- F. RCR = 16

Calculate:

- A. Landing ground roll distance with flaps 20° at recommended speeds, and speed brakes open 100%
- B. Use landing ground roll distance chart, figure A8-3.

- 1. Landing index (from figure A8-2) 94.8
- 2. Landing gross weight 30,000 lb
- 3. Go to wind baseline
- 4. Runway headwind 10 kt

- 5. Go to runway slope baseline
- 6. Runway slope 1% uphill
- 7. Go to RCR baseline
- 8. RCR 16
- 9. Landing ground roll distance 2,300 ft

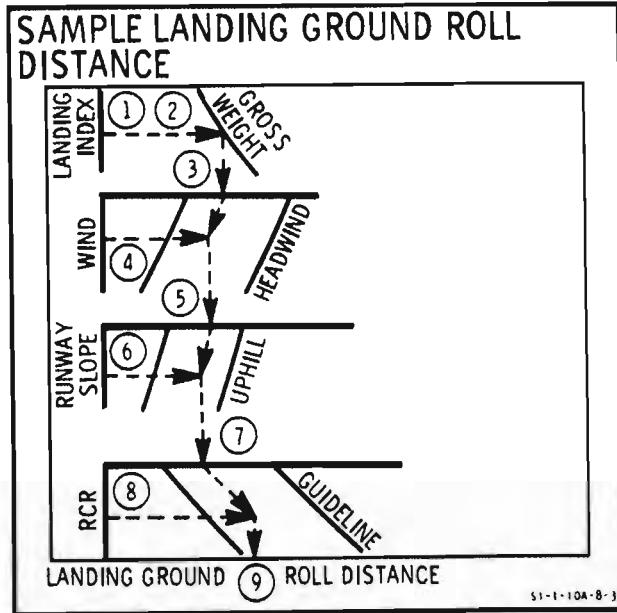

MODEL : A-10A
 DATE : 30 NOVEMBER 1982
 DATA BASIS : **A . F. FLIGHT TEST**
 ENGINES : (2) TF34-GE-100/-100A

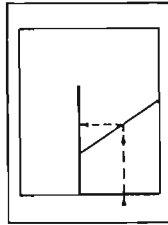

FINAL APPROACH SPEED

NOTES



- Subtract 10 knots from dual-engine final approach speed to obtain touchdown speed, except for minimum run.
- Single-engine final approach speed is maintained until landing is assured.

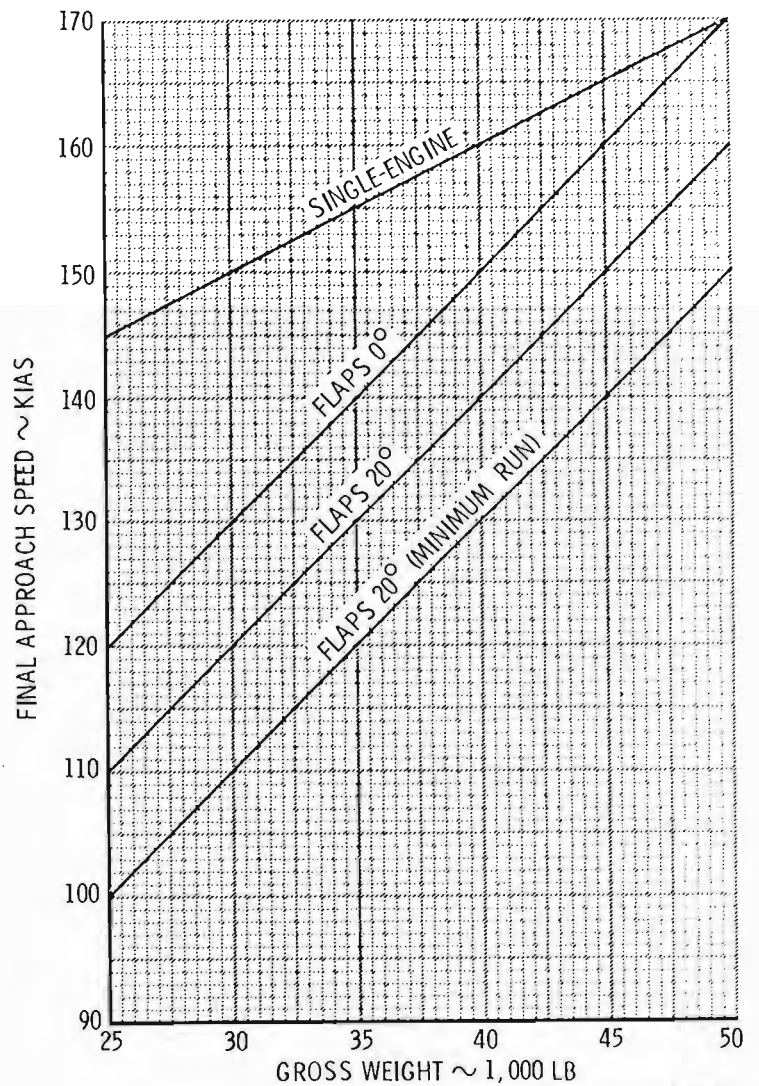
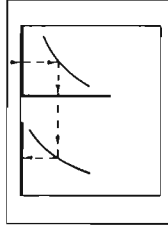

Figure 8-1

**LANDING INDEX
AND
AIR DISTANCE
For Flaps 20°,
Recommended Speeds**



MODEL : A-10A
DATE : 30 NOVEMBER 1982
DATA BASIS : **A.F. FLIGHT TEST**
ENGINES : (2) TF34-GE-100/-100A



- NOTES
- With flaps 0° increase air distance by 100 feet.
 - At speeds for minimum run with flaps 20°, decrease air distance by 150 feet.
 - Decrease (increase) air distance by 10 feet per 1 knot headwind (tailwind).

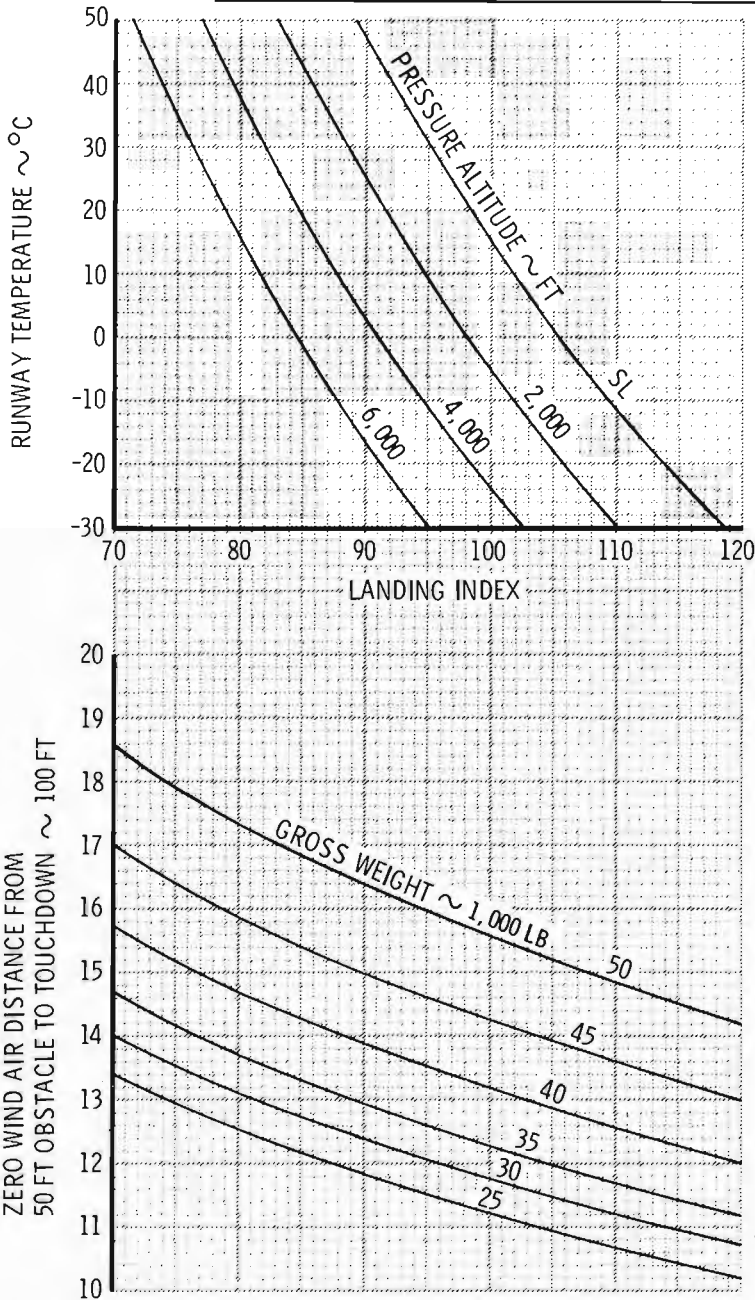
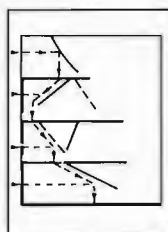

Figure A8-2

MODEL : A-10A
 DATE : 30 NOVEMBER 1982
 DATA BASIS : **A.F. FLIGHT TEST**
 ENGINES : (2) TF34-GE-100/-100A



LANDING GROUND ROLL DISTANCE
Flaps 20°
Speed Brakes Open 100%

RCR	CONDITION
23	DRY
12	WET
5	ICY



WARNING

Landing ground roll distances obtained for RCR's less than 12 are estimated and have not been substantiated by flight test data.

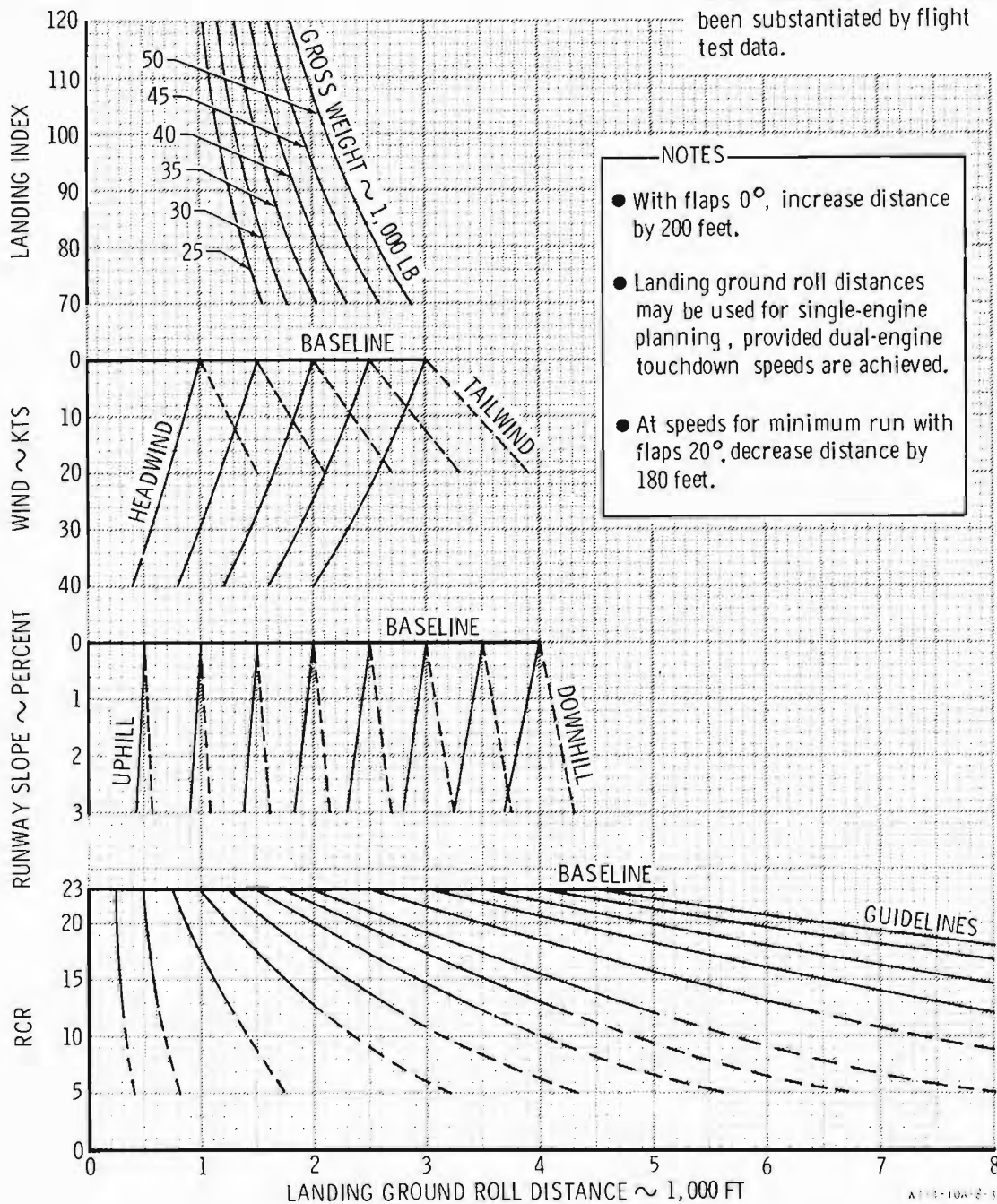
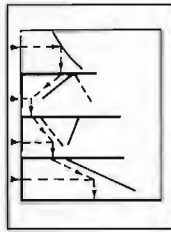

Figure A8-3

LANDING GROUND ROLL DISTANCE
Flaps 0°
Speed Brakes Closed

RCR	CONDITION
23	DRY
12	WET
5	ICY



MODEL : A-10A
 DATE : 30 NOVEMBER 1982
 DATA BASIS : **A . F . FLIGHT TEST**
 ENGINES : (2) TF34-GE-100/-100A

WARNING



Landing ground roll distances obtained for RCR's less than 12 are estimated and have not been substantiated by flight test data.

NOTE

- Landing ground roll distances may be used for single-engine planning, provided dual-engine touchdown speeds are achieved.

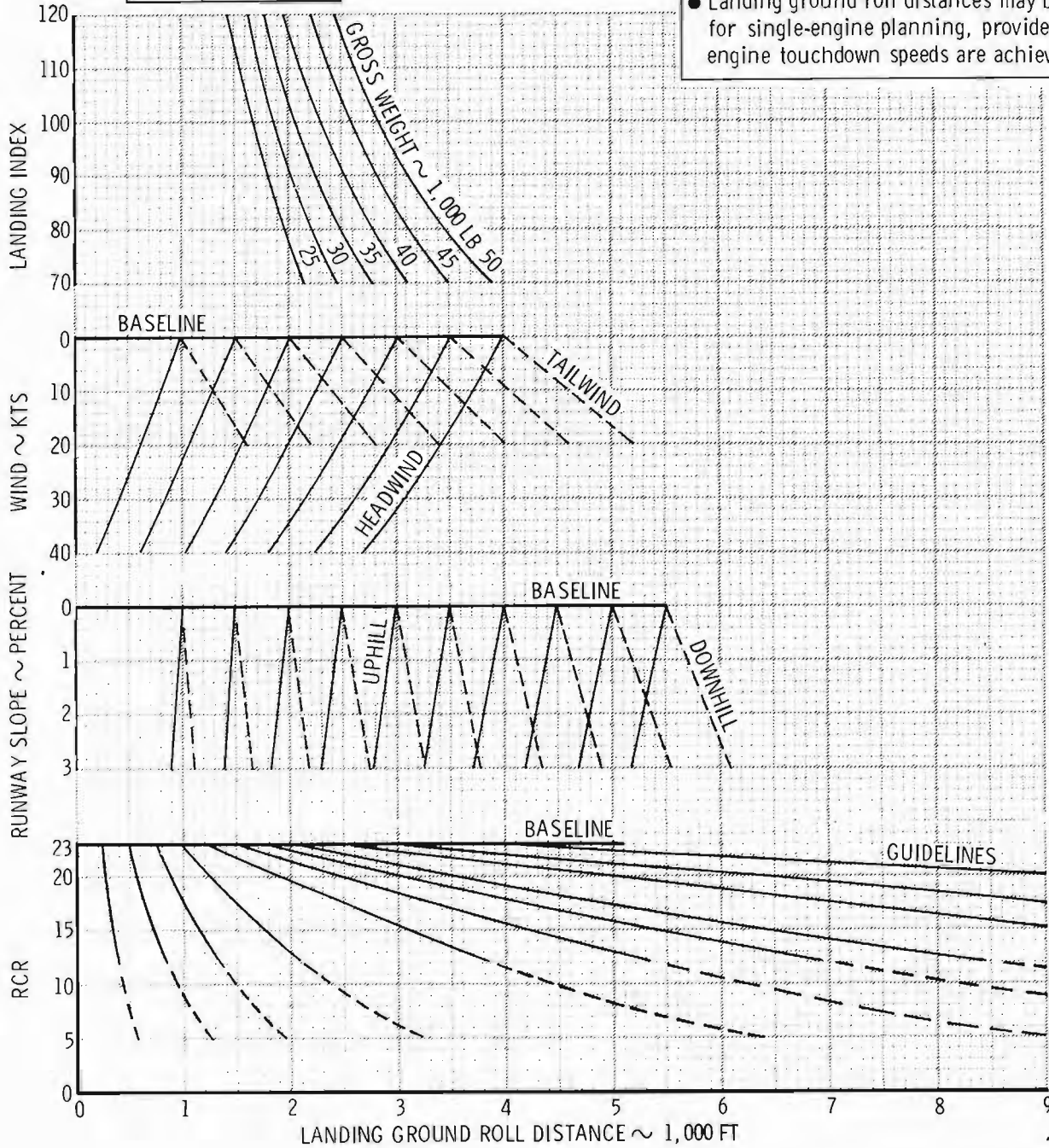

A1-1-10A-8-4

Figure A8-4

MODEL : A-10A
 DATE : 30 NOVEMBER 1982
 DATA BASIS : **A.F. FLIGHT TEST**
 ENGINES : (2) TF34-GE-100/-100A

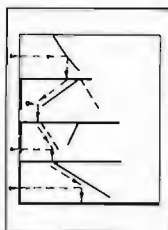

LANDING GROUND ROLL DISTANCE
Flaps 20°
Speed Brakes Closed

RCR	CONDITION
23	DRY
12	WET
5	ICY

WARNING

Landing ground roll distances obtained for RCR's less than 12 are estimated and have not been substantiated by flight test data.

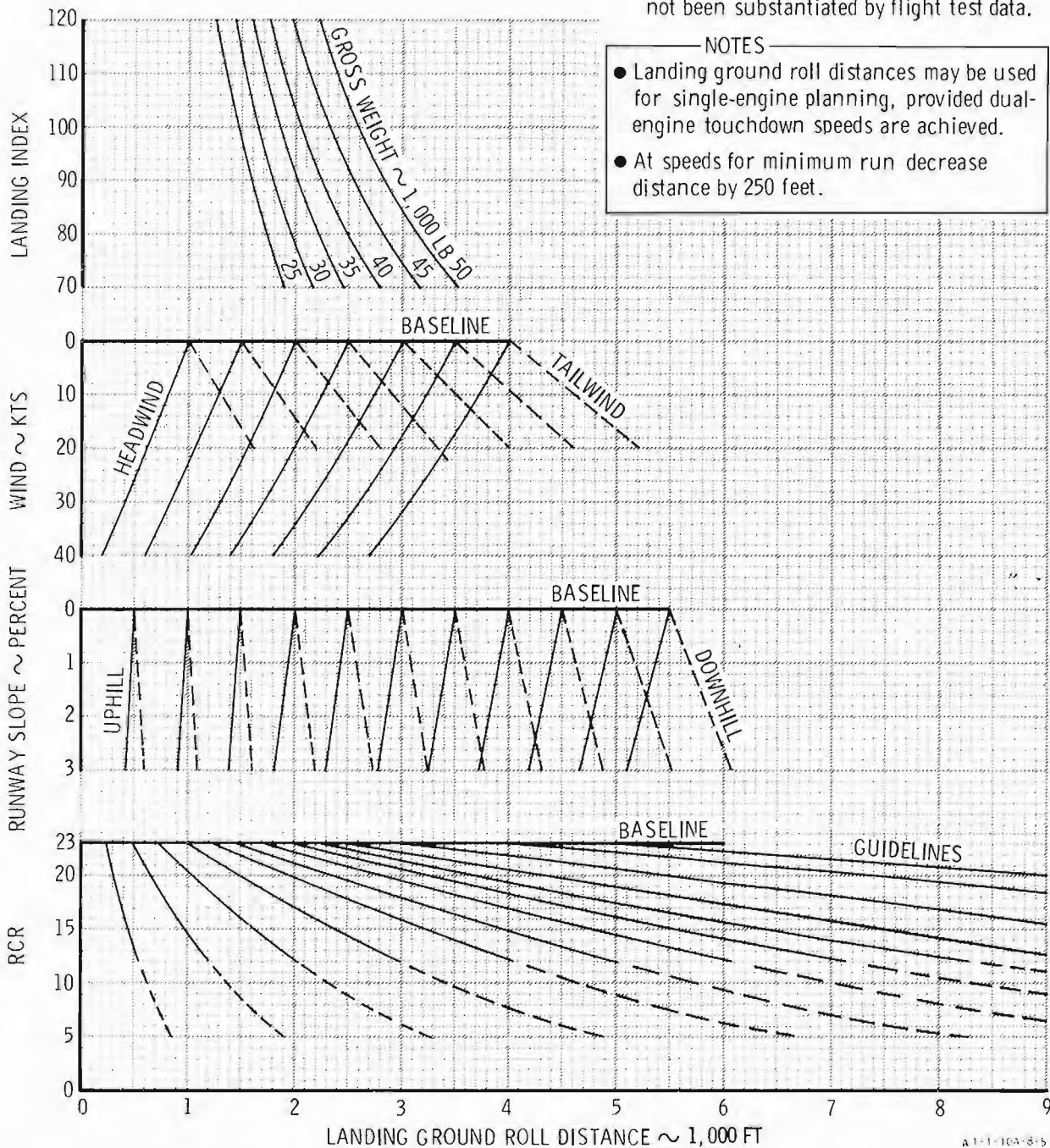

Figure A8-5

PART IX

MISSION PLANNING

TABLE OF CONTENTS

	<u>Page</u>
Purpose	A9-1
Mission Planning Sample Problems	A9-1

LIST OF CHARTS

<u>Figure</u>	<u>Page</u>
A9-1 Sample Inflight Data Log	A9-16
A9-2 Sample Takeoff and Landing Data Card	A9-17

PURPOSE

The purpose of mission planning is to illustrate how the performance information contained in parts I through VIII are integrated to plan any specific mission and to obtain optimum performance for that mission. Optimum performance will vary, for example, from maximum time on station to maximum radius with no time on station. Exact performance requirements will vary, depending on the type of mission to be flown. Sample problems are presented in this part to illustrate how the charts contained in parts I through VIII are used.

MISSION PLANNING SAMPLE PROBLEMS

Note

The following sample mission is an exercise in the use of the performance charts. It is not intended to reflect actual or proposed operational missions.

FERRY MISSION, CONSTANT ALTITUDE CRUISE PROFILE

The problem is to determine the ferry range available for an A-10A configured with two full 600-gallon external fuel tanks on stations 4 and 8 and one fully loaded MXU-648 cargo pod on the centerline pylon station. Takeoff is made with maximum thrust followed by a 3% below PTFS climb on course to 20,000 feet altitude. Cruise is performed at 20,000 feet at 300 KTAS. For the purpose of this mission planning section, an arbitrary fuel reserve value of 2,000 pounds fuel was selected. Actual fuel reserves should be planned in accordance with operational directives. Zero wind and standard day conditions are assumed throughout the mission. Zero time and distance are assumed during descent and landing.

Supplemental Data

- A. The loaded gross weight with 11 pylons, full internal fuel, two full 600-gallon

fuel tanks on stations 4 and 8, and one full MXU-648 cargo pod on centerline station is 45,600 pounds. The weight data for the separate items, obtained from figure A1-1, is tabulated below:

	<u>Wt ~ Lb</u>
A-10A operating weight	25,600
Full internal fuel	10,700
Two 600-gallon fuel tanks	1,102
1200 gallons external fuel	7,800
MXU-648 cargo pod (full)	398
	<hr/>
Total gross weight	45,600

B. The usable fuel load is 18,500 pounds. Aircraft weight with zero fuel on board is 27,100 pounds.

C. The drag index of the aircraft at take-off, obtained from figure A1-1, is 2.45. The individual drag index values are tabulated below:

	<u>Drag Index</u>
A-10A aircraft ~ 11 pylons	0.00
Two 600-gallon fuel tanks	1.72
MXU-648 cargo pod	0.73
	<hr/>
Total aircraft drag index	2.45

General Comments

This type of mission must be worked from both ends, starting with empty (zero fuel) weight and takeoff weight and working toward the weight at the end of the cruise. The weight at the start of cruise minus the weight at the end of cruise determines the fuel available for cruise.

Determination of Gross Weight at End of Cruise

In order to determine the aircraft gross weight at the end of the cruise portion of this mission, the landing fuel reserve of 2,000 pounds must be added to the zero fuel gross weight.

$$\begin{aligned} &\text{End cruise gross weight} \\ &= \text{zero fuel gross weight} \\ &\quad + \text{landing fuel reserve} \\ &= 27,100 \text{ lb} - 2,000 \text{ lb} \\ &= 29,100 \text{ lb} \end{aligned}$$

Start, Taxi, Takeoff, and Acceleration to Climb Speed

The mission is now worked from takeoff to the end of the cruise at 20,000 feet pressure altitude.

Fuel used	500 lb
Distance (brake release to climb speed)	2 NM
Time (brake release to climb speed)	1 min

Climb to Cruise Altitude

Referring to figure A3-2, sheets 1 and 2:

Start climb weight	45,100 lb
Cruise altitude	20,000 ft
Drag index	2.45
Fuel used in climb	940 lb
Time to climb	12 min
Distance to climb	46 NM
Weight at end of climb (initial cruise weight)	44,160 lb

Cruise to Destination

Weight at start of cruise	44,160 lb
Weight at end of cruise	29,100 lb
Fuel available for cruise	15,060 lb
Average cruise weight	36,630 lb
	$44,160 - (15,060 \div 2)$

Cruise altitude	20,000 ft	Climb to Optimum Cruise Altitude	
Cruise speed	300 KTAS	Start climb gross weight	45,100 lb
Cruise Mach no. (from figure A1-5)	0.489	Drag index	2.45
Reference no. (figure A4-4, sheet 1)	10.8	Optimum cruise altitude based on estimated initial cruise gross weight of 43,500 lb (figure A4-1)	27,000 ft
Specific range (NM/lb) (figure A4-4, sheet 2)	0.0960	Fuel used in climb (figure A3-2, sheet 1)	1,580 lb
Cruise range (NM/lb x lb fuel)	1,446 NM	Time to climb (figure A3-2, sheet 2)	24 min

Totals

	<u>Range</u>	<u>Time</u>
Takeoff and accelerate to climb speed	2 NM	1 min
Climb to 20,000 ft	46 NM	12 min
Cruise at 20,000 ft	1,446 NM	289 min
Totals	<u>1,494 NM</u>	<u>302 min</u> (5 hr)

Distance traveled	102 NM
Weight at end of climb (computed initial cruise weight)	43,520 lb

Cruise to Destination

Weight at start of cruise	43,520 lb
Weight at end of cruise	29,100 lb
Fuel available for cruise	14,420 lb
Average cruise gross weight 43,465 - (14,420 ÷ 2)	36,310 lb

FERRY MISSION, OPTIMUM INITIAL ALTITUDE AND LONG RANGE SPEED PROFILE

As an alternate profile, the mission can be performed by climbing to optimum initial altitude and then cruising at long range speed, thereby resulting in greater range. The mission planning sequence is similar to the constant altitude/constant speed mission described previously, except a climb to optimum initial altitude is performed followed by a cruise at long range speed.

End of cruise gross weight	29,100 lb
Total takeoff fuel allowance	500 lb
Start climb gross weight	45,100 lb

Cruise altitude	27,000 ft
Long range cruise Mach no. (figure A4-3, sheet 1)	0.487
Temperature (figure A1-6)	-37.3°F
Long range cruise speed (figure A1-5)	191 KCAS (291 KTAS)
Specific range (NM/lb) (figure A4-3, sheet 2)	0.115
Cruise range (NM/lb x lb fuel)	1,658 NM
Cruise time (NM ÷ KTAS)	5.70 hr

Totals

	<u>Range</u>	<u>Time</u>
Takeoff and accelerate to climb speed	2 NM	1 min
Climb to 27,000 ft	102 NM	24 min
Cruise to 27,000 ft	1,658 NM	342 min
Totals	1,762 NM	367 min (6 hr)

First Cruise Segment (at 27,000 ft)

Start cruise gross weight	43,520 lb
End cruise gross weight (weight that allows climb to desired new optimum altitude of 30,000 ft)	38,850 lb
Average cruise gross weight	41,185 lb
Cruise altitude	27,000 ft
Fuel used	4,611 lb
Drag index	2.45

FERRY MISSION, CRUISE/CLIMB MISSION PROFILE

As a final alternate profile, the mission can be performed by climbing to optimum initial altitude and cruising at maximum range cruise speed. After a sufficient amount of fuel has been used, a climb to a new pre-determined optimum altitude is performed. This procedure is carried out throughout the mission until over the destination, and results in the maximum range available. Changes in cruise altitude can be based on other criteria, such as elapsed time or distance. As in the previous mission profiles, the following data is used:

End cruise gross weight	29,100 lb
Total takeoff fuel allowance	500 lb
Distance from brake release to climb speed	2 NM

Climb to Optimum Cruise Altitude

Start climb gross weight	45,100 lb
Drag index	2.45
Optimum cruise altitude	27,000 ft
Fuel used	1,580 lb
Time	24 min
Distance	102 NM

Cruise Mach no. (maximum range) (figure A4-3, sheet 1)	0.485
Cruise airspeed (maximum range) (figure A1-5)	189 KIAS (289 KTAS)
Specific range (figure A4-4)	0.108 NM/lb
Cruise range (NM/lb x lb fuel)	504 NM
Cruise time (NM ÷ KTAS)	105 min

Climb to New Optimum Cruise Altitude

The fuel required to climb from a lower altitude to a higher altitude is the fuel required to climb from sea level to the higher altitude less the fuel required to climb from sea level to the lower altitude. Time and distance are found in the same manner.

Start climb gross weight	38,850 lb
New cruise altitude	30,000 ft
Fuel used to climb (SL to 30,000)	1,435 lb
Previous cruise altitude	27,000 ft

Fuel used to climb (SL to 27,000)	1,130 lb
Fuel used in climb from 27,000 - 30,000 ft (1,435 lb - 1,130 lb)	305 lb
Initial cruise gross weight (38,850 - 305)	38,545 lb

In a similar manner,

Time (23.5 - 18.0)	5.5 min
Distance (97 - 70)	27 NM

Second Cruise Segment (at 30,000 ft)

Start cruise gross weight	38,545 lb
End cruise gross weight (weight that allows climb to desired new optimum altitude of 35,000)	31,900 lb
Average cruise gross weight	35,223 lb
Fuel used	6,645 lb
Cruise altitude	30,000 ft
Cruise Mach no. (maximum range)	0.480
Cruise airspeed (maximum range)	176 KCAS/ 283 KTAS
Specific range	0.124 NM/lb
Cruise range (NM/lb x lb fuel)	824 NM
Cruise time (NM ÷ KTAS)	175 min

Climb to Final Optimum Cruise Altitude

Proceeding in the same manner as the climb from 27,000 - 30,000 feet, the following data is obtained for a climb from 30,000 - 35,000 feet:

Fuel used in climb (from 30,000 - 35,000 feet)	410 lb
Time to climb	9 min
Distance traveled during climb	45 NM
Initial cruise gross weight (31,900 - 410)	31,490 lb

Final Cruise Segment (at 35,000 ft)

Start cruise gross weight	31,490 lb
End cruise gross weight	29,100 lb
Average cruise gross weight	30,295 lb
Cruise fuel	2,390 lb
Cruise altitude	35,000 ft
Cruise Mach no. (maximum range)	0.480
Cruise airspeed (maximum range)	158 KCAS 277 KTAS
Specific range	0.149 NM/lb
Cruise range (NM/lb x lb fuel)	356 NM
Cruise time (NM ÷ KTAS)	77 min

Totals

	<u>Range</u>	<u>Time</u>
Brake release to climb speed	2 NM	1.0 min
Climb to 27,000 ft	102 NM	24.0 min
Cruise at 27,000 ft	504 NM	105.0 min
Climb to 30,000 ft	27 NM	5.5 min
Cruise at 30,000 ft	824 NM	175.0 min
Climb to 35,000 ft	45 NM	9.0 min
Cruise at 35,000 ft	356 NM	77.0 min
Totals	1,860 NM	396.5 min (6.6 hr)

**CLOSE AIR SUPPORT (CAS) MISSION,
HI LO-HI**

The purpose of this sample problem is to determine the fuel required to perform the specified mission with a given external store loading. The problem includes calculation for start, taxi, takeoff, and acceleration to climb speed, climb to a cruise altitude of 15,000 feet and cruise at 300 KTAS to a target 150 nautical miles from takeoff point. At the target, a 30-minute combat is performed at 300 KTAS, 500 feet, and maximum power. After expending all bombs, ammo, and flares, climb to and cruise at 300 KTAS, and 15,000 feet, for return to home base. Allow a fuel reserve of 2,000 pounds for approach and landing and alternate field requirements. Assume zero wind and standard day temperature conditions. Assume zero time and distance for descents and landing.

Supplemental Data

a. The loaded gross weight with 11 pylons, full internal fuel, six MK-82 LDGP bombs on stations 2, 3, 4, and 8, 9, 10, full ammo, and full load of flares is 41,489 pounds. The individual weight data from figure A1-1 is tabulated below:

	<u>Wt ~ Lb</u>
A-10A operating weight	25,600
Full internal fuel	10,700
Six MK-82 LDGP bombs	3,030
1,174 rounds of 30mm ammunition	1,831
480 M-206 flare cartridges	328
Total aircraft gross weight	41,489

b. The usable fuel load is 10,700 pounds. The weight of the expendable ordnance is 4,513 pounds.

c. The drag index values of the aircraft at takeoff (outbound) and at landing (return), obtained from figure A1-1, are 1.25 and 0.40, respectively. The individual drag index values are tabulated below:

	DRAG INDEX	
	<u>Outbound</u>	<u>Return</u>
A-10A aircraft ~ 11 pylons	0.00	0.00
Six MK-82 LDGP bombs	1.20	0.00
480 M-206 flare cartridges (fully loaded)	0.05	-
480 M-206 flare cartridges (all fired)	-	0.40
Total aircraft drag index	1.25	0.40

General Comments

This type of mission can be solved directly, working from takeoff to landing, as all required conditions are known except fuel required for the mission.

Start, Taxi, Takeoff, and Acceleration to Climb Speed

Fuel used	500 lb
Distance (brake release to climb speed)	2 NM
Time (brake release to climb speed)	1 min

Climb to Cruise Altitude

Using figure A3-1, sheets 1 and 2:

Start climb gross weight	40,989 lb
Cruise altitude	15,000 ft
Drag index	1.25
Fuel used in climb	470 lb
Time during climb	5 min
Distance traveled during climb	18 NM
Gross weight at end of climb (start cruise gross weight)	40,519 lb

Cruise to Target

When the average cruise gross weight is not known initially, as in this sample problem, it may be necessary to obtain a value of cruise fuel first, based on the start cruise weight, and then, reread the charts using the start cruise weight reduced by half of the fuel found for cruise. The cruise distance is computed by subtracting the sum of the distances to takeoff and accelerate and climb to cruise altitude from the desired radius. Using figure A4-4, sheets 1, 2, and 3:

Start cruise gross weight	40,519 lb
Cruise pressure altitude	15,000 ft
Cruise true airspeed	300 KTAS
Temperature (figure A1-6)	5.5°F
Cruise true Mach no. (figure A1-5)	0.479
Cruise calibrated airspeed (figure A1-5)	241 KCAS
Cruise indicated airspeed (figure A1-3)	243 KIAS
Drag index	1.25
Reference no. (sheet 1)	9.9
Specific range (sheet 2)	0.086 NM/lb
Cruise distance (150 - 2 - 18)	130 NM
Fuel used (NM ÷ NM/lb)	1,512 lb
Average cruise gross weight [40,519 - (1,512 ÷ 2)]	39,763 lb

Rereading figure A4-4, sheet 1, the following information is obtained:

Specific range	0.0865 NM/lb
Cruise distance	130 NM
Fuel used	1,503 lb
End cruise gross weight	39,016 lb

Change in Gross Weight During Combat

Initial combat gross weight	39,016 lb
Combat true airspeed	300 KTAS
Combat pressure altitude	500 ft

Temperature (figure A1-6)	57.2°F
Combat calibrated airspeed (figure A1-5)	298 KCAS
Combat indicated airspeed (figure A1-3)	300 KIAS
Combat power setting	MAXIMUM
Combat fuel flow (figure A6-2)	7,100 lb/hr
Combat time	30 min
Combat fuel allowance (figure A6-6)	3,550 lb
Bomb weight	3,030 lb
Ammunition weight (1,174 rounds x 1.1 lb expended per round)	1,291 lb
Flare weight	192 lb
Total weight loss during combat (3,550 + 3,030 + 1,291 + 192)	8,063 lb
Final combat gross weight (39,016 - 8,063)	30,953 lb

The time and distance to climb from 500 - 15,000 feet can be computed in the same manner as was used above to determine fuel. Thus:

Time to climb (3.3 - 0.3)	3 min
Distance to climb (13 - 1)	12 NM

Cruise Back to Base

Because the average cruise gross weight is unknown initially, it is necessary to proceed as was done for the outbound cruise, or:

Start cruise gross weight	30,653 lb
Cruise pressure altitude	15,000 ft
Cruise airspeed	300 KTAS
Cruise airspeed (from figures A1-3 and A1-5)	241 KCAS/ 243 KIAS
Cruise Mach no. (figure A1-5)	0.479
Drag index	0.40
Reference no. (figure A4-4, sheet 1)	9.1

Climb to Cruise Altitude

The aircraft drag index after combat and for the remainder of the mission is 0.40.

Start climb gross weight	30,953 lb
Pressure altitude (combat altitude)	500 ft
Drag index	0.40
Fuel used (SL to 500 ft)	20 lb
Cruise altitude	15,000 ft
Fuel used (SL to 15,000)	320 lb
Fuel used in climb from 500 - 15,000 ft (320 - 20)	300 lb

Specific range (sheet 2)	0.093 NM/lb
Cruise distance (150 - 12)	138 NM
Fuel used (NM ÷ NM/lb)	1,484 lb
Average cruise gross weight [30,653 - (1,484 ÷ 2)]	29,911 lb

Rereading figure A4-4 with the average cruise gross weight, the following information is obtained:

Reference no.	9.0
Specific range	0.0945 NM/lb
Cruise distance	138 NM

Fuel used	1,460 lb	Fuel used in climb	730 lb
End cruise gross weight	29,193 lb	Time to climb	9 min
Fuel Required for Mission		Distance to climb	37 NM
Start, taxi, takeoff, and acceleration to climb speed allowance	500 lb	Initial cruise gross weight	40,259 lb
Climb to 15,000 ft	470 lb	Cruise to Target (figure A4-3, sheets 1 and 2)	
Cruise to target	1,503 lb	As in the previous sample problem, the average cruise gross weight is not known initially. Therefore, it is necessary to proceed as was described in that problem and the results are as follows:	
Combat at 500 ft	3,550 lb	Drag index (outbound)	1.25
Climb from 500 - 15,000 ft	300 lb	Initial cruise gross weight	40,259 lb
Cruise back to base	1,460 lb	Cruise pressure altitude	20,000 ft
Landing reserve	2,000 lb	Cruise Mach no. (figure A4-3, sheet 1)	0.449
Total	9,783 lb	Cruise speed (figure A1-5)	204 KCAS/ 276 KTAS

An alternate mission profile for the HI-LO-HI mission is to climb to the optimum cruise altitude for a range of 150 nautical miles and cruise at long range cruise speed. The following example will illustrate this profile and technique, as in the previous HI-LO-HI mission.

Start, Taxi, Takeoff, and Acceleration to Climb Speed

Takeoff fuel allowance	500 lb
Distance (from brake release to climb speed)	2 NM
Time (from brake release to climb speed)	1 min

Climb to Optimum Cruise Altitude

Start climb gross weight	40,989 lb
Drag index	1.25
Optimum cruise altitude for 150 NM range (figure A4-1)	20,000 ft

Change in Gross Weight During Combat

Initial combat gross weight	39,149 lb
Combat pressure altitude	500 ft
Combat speed	300 KIAS/ 300 KTAS

Combat power setting	MAXIMUM	Cruise speed (figure A1-5)	180 KCAS/ 266 KTAS
Combat fuel flow (from figure A6-2)	7,100 lb/hr	Cruise speed (figure A1-3)	183 KIAS
Combat time	30 min	Specific range (figure A4-3, sheet 2)	0.125 NM/lb
Combat fuel allowance (from figure A6-6)	3,550 lb	Cruise distance (150 - 34)	116 NM
Total expended ordnance weight	4,513 lb	Fuel used (NM : NM/lb)	928 lb
Weight loss during combat	8,063 lb	Average cruise gross weight	30,017 lb
Final combat gross weight	31,086 lb	End cruise gross weight	29,553 lb

Climb to Cruise Altitude and Cruise Back to Base

Start climb gross weight	31,086 lb
Drag index (return leg)	0.40
Cruise altitude (figure A4-1)	25,000 ft
Fuel used (SL to 25,000 ft)	625 lb
Initial altitude	500 ft
Fuel used (climb from sea level to 500 ft)	20 lb
Fuel used in climb from 500 - 25,000 ft (625 lb - 20 lb)	605 lb

The time and distance to climb from 500 - 20,000 feet can be computed in a similar manner as was used above to determine fuel used, or:

Time to climb (8.3 min - 0.3 min)	8 min
Distance to climb (35 NM - 1 NM)	34 NM
Initial cruise gross weight	30,481 lb
Cruise pressure altitude	25,000 ft
Cruise Mach no. (figure A4-3, sheet 1)	0.442

Fuel Required for Mission

Takeoff allowance	500 lb
Climb to 20,000 ft	730 lb
Cruise at 20,000 ft	1,110 lb
Combat at 500 ft	3,550 lb
Climb from 500 - 25,000 ft	605 lb
Cruise at 25,000 ft	928 lb
Reserve	2,000 lb
Total fuel required	9,423 lb

**CLOSE AIR SUPPORT (CAS) MISSION,
LO-LO-LO**

This sample problem is similar to the HI-LO-HI combat mission described previously, except for the store loading, radius, and cruise altitude. The problem includes cruises (outbound/return) at 500 feet and 300 KTAS for a distance of 100 nautical miles.

Supplemental Data

a. The loaded gross weight with 11 pylons, full internal fuel, two LAU-88's on stations 3 and 9, four AGM-65's - two each on stations 3 and 9, one ALQ-119 on station 1, full ammunition, and a full load of flares,

is 41,821 pounds. The individual weight data, from figure A1-1, is tabulated below:

	<u>Wt ~ Lb</u>
A-10A operating weight	25,600
Full internal fuel	10,700
Two LAU-88's	930
Four AGM-65's	1,856
ALQ-119	576
1,174 rounds of 30mm ammunition	1,831
480 M-206 flare cartridges	328
Total aircraft gross weight	<u>41,821</u>

b. The usable fuel load is 10,700 pounds. The weight of the expendable ordnance is 3,339 pounds.

c. The drag index values of the aircraft at takeoff (outbound) and at landing (return), obtained from figure A1-1, are 3.58 and 2.53, respectively. The individual drag index values are as follows:

	DRAG INDEX	
	<u>Outbound</u>	<u>Return</u>
A-10A aircraft ~ 11 pylons	0.00	0.00
Two LAU-88's	1.22	1.22
Four AGM-65's	1.40	0.00
ALQ-119	0.91	0.91
480 M-206 flare cartridges (fully loaded)	0.05	-
480 M-206 flare cartridges (all fired)	-	0.40
Total aircraft drag index	<u>3.58</u>	<u>2.53</u>

Start, Taxi, Takeoff, and Acceleration to Climb Speed

Fuel used	500 lb
Distance (brake release to climb speed)	2 NM
Time (brake release to climb speed)	1 min

Climb to Cruise Altitude

Using figure A3-1, sheets 1 and 2:

Start climb gross weight	41,321 lb
Cruise altitude	500 ft
Drag index	3.58
Fuel used in climb	25 lb
Time during climb	0.4 min
Distance traveled during climb	1 NM
Gross weight at end of climb	41,296 lb

Cruise to Target (figure A4-4, sheets 1, 2, and 3)

As in the HI-LO-HI combat mission, the average cruise gross weight is not known initially. Therefore, it is necessary to proceed as described in that mission. The results are as follows:

Initial cruise gross weight	41,296 lb
Cruise speed	300 KTAS
Cruise Mach no. (figure A1-5)	0.455
Drag index	3.58
Reference no.	9.0
Specific range (figure A4-3)	0.054 NM/lb

Cruise distance (100 - 1.0 - 2.0)	97 NM
Fuel used (NM ÷ NM/lb)	1,796 lb
End cruise (initial combat) gross weight	39,500 lb

Change in Gross Weight During Combat

Initial gross weight	39,500 lb
Combat true airspeed	300 KTAS
Combat pressure altitude	500 ft
Combat calibrated airspeed (figure A1-5)	298 KCAS
Combat indicated airspeed (figure A1-3)	300 KIAS
Combat power setting	MAXIMUM
Combat fuel flow (figure A6-2)	7,100 lb/hr
Combat time	30 min
Combat fuel allowance	3,550 lb
Total (dispensed) ordnance weight	3,339 lb
Total weight loss during combat (fuel + ordnance = 3,550 + 3,339)	6,889 lb
Final combat gross weight (39,500 - 6,889)	32,611 lb

Cruise Back to Home Base

Initial cruise gross weight	32,611 lb
Cruise speed	300 KTAS
Cruise Mach no. (figure A1-5)	0.455
Drag index	2.53
Specific range (figure A4-3)	0.057 NM/lb

Cruise distance	100 NM
Fuel used (NM ÷ NM/lb)	1,755 lb
End cruise gross weight	30,856 lb

Total Fuel Required for Mission

Start, taxi, takeoff, and accelerate to climb speed	500 lb
Climb to 500 ft	25 lb
Cruise at 500 ft to target	1,796 lb
Combat at 500 ft	3,550 lb
Cruise at 500 ft to base	1,755 lb
Reserve	2,000 lb
Total fuel required	<u>9,626 lb</u>

As an alternative, the LO-LO-LO mission can be computed using long range cruise speed instead of 300 KTAS.

Ground Operations (same as first LO-LO-LO profile)

Climb to Cruise Altitude (same as first LO-LO-LO profile)

Cruise to Target (figure A4-3, sheets 1 and 2)

As in the previous combat missions, the average cruise gross weight is not known initially. Therefore, it is necessary to proceed as previously described. The final results are as follows:

Drag index	3.58
Start cruise gross weight	41,296 lb
Cruise pressure altitude	500 ft
Long range cruise Mach no.	0.325
Cruise calibrated airspeed (figure A1-5)	213 KCAS

Cruise indicated airspeed (figure A1-3)	215 KIAS	Average cruise gross weight 32,937 (1,390 ÷ 2)	32,242 lb
Specific range (figure A4-2, sheet 2)	0.066 NM/lb	End cruise gross weight	31,547 lb
Cruise distance (100 - 2.0 - 1.0)	97 NM	Total Fuel Required for Mission	
Fuel used (NM ÷ NM/lb)	1,470 lb	Start, taxi, takeoff, and accelerate to climb speed	500 lb
Average cruise gross weight [41,296 - (1,470 ÷ 2)]	40,561 lb	Climb to 500 ft	25 lb
End cruise (initial combat) gross weight	39,826 lb	Cruise at 500 ft to target	1,470 lb
Change in Gross Weight During Combat		Combat at 500 ft	3,550 lb
Initial combat gross weight	39,826 lb	Cruise at 500 ft to base	1,390 lb
Total weight loss during combat	Same as first LO- LO-LO profile	Reserve	2,000 lb
Final combat gross weight (39,826 lb - 6,889 lb)	32,937 lb	Total fuel required	<u>8,935 lb</u>
Cruise Back to Home Base		SAMPLE INFLIGHT DATA LOG	
Initial cruise gross weight	32,937 lb	Figure A9-1 presents a sample inflight data log illustrating the various mission inputs. The mission used as the sample is the HI-LO-HI close air support (CAS) mission flown at optimum altitude and long range cruise speed.	
Drag index	2.53	TAKEOFF AND LANDING DATA (T.O.L.D) CARD	
Cruise pressure altitude	500 ft	The following example illustrates the prep- aration of the takeoff and landing data card (figure A9-2). Takeoff and landing data are obtained from parts II and VIII, respectively. The takeoff gross weight is the gross weight with full fuel less the fuel allowance for ground operations. The landing weight immediately after takeoff is the takeoff weight less an estimated fuel allowance of 600 pounds for takeoff and return for landing.	
Cruise Mach no. (figure A4-3, sheet 1)	0.295	For the purpose of the sample problem, the conditions and calculations are as follows:	
Cruise calibrated airspeed (figure A1-5)	193 KCAS	Drag index	1.25
Cruise indicated airspeed (figure A1-3)	195 KIAS	Gross weight (full fuel)	41,489 lb
Specific range (figure A4-2, sheet 2)	0.072 NM/lb		
Cruise distance	100 NM		
Fuel used (NM ÷ NM/lb)	1,390 lb		

Runway heading	360° MAG	Takeoff index (figure A2-4)	9.6
Runway pressure altitude	1,000 ft	Takeoff ground run (figure A2-6):	
Runway temperature	+15°C	(13 kt headwind, 1% uphill)	2,900 ft
Wind	15 kt from 038° MAG	(13 kt headwind, no slope)	2,800 ft
Runway length	7,000 ft	(zero wind, 1 7/8 uphill)	3,400 ft
Runway slope	1% uphill	(zero wind, no slope)	3,300 ft
RCR (dry runway)	23	50-foot obstacle clearance distance (figure A2-7)	4,400 ft
Speed brake option	With speed brakes open 100%	RCR with no anti-skid (figure A2-9)	16
Flap position	7°	Critical field length, speed brakes open 100%, zero wind, 1% uphill (figure A2-10):	
The takeoff calculations are as follows:			
Taxi and ground operations (approximate)	500 lb fuel	(RCR = 23)	5,300 ft
		(RCR = 16)	6,175 ft
Takeoff gross weight (41,800 - 300)	40,989 lb	13 kt headwind, 1% uphill	
Headwind component (figure A2-15)	13 kt	(RCR = 23)	4,400 ft
		(RCR = 16)	5,000 ft
Single-engine rate of climb (at takeoff speed) (figure A2-3):		Refusal speed, speed brakes open 100% (figure A2-11)	
Flaps 7°, gear down	75 fpm	Zero wind (RCR = 23)	148 KIAS
Flaps 7°, gear up	475 fpm	Zero wind (RCR = 16)	128 KIAS
Flaps 0°, gear up	575 fpm	Continuation speed (figure A2-12)	
Takeoff speed (figure A2-2)	139 KIAS	Zero wind, 1% uphill	116 KIAS
Rotation speed (figure A2-2)	129 KIAS	13 kt headwind, 1% uphill	102 KIAS
Best single-engine climb speed (figure A3-5)	148 KIAS	Wheel brake energy limit (figure A2-13):	
Best single-engine rate of climb (figure A3-6)	110 fpm (gear down, flaps 7°)	Speed brakes closed	153 KIAS
		Speed brakes open 100%	> 190 KIAS

Acceleration check speed (figure A2-14) (13 kt headwind, 1% uphill) at 1,000 feet	88 KIAS	at 15 seconds	98 KIAS
		at 2,000 feet	115 KIAS
		at 20 seconds	120 KIAS

The landing conditions are as follows:

	<u>Landing Immediately After Takeoff</u>	<u>Final Destination Landing</u>
Landing gross weight	40,989 lb	29,553 lb
Runway pressure altitude	1,000 ft	Sea level
Runway temperature	+15 °C	+15 °C
Wind (headwind)	13 kt	10 kt
Runway slope	1% uphill	No slope
Runway length	7,000 ft	7,000 ft
RCR (with anti-skid)	23	23
RCR (with no anti-skid)	16	16
Speed brakes option	Closed	Open 100%
Flap position	0°	20°
Type approach/landing	Single engine	Normal

The landing calculations are as follows:

Final approach speed (figure A8-1)	161 KIAS	119 KIAS
Touchdown speed (figure A8-1)	142 KIAS	109 KIAS
Landing index (figure A8-2)	96.5	
Landing air distance (from 50 ft to touchdown) (figure A8-2)	1,330 ft	1,075 ft
Landing ground roll (figures A8-4, A8-3)	2,100 ft (RCR = 23) 6,200 ft (RCR = 16)	1,200 ft (RCR = 23) 2,050 ft (RCR = 16)

**SAMPLE INFLIGHT DATA LOG
HI-LO-HI COMBAT MISSION**

PHASE OF MISSION	POWER SETTING	POSITION	*FUEL USED - LB	TOTAL GROSS WEIGHT - LB	DISTANCE	TOTAL DISTANCE	TIME	TOTAL TIME	AIRSPEED	ALTITUDE - FT
						0		0		SL
GROUND OPERATIONS, TAKEOFF & ACCELERATE		START	500	41,489	2	2	1	1	-	SL
		END		40,989					200 KIAS	
CLIMB TO 20,000 FT	775°C ITT	START	730	40,259	37	39	9	10	200 KIAS	20,000
		END							180 KIAS	
CRUISE AT LONG RANGE SPEED AT 20,000 FT	PLF	START	1,100	39,149	111	150	24.1	34.1	206 KIAS	20,000
		END							300 KIAS	
COMBAT AT 500 FT 300 KTAS	MAX	START	3,550	35,599	0	150	30	64.1	300 KIAS	500
		END							300 KIAS	
DROP BOMBS FIRE AMMO RELEASE FLARES	-	START	[4,513]	31,086	0	150	0	64.1	-	500
		END							200 KIAS	
CLIMB FROM 500 - 25,000 FT	775°C ITT	START	605	30,481	34	116	8	72.4	170 KIAS	25,000
		END							179 KIAS	
CRUISE AT LONG RANGE SPEED AT 25,000 FT	PLF	START	928	29,553	116	0	26.1	98.5	179 KIAS	25,000
		END							-	
LANDING FUEL RESERVE	-	START	2,000	27,553	0	0	0	98.5	-	SL
		END							-	
		START								
		END								
		START								
		END								
		START								
		END								

*USABLE FUEL WEIGHT
INTERNAL 10,700 LB

[] STORE WEIGHT ONLY.

NOTE

- DATA BASIS: STANDARD DAY - ZERO WIND CONDITIONS.
- PLF ~ POWER FOR LEVEL FLIGHT.

Figure A9-1

SAMPLE TAKEOFF AND LANDING DATA CARD

	CONDITIONS	
	Takeoff	Landing
Gross weight	41,489 lb	29,553 lb
Runway length	7,000 ft	7,000 ft
OAT	15°C	15°C
Pressure altitude	1,000 ft	SL
Wind	13 kt headwind	10 kt headwind
Runway gradient	1% uphill	No slope
RCR	16 (no anti-skid)	23 (with anti-skid)

TAKEOFF

	% RPM
Fan speed	
Acceleration check	115 KIAS at 2,000 ft
Rotation speed	129 KIAS
Go, no-go check	
Refusal speed (dual-engine)	140 KIAS
Takeoff	140 KIAS at 3,000 ft
Single-engine rate of climb, gear down	75 fpm at 110 fpm at 139 KIAS 148 KIAS

LANDING

	Immediately After Takeoff	Normal
Speed brakes	Closed	Open 100%
Gross weight	40,989 lb	29,553 lb
Final approach speed	161 KIAS (single-engine)	119 KIAS
Touchdown speed	142 KIAS	109 KIAS
Ground roll:		
RCR = 23	2,100 ft	1,200 ft
RCR = 16	6,200 ft	2,050 ft
Min RCR	16	16
Single-engine rate of climb		

Figure A9-2

